

Specialists in CCTV, Hi-Tech Spy Equipment & Surveillance Devices



Vol. 129



BOLIDE

TECHNOLOGY GROUP



ISO 9001:2008
Certified



BOLIDE
TECHNOLOGY GROUP

Bolide Technology Group, Inc. is a world wide major manufacturer and ISO 9001:2008 certified Distributor of CCTV surveillance products and accessories. With a prestigious history of over 15 years offering high-quality, cutting edge products along with exceptional customer service, Bolide has become one of the fastest growing companies and most sought after suppliers in the industry.

Bolide provides a complete line of CCTV equipment from cameras, Digital Video Recorders, Matrix Systems and Monitors to accessories such as Cables, Connectors and Power Supplies. Moreover, Bolide continues to add new technology to its already extensive line of CCTV products & accessories to meet the constantly growing demand of its clients and partners around the globe.

From its impressive new state of art 26,000-square-foot headquarters located in Southern California and through a responsive network of sales representatives across the states, Mexico and Latin America, Bolide offers the best valued high performance security products in the market. Our mission is to provide our partners the best selection of the highest quality products with outstanding customer service.

Mission Statement:

“ Bolide Technology Group, Inc. strives to provide quality products and services to meet and exceed customer satisfaction. ”



Visit us today: <http://www.bolideco.com>

Toll Free: (800) 355-0895

BOLIDE TECHNOLOGY GROUP

468 South San Dimas Ave.
San Dimas, CA 91773
Toll Free: 800-355-0895
Tel: 909-305-8889 | Fax: 909-305-0999

Technical Support: 909-305-8889
Toll Free: 800-355-0895

Email: sales@bolideco.com
Website: <http://www.bolideco.com>



Index

- Industrial PTZ System • Mini High Speed Dome Cameras • Keyboard Controllers • Vandal Proof Speed Dome Cameras • Advanced Matrix Control System • Coaxial Converters • RS485 Bus Distributor

P.1 ~ P.16

CCTV Systems



- H.264 Standalone DVRs • MPEG4 Standalone DVRs • BIC Series 64-Channel Real Time PC-Based DVRs • LPD Software

P.17 ~ P.22

Digital Video Recorder



- Monitor Wall • Security Grade LCD Monitors • CRT Monitors

P.23 ~ P.26

Security Monitors



- Board Cameras • Bullet Cameras • Infrared Bullet Cameras • Professional Box Cameras • WDR Cameras • License Plate Cameras • Vandal Proof Dome Cameras • WAN/LAN Box Cameras

P.27 ~ P.44

CCTV Cameras



- Quad Processor • Mobile Digital Video Recorders • Portable Digital Video Recorders

P.45 ~ P.46

Observation System



- Telephone Recorder • Portable Digital Recorder • Telephone Bug Detectors • Wireless Audio System

P.47 ~ P.48

Telephone & Audio Devices



- Premade Hidden Cameras • Hidden Camera Packages • Wireless Camera Packages • SD Card Covert Cameras • USB Nanny Cameras

P.49 ~ P.51

Covert Cameras



- Professional Cables • Professional Lens • Mega Pixel Lens • CCTV Aspherical Vari-Focal Lens • Board Lens • Fixed Lens • Power Supplies • CCTV Connectors

P.52 ~ P.58

Parts & Accessories



Quality doesn't have to be so costly...



CCTV Systems

CCTV Systems

Digital
Video Recorders

Security Monitors

CCTV Cameras

Observation Systems

Telephone &
Audio Devices

Covert Cameras

Parts &
Accessories

PTZ Cameras



Industrial PTZ

BC2002/AT88 "EVO"

560x Zoom Advanced Positioning Camera

Features:

- OSD Menu for easy position programming
- Built-in Mechanical IR-Cut Filter
- Programmable schedule functions
- 220 presets with title
- Auto running function:
 - 4 panning, 4 sequences and 4 patterns
- Temperature and Coordination display
- 9 Language OSD Menu (Spanish, German, Italian etc.)
- Multi-protocols built-in Pelco D/P/C, Bosch, AD, VCL etc.
- -77° to 40° Tilt, 360° Continuous Pan

Specifications:

• Camera Specifications

Sync Systems	Internal
Image Sensor	1/4" Sony Exview HAD CCD
Scan System	2:1 Interface
Resolution	520TVL, 0.1 lux (B/W), 0.5 lux (Color)
Iris	Auto/Manual
Focus	Auto/Manual
Zoom Ratio	560x (Optical 35x, Digital 16x)
Focal Length	F = 3.6mm ~ 126mm
Aperture (F)	F1.6 ~ F4.2
BLC	Auto
White Balance	Auto
S/N Ratio	More than 50dB
Video Output	1.0±0.2Vp-p BNC
Interface	RS485/RS422, Bi-phase, Manchester, Pelco-Coaxitron
Multi-Protocol	Pelco D/P/C, AD, VCL, Vicon, Kalatel, Diamond etc.

• Electrical

Input Power	24VAC, 50/60Hz
Power Consumption	60W
Working Voltage	24VAC, 21W (Heater, Fan)
Protection	4000V video, Data, Power Lightning Proof

• Environment

Housing	IP66 Rated
Protection	Sun Shield, Auto Running Defroster, Heater, Fan, Wiper
Operating Temp.	-40°C~60°C
Operating Humidity	0-90%
Operation Wind Speed	90KM/hr
Withstand Wind Speed	130KM/hr
Withstand Rain Fall	4mm/Min
Water Jet	Available with relay out

• Mechanical

Horizontal Movement	Continuous 360° pan
Vertical Movement	-77° - 40° tilt
Manual Pan Speed	0.1° - 70° /s
Manual Tilt Speed	0.1° - 50° /s
Preset Speed	140°/s
Preset Accuracy	0.1°
Net Weight	9.6KG
Max load	5KG



CCTV Systems

CCTV Systems

Digital Video Recorders

Security Monitors

CCTV Cameras

Observation Systems

Telephone & Audio Devices

Covert Cameras

Parts & Accessories

Industrial PTZ

High resolution DSP 35x Optical / 16x Digital Zoom, Day/Night camera with 0.1 lux low illumination and features Mechanical IR Cut Filter

Weather-proof housing with thermostat, heater, fan, sun-shield defroster, and wiper

Stepping motor ensures 0.1 position accuracy and allows stable movement eliminating vibrations even in magnified zoom position

Multi-protocols, OSD menu, preset pattern, auto sequence, auto panning etc.

High quality slip ring ensures 360° continuous pan with more than 10 million times life time

The Bolide BC2002-AT88 Advanced PTZ Positioning System is an asset to any Airport, Border Defense, Custom/Port Authorities, as well as Highway & Urban Surveillance. We made it a priority to design the BC2002-AT88 to withstand all extreme weather conditions such as strong winds, rains & temperature differences. Once the BC2002-AT88 is installed it is a dependable, long term, maintenance free surveillance solution.

Bolide's BC2002-AT88 Advanced PTZ Positioning System integrates both variable and high speeds allowing smooth, stable and continuous control. The BC2002-AT88 Advanced PTZ Positioning system includes High Speed Decoder, PTZ plate, IOP, built-in heater, window defroster, sun shield, and thermal insulation materials.

BC1009/SPDN3000

560x Mechanical Day & Night IR Cut Filter PTZ Camera

Features:

- 1/4" Sony Ex-View HAD CCD
- 520 TV Lines Resolution
- 0.1 lux (Mono), 0.5 lux (Color)
- 560x Zoom (35x Optical, 16x Digital)
- Mechanical IR Cut Filter
- Built-in On-Screen-Display
- Support Multi-Protocol Pelco D, Pelco P and more
- RS485 Communication bus
- Presets, Tours, Patterns, Auto-scan and more

Specifications:

Sync System	Internal/External (Line Lock)
Image Sensor	1/4" Sony Ex-View HAD CCD
Resolution	520 TVL
Sensitivity	0.1 lux (Mono), 0.5 lux (Color)
Iris	Auto/Manual
Focus	Auto/Manual
Zoom	560x (35x Optical, 16 Digital)
Video Output	1.0±0.2 Vp-p
S/N	More than 48dB
White Balance	Auto/Manual
BLC	Off/Auto
Aperture (F)	F1.6~F4.2
Focal Length	F=36~126mm
Pan/Tilt Speed	0.5° ~ 160°/s
Preset Speed	> 300° /s
Rotation	Pan 360°,Tilt 0°~90°
Auto Flip	Rotates 180° at the bottom
Zoom Speed	5s/8s (Wide/Tele)
Preset	80 with Titles
Auto Pan	355° Programmable
Display Area	8 with Titles
Preset Tour	4
Pattern	4
Temperature	-40°C ~ 70°C
Humidity	0~95%
Protection Grade	IP 66 Outdoor Housing
Power Supply	24VAC
Power Consumption	50W
Receiver	Built-in
Video Output	Female BNC/UTP
Communication Data	RS485/422, Coaxial Bi-phase, Manchester Code
Baud Rate	2400/4800/9600/19200bps
ID Range	1 ~ 254
Weight	2.5kg



CCTV Systems

CCTV Systems

Digital
Video Recorders

Security Monitors

CCTV Cameras

Observation Systems

Telephone &
Audio Devices

Covert Cameras

Parts &
Accessories

PTZ Cameras

BC1009/SPJN70, BC1009/SPJN80

SPJN Series - 5" In/Outdoor Color 352x Zoom Speed Dome

Features:

- 22x optical color DSP camera with 16x digital zoom
- Sensitivity as low as 0.06 lux; Resolution up to 520TVL
- 4 privacy zone masking & 8 programmed zones
- Auto Running through OSD Menu directly
- Built -in Memory to Store 80 Presets with Titles setting
- Auto scan, home position ,4 Cruise Tours & 4 Pattern Tours
- Built-in Multi-protocol setting such as Pelco, Vicon, VCL and more...

Specifications:

Sync System	Internal
Image Sensor	1/4" CCD
Resolution	520 TVL
Sensitivity	0.06 lux
Iris	Auto/Manual
Focus	Auto/Manual
Zoom	352x (22x Optical, 16 Digital)
Video Output	1.0±0.2 Vp-p
S/N	More than 50dB
White Balance	Auto/Manual
BLC	Off/Auto
Aperture (F)	F1.6~F3.8
Focal Length	F = 4~88mm
Angel of View	Wide 47° / Tele 2.2°
Pan/Tilt Speed	0.5° ~ 160°/s
Preset Speed	> 300° /s
Rotation	Pan 360°,Tilt 0°~90°
Auto Flip	Rotates 180° at the bottom
Zoom Speed	3.9s/6.3s (Wide/Tele)
Preset	220 with Titles
Auto Pan	355° Programmable
Display Area	8 with Titles
Privacy Masking	4
Preset Tour	4
Pattern	4
Temperature	-40°C ~ 70°C
Humidity	0~95%
Protection Grade	IP66 Outdoor Housing (JN70) / Indoor Housing (JN80)
Power Supply	24VAC
Power Consumption	50W
Receiver	Built-in
Video Output	Female BNC/UTP
Communication Data	RS485/422, Coaxial Bi-phase, Manchester Code
Baud Rate	2400/4800/9600/19200bps
ID Range	1 ~ 254
Weight	3.2kg



Indoor Housing: BC1009/SPJN80



BC1009/PTZG3

3rd Generation High Speed PTZ Camera

Features:

- Heavy-Duty Outdoor PTZ Camera
- 360° pan and tilt range (Auto flip)
- 35x Optical Zoom / 16x Digital Zoom
- 1/4" Sony Exview HAD CCD with 520 TV Lines Resolution
- Scheduled action setting (4 schedules)
- Aluminum-Alloy construction
- Day/Night Mode
- Built-in multiple protocol
- OSD Menu
- Weather-Proof with IP66 rated housing

Specifications:

Sync System	Internal/External (Line Lock)
Image Sensor	1/4" Sony Ex-View HAD CCD
Resolution	520 TVL
Sensitivity	0.1 lux (Mono), 0.5 lux (Color)
Iris	Auto/Manual
Focus	Auto/Manual
Zoom	560x (35x Optical, 16 Digital)
Video Output	1.0 Vp-p / 75ohm
S/N	More than 48dB
White Balance	Auto/Manual
BLC	Off/Auto
Aperture (F)	F1.6~F4.2
Focal Length	F=3.6~126mm
Pan/Tilt Speed	0.5° ~ 160°/s
Preset Speed	> 300° /s
Rotation	Pan 360°, Tilt 0°~90°
Auto Flip	Rotates 180° at the bottom
Zoom Speed	5s/8s (Wide/Tele)
Privacy Masking	N/A
Temperature	-4°F ~ 140°F
Humidity	0~95%
Protection Grade	IP66 Outdoor Housing
Power Consumption	50W
Receiver	Built-in
Video Output	Female BNC
Communication Data	RS485/422, Coaxial Bi-phase, Manchester Code
Baud Rate	2400/4800/9600/19200bps
ID Range	1 ~ 254
Weight	2.5kg



**This camera features snap-on installation.
No extra cable or screws required.**

CCTV Systems

CCTV Systems

Digital
Video Recorders

Security Monitors

CCTV Cameras

Observation Systems

Telephone &
Audio Devices

Covert Cameras

Parts &
Accessories

WDR High Speed PTZ Camera

BC1009/PTZWD

Wide Dynamic Range High Speed PTZ Camera

Features:

- Heavy Duty Outdoor PTZ Camera
- 360° pan and tilt range (Auto flip)
- 36x Optical Zoom / 12x Digital Zoom
- 1/4" Sony Ex-View CCD with 520 TV Lines Resolution
- Scheduled action setting (4 schedules)
- Aluminum-Alloy construction
- Wide Dynamic Range built-in with IR cut-filter
- Built-in multiple protocol
- OSD Menu
- Weather-Proof with IP66 rated housing

Specifications:

Sync System	Internal
Image Sensor	1/4" Sony Ex-View HAD CCD
Resolution	520 TVL
Sensitivity	1/60 s mode: 1.4 lux (typical) (F1.6, 50 IRE) 1/4 s mode: 0.1 lux (typical) (F1.6, 50 IRE)
Iris	Auto/Manual
Focus	Auto/Manual
Zoom	432x (36x Optical, 12 Digital)
Video Output	1.0 Vp-p / 75ohm
S/N	More than 50dB
White Balance	Auto, ATW, Indoor, Outdoor, Manual
BLC	Off/Auto
Wide Dynamic Range	On/Off
Privacy Masking	24
Aperture (F)	F1.6~F4.5
Focal Length	F=3.4~122.4mm
Pan/Tilt Speed	0.5° ~ 160°/s
Preset Speed	> 300° /s
Rotation	Pan 360°,Tilt 0°~90°
Auto Flip	Rotates 180° at the bottom
Electronic Shutter	1/1 to 1/10,000 s, 22 steps
Privacy Masking	Auto, ATW, Indoor, Outdoor, One-push, Manual
Temperature	-4°F ~ 140°F
Humidity	0~95%
Protection Grade	IP66 Outdoor Housing
Power Consumption	50W
Receiver	Built-in
Video Output	Female BNC
Communication Data	RS485/422
Baud Rate	2400/4800/9600/19200bps
ID Range	1 ~ 254



**This camera features snap-on installation.
No extra cable or screws required.**

Motion Tracking PTZ Camera

BC1009/PTZAMT

High Speed Wide Dynamic PTZ Camera with Motion Tracking

Features:

- Heavy Duty Outdoor PTZ Camera
- 360° pan and tilt range (Auto flip)
- 36x Optical Zoom / 12x Digital Zoom
- 1/4" Sony Ex-View CCD with 520 TV Lines Resolution
- Scheduled action setting (4 schedules)
- Aluminum-Alloy construction
- Wide Dynamic Range built-in with IR cut-filter
- Built-in multiple protocol
- OSD Menu
- Weather-Proof with IP66 rated housing

Specifications:

Sync System	Internal
Image Sensor	1/4" Sony Ex-View HAD CCD
Resolution	520 TVL
Sensitivity	1/60 s mode: 1.4 lux (typical) (F1.6, 50 IRE) 1/4 s mode: 0.1 lux (typical) (F1.6, 50 IRE)
Iris	Auto/Manual
Focus	Auto/Manual
Zoom	432x (36x Optical, 12 Digital)
Video Output	1.0 Vp-p / 75ohm
S/N	More than 50dB
White Balance	Auto, ATW, Indoor, Outdoor, Manual
BLC	Off/Auto
Wide Dynamic Range	On/Off
Privacy Masking	24
Aperture (F)	F1.6~F4.5
Focal Length	F=3.4~122.4mm
Pan/Tilt Speed	0.5° ~ 160°/s
Preset Speed	> 300° /s
Rotation	Pan 360°,Tilt 0°~90°
Auto Flip	Rotates 180° at the bottom
Electronic Shutter	1/1 to 1/10,000 s, 22 steps
Privacy Masking	Auto, ATW, Indoor, Outdoor, One-push, Manual
Temperature	-4°F ~ 140°F
Humidity	0~95%
Protection Grade	IP66 Outdoor Housing
Power Consumption	50W
Receiver	Built-in
Video Output	Female BNC
Communication Data	RS485/422, Coaxial Bi-phase, Manchester Code
Baud Rate	2400/4800/9600/19200bps
ID Range	1 ~ 254

**This camera features snap-on installation.
No extra cable or screws required.**



CCTV Systems

Infrared PTZ Cameras

BC1009/IDIR "WALL-I"

Heavy Duty Outdoor Night Vision PTZ Camera

Features:

- Heavy Duty Outdoor PTZ Camera
- 360° pan and tilt range (Auto flip)
- Built-in High Power IR: Range up to 200ft
- 35x Optical Zoom / 16x Digital Zoom
- 1/4" CCD with 520 TV Lines Resolution
- Scheduled action setting (4 schedules)
- Aluminum-Alloy construction
- Day/Night Mode
- Wiper function
- Built-in multiple protocol
- OSD Menu
- Weather-Proof with IP66 rated housing

Specifications:

Image Sensor	1/4" CCD
Synchronization	Internal
Video Output	1.0Vp-p / 75 Ohms
Horizontal Resolution	520TVL
S/N Ratio	≥ 48dB
Minimum illumination	0 Lux (Led On)
Focal & Iris	Auto / Manual
Electronic Shutter	1~1/10,000s, 1/3~1/10,000s
Protective Housing	IP66 Rated
Zoom ratio	35 Optical Zoom, 16x Digital Zoom
White Balance	Auto
BLC	ON/OFF
Aperture	F1.6 ~ F4.2
Focal Length	F=36 ~126mm
Panning range	360° continuous
Pan Speed	0.4°-80°/sec
Tilt Range	-90°~90°
Tilt Speed	0.4°-60°/sec
Communication	Multi-protocol
Baud Rate	2400, 4800, 9600, 19200
Controls	Pan/Tilt
Presets	128 preset positions
Auto Pan	ON/OFF
Shock	≥ 4G
Power Source	IR: AC24V (45W)
Operating Temperature	-40°C-60°C
Weight	6Kg
IR Effective Range	Up to 200ft

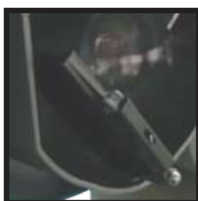

Wiper Function

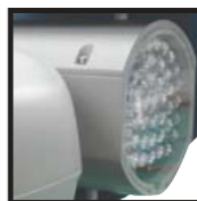

High Power IR - Up to 200 FT



Tilt Range: -90°~90°

Mini PTZ Cameras

CCTV Systems

Digital
Video Recorders

Security Monitors

CCTV Cameras

Observation Systems

Telephone &
Audio Devices

Covert Cameras

Parts &
Accessories

BC1009/PTZMINI

100x Zoom Mini Speed Dome Camera

Specifications:

Sync System	Internal
Image Sensor	1/4" SONY (Interline transfer) CCD
Resolution	500 TVL Color 570 TVL B/W
Sensitivity	0.7 lux Color 0.02 lux B/W
Iris	Auto/Manual
Focus	Auto/Manual
Zoom Ratio	100x (Optical 10x, Digital 10x)
Scan System	2:1 Interlacing
S/N	More than 50dB
White Balance	Auto/Manual
BLC	Off/Auto
Focal Length	f=3.8~38mm
Privacy Function	On/Off (32 zones)
Day & Night Function	Mechanical IR Cutter
Standard Features	BLC, Gain Control, White Balance
Electronic Shutter Speed	1/60 ~ 1/120,000 sec, Flicker less
Pan/Tilt Speed	0.5° ~ 120°/s
Pan Range	360°
Tilt Range	0° - 90°
Zoom Speed	1.67sec (Wide to Tele)
Receiver	Built-in
Communication Interface	RS485
Baud Rate	2400/4800/9600
ID Range	1~254
Size	165mm(W) x 152mm(H)
Power	12VDC, 2.5A



Features:

- 1/4" SONY (Interline Transfer) CCD
- 500 TV Lines Resolution
- 0.7 lux/F1.8 (Color), 0.02 lux/F1.8 (B/W)
- 100x Zoom (10x Optical, 10x Digital)
- Mechanical IR Cut Filter Day and Night Function
- Built-in On-Screen-Display
- Support Multi-Protocol Pelco D, Pelco P and more
- RS485 Communication bus
- IP67 Rated Weather-proof Housing



BC1009/PTZMINI-S

10x Zoom Mini Speed Dome Camera

Specifications:

Sync System	Internal
Image Sensor	1/4" (Interline transfer) CCD
Resolution	550 TVL
Sensitivity	0.01 lux at F1.2
Zoom Ratio	10x Optical Zoom
S/N	More than 50dB
BLC	Off/Auto
Electronic Shutter Speed	1/4 ~ 1/10,000 sec, 20 Steps
Pan/Tilt Speed	0.5° ~ 120°/s
Communication Interface	RS485
Gain	Auto/Manual
AE Control	Auto, Manual, Priority Mode, Bright
Display Function	Mode Display, Time/Date, Title
Video Output	1.0 Vp-p (Sync Negative) and Y/C

Optional:

Corner /Pole Mount Bracket



Features:

- 1/4" SONY (Interline Transfer) CCD
- 550 TV Lines Resolution
- 0.01 lux/F1.2
- 10x Optical Zoom
- Built-in On-Screen-Display
- Support Multi-Protocol Pelco D, Pelco P and more
- RS485 Communication bus
- IP67 Rated Weather-proof Housing

CCTV Systems

CCTV Systems

Matrix System

DR-3207

Matrix Video Switcher / System Controller

DR-3207 Matrix unit supports 32 video input and 7 monitor outputs. 5 units can be combined for system expansion, and it allows connections for up to 8 keyboards and 1 external computer for multiple controlling sites. It supports powerful alarm handling, 1024 recent alarm recording, 30 tours sequence switch with up to 6400 steps switching and 16 groups tour switch. Macro command function enable the system to work conveniently.



Features:

- Up to 8 Keyboards & 1 Multi-media PC controlling
- A Variety of tour patterns provide the most effective monitoring
- Sequence tour Switch: 30 tours available, up to 640 steps for each tour
- Group tour Switch: 16 groups available, with maximum 64 steps for each group
- Each Camera Sequence Scan is independent
- Powerful Alarm Handling
- 5 Matrix units can be combined for system expansion
- Video Synchronizing makes the video switching easy



Specifications:

Video Inputs - Standard	32
Video Inputs - Looping	32
Video Outputs	7
Alarm Inputs	32
Alarm Outputs	4
Bandwidth (-3dB)	8MHz
S/N Ratio	More than 52dB
Differential Gain	< 0.6%
Differential Phase	1.1
Insert Gain	< ± 0.5dB
Adjustment Channel Isolation Degree	> 50dB
Adjustment Channel Crosswalk	< -40dB
Synchronous Nonlinear Distortion	1%
Luminance Nonlinear Distortion	1.5%
Video Cable Distance	Minimum cable with 75 ohms
Impedance	RG-59/U : less than 300mm
Input Voltage	AC110V
Power Consumption	< 30W
Operating Temperature	0°C ~ +40°C
Operating Humidity	0% - 90%

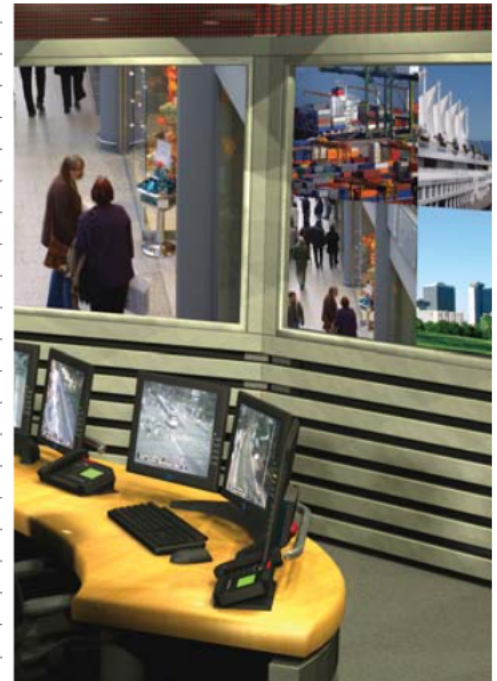

External Device Interface:

Video Inputs and Monitor Outputs	BNC
Looping Video Connection	Two 34-pin ribbon connector
Keyboards	Four 6-pin RJ-11 ports to connect keyboards
RS485 Port	Removable screw terminal block to connect groups of 8 RS485 Cable (0.5mm twisted-pair), can be up to 1200m long
RS-232 Port	For external PC or control interface: 9-pin D-type connector
Alarm Inputs	Removable screw terminal connectors

Digital Video Recorders

Security Monitors

CCTV Cameras

Observation Systems

Telephone & Audio Devices

Covert Cameras

Parts & Accessories

BE-8000

Advanced Network Matrix Video Switcher / System Controller

Features:

- Built-in modularized high-capability MPU; Up to 32 matrixes integrate over Ethernet
- Compact design; High-capability of inputs and outputs
- Low power consumption; less than 120W for single bay full duty running
- High stability and reliability
- Hot swappable; Plug and play for video input/output card; High Stability
- Low channels crosstalk
- Modularized design; keyboard, distributor, alarm input and alarm output are independent modules cooperate over Ethernet
- Detect and assign IP to devices automatically; Real time non-delay remote control
- Independent internal video channel for system setting. Keyboard and PC settings are available
- 64 channels Chinese and English character overlay
- Power sync switching; Adjustable sync phase (multiple of 60 degree)
- Isolated video channels; high anti-interference capability
- Ethernet hierarchy; Flexible and intelligent system integration
- Single Matrix bay configuration: Max 272 channel inputs; Max 64 channel outputs; Max input configuration: 272 X 16; Max output configuration: 224 X 64
- Four Matrix bay configuration: Max 1024 channel inputs; up to 64 channel outputs; Max input configuration & Max output configuration: 1024 X 64
- Max 4096 video input through Ethernet.



Specifications:

Output Impedance	75 (BNC ohm)
Insert Gain	0.5dB
S/N Ratio Weighted	52dB
Adjacent Channel Isolation Degree Weighted	60dB
Adjacent Channel Crosstalk Weighted	50dB
Frequency Characteristics	50Hz 8MHz
DC Level Video Signal	About 0.4 0.6V
KB/Receiver Controlling Time	20ms (Typical)
Switch	Complete switching of cross-point matrix
Switching Speed	20ms (NTSC)
Video Input	BNC 16 1024 Video Inputs
Video Output	BNC 16 64 Video Outputs
RS232 Port	One RS232 Local PC Port
Baud Rate bps	9600/19200/38400
Ethernet Port	10M
OSD Display	Date/Time, Monitor Title, Camera No. and Title
Character	Common English Characters
Synchronous Phase	Power Sync, Adjustable Sync Phase (multiple of 60 degree)
Data Storage	Various settings and configuration data can last at least 5 years when power-off
Dimension	312mm x 483mm x 420mm
Power Supply	220VAC/50Hz or 110VAC/60Hz
Weight	15kg

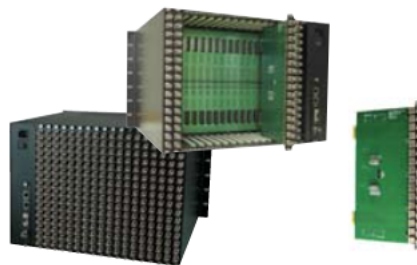
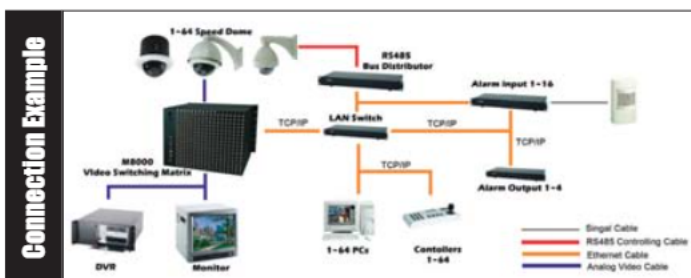

CCTV Systems

CCTV Systems

PTZ Protocol Control Options

BE-485BUS/8, BE-485BUS/16

RS485 Bus Distributor

Features:

- TVS 1500W lightning proof and 1500mA surge proof
- Highly insulated input and output channels
- RS485 control, baud rate 2400, 4800, 9600bps
- 16-channel outputs, each channel supports transmitting distance of 1200m (0.56mm twisted-pair wire)
- 4, 8, 12 channels output optional



Specifications:

Power Supply	DC12V 2A
Power Consumption	less than 24W
Receiving Controlling Mode	RS485, RS232
Transmitting Mode	RS485
Max Transmitting Distance	1200mm (0.5mm Twisted Pair)
Operating Temperature	32°F ~ 122°F
Storage Temperature	14°F ~ 122°F
Dimensions	430x210x44mm
Weight	2.85kg



BE-DR-AD300, BE-DR-AD300/16

Coaxial Converter

Features:

- Receiving Interface: Built-in RS485/RS422, Manchester, BI-Phase Code
- Transmitting output (BNC, with video and controlling data)
- With power supply / receiving red LED and signal transmitting green LED
- Multi-protocol options available by setting DIP switches such as: Pelco-D, Pelco-P, Kalatel, Panasonic, VCL, Bosch, American Dynamics and more...
- 120ohm jumper in receiving interface
- 400V video lightning resistant



Specifications:

Model	BE-DR-AD-300	BE-DR-AD-300/16
Output Channel (s)	1	16
Supply Voltage DC	DC9V +20%	DC12V +20%
Power	less than 1W	less than 6W
Weight	180g	2kg
Receiving Controlling Mode	RS485/RS422/Manchester/BI-Phase	
Receiving Baud Rate	4800/9600/19200bps	
Receiving Baud Rate	32K bps (Manchester / BI-Phase)	
Transmitting Mode	Coaxial Video & Control Data	
Max. Transmission Distance	300m (0.5mm Twisted Pair Cable)	
Operating Temperature	32°F ~ 122°F	
Storage Temperature	14°F ~ 122°F	
Dimension (mm)	143x67.5x34.5	482x160x48.5

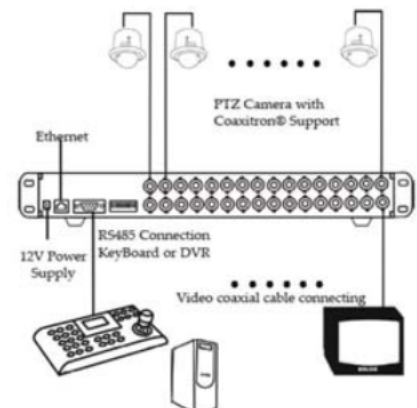

Digital Video Recorders

Security Monitors

CCTV Cameras

Observation Systems

Telephone & Audio Devices

Covert Cameras

Parts & Accessories

PTZ Controller

CCTV Systems

Digital Video Recorders

Security Monitors

CCTV Cameras

Observation Systems

Telephone & Audio Devices

Covert Cameras

Parts & Accessories

BE-KB03

3 Axis Computerized Surveillance Controller

Features:

- Long distance control : 1200m
- Controls up to 255 Bolide Devices
- 3-axis joystick design
- LCD Display with error information
- Up to 4 keyboards can be connected in one control system

Specifications:

Communication Port	Interface: RS-485 / RS-422
	Connector: DJ21/RJ11, RS232, DB9
	Baud Rate: 2400/4800/9600/19200bps
System Settings	One 8-bit DIP Switcher
Display	128x64 Dot Matrix, 20x8 Characters
P/T/Z Control	left/right: up/down
	Iris: up/down
Switch/Control	Focus: far/near
	Zoom: in/out
	Save/Call Preset, Auto-Scan, Pattern, Tour
Joystick	Three Axis (Left, Right, Zoom)
Power Supply	DC 9V-15V
Power Consumption	5W
Dimension	360x160x45mm



BE-KB02

3 Axis Computerized Surveillance Controller

Features:

- 3-Axis Joystick control (PTZ)
- Compact, Ergonomic Design
- Various Speed for PTZ control
- LCD Screen with backlight
- Multi Protocol Built-in



Specifications:

Communication Port	RS-485/RJ45
Baud Rate	2400/4800/9600bps
System Settings	DIP Less OSD Software
P/T/Z Control	left/right: up/down
	Iris: up/down
	Focus: far/near
	Zoom: in/out
	Save/Call Preset/Tour/Pattern
Joystick	Three Axis (Left, Right, Zoom In/Out)
Power Supply	DC 12V 200mA
Dimension	218x180x55.5mm

BE-KB03E

2 Axis Computerized Surveillance Controller

Features:

- Compact Design, attractive appearance
- Control Pan/Tilt, Focus, Zoom, Iris
- 1200m maximum range
- Controls up to 32 PTZ Dome Cameras



Specifications:

Communication Port	RS-485
Baud Rate	2400/4800/9600bps
System Settings	One 8-bit DIP Switcher
P/T/Z Control	left/right: up/down
	Iris: up/down
	Focus: far/near
	Zoom: in/out
	Save/Call Preset
Joystick	Two Axis (Left, Right)
Power Supply	DC 12V 500mA
Dimension	188x97x70mm

Digital Video Recorders

CCTV Systems

Digital Video Recorders

Security Monitors

CCTV Cameras

Observation Systems

Telephone & Audio Devices

Covert Cameras

Parts & Accessories

Standalone DVR

Bolide's SVR series network digital video recorder is our 3rd generation flagship digital surveillance system. Real Time OS and embedded MCU which supports both features of digital video recorder (DVR) and digital video server (DVS) and can be used as a standalone system or be used to build a powerful network.

Main Features

- H.264 video compression algorithm
- Supports CIF real time compression, 2CIF, and up to 4CIF
- Provides sub stream for cell phone surveillance. If you enable sub stream and 2CIF compression maximum
- Supports multi-zone motion detection
- Supports mask function to mask sensitive area
- Supports view tampering alarm function for spiteful camera block
- Supports video signal loss alarm function
- Supports both constant bit rate and variable frame rate

Storage

- Supports SATA HDD
- Supports USB flash disk, USB hard disk and USB CD/DVD writer for backup

Preview & Playback

- Supports monitor BNC video output & VGA output
- Supports playback fast, slow, pause, forward, backward, frame by frame, etc
- Supports one channel playback

Network

- Supports TCP, UTP, RTP, Multicast, DHCP, etc
- Supports DDNS for Dynamic IP
- Remote parameters setup & upgrade DVR firmware
- Remote playback, download the recorded files in DVR
- Supports Internet Explorer for network preview

Central Management Software

- Supports up to 200 DVRs connections
- Streaming server for Multiple Client Connections
- Supports remote playback, local record and backup
- E-Map Function with alarm triggering



Digital Video Recorders

Standalone DVR

Compatible with most phone in the market.



SVR8004, SVR8008, SVR8016

3rd Generation H.264 Compression DVR

Features:

- Real-Time OS with Embedded MCU
- H.264 video compression algorithm
- Supports up to 4 Hard Drives
- DVD Quality (4CIF) recording
- Resolutions: 4CIF, 2CIF, CIF, QCIF
- Supports PTZ, TCP/IP, PPPoE, DDNS
- VGA Output and Alarm IN/OUT



CMS Central Management Software:

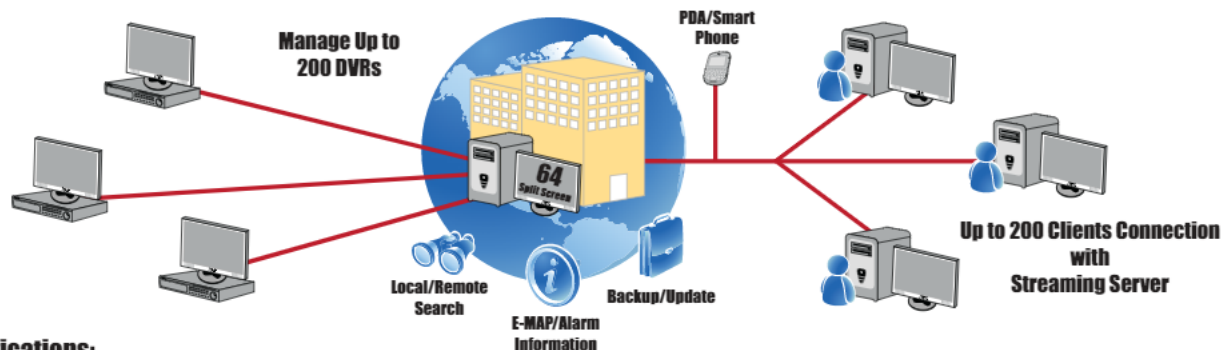

Specifications:

Model Number	SVR8004	SVR8008	SVR8016
Image Compression	3rd Generation H.264		
Preview Resolution	4CIF Real Time		
Playback Resolution	CIF/QCIF real time, 2CIF/4CIF not real time		
Video Input	4 BNC	8 BNC	16 BNC
Video Loop Out	4 BNC	8 BNC	16 BNC
Recording Resolution	4CIF (C1), QCIF, 2CIF, CIF, QCIF		
Recording Speed	CIF: 30fps/Channel 2CIF: 15fps/Channel 4CIF: 6fps/Channel	CIF: 30fps/Channel 2CIF: 15fps/Channel 4CIF: 6fps/Channel	CIF: 30fps/Channel 2CIF: 8fps/Channel 4CIF: 2fps/Channel
Stream Type	Video/Video & Audio	Video	Video/Video & Audio
Stream Bit Rate	32kbps ~ 2Mbps, self define		
Audio Input	4	N/A	4
Audio Compression Bit Rate	16Kbps	N/A	16kbps
Audio Compression	OggVorbis	N/A	OggVorbis
Network	1 RJ45 10M/100M UTP Port		
PTZ Port	1 RS-485 Port (T+, T-, R+, R-)		
HDD Interface	SATA		
VGA Interface	1 x VGA interface		
USB Interface	1 USB interface, USB1.1, can support USB flash memory, USB HDD and USB CD-R/W		
Alarm Input	4	8	16
Alarm Output	2	4	4
Power Supply	100~240VAC, 6.3A, 50~60Hz		
Power Consumption	20 - 42W (without HDD)		
Dimension	19" standard (450mm x 450mm x 95mm)		

Digital Video Recorders

S-Box Series

sweet temptation.

Bolide S-box series is
Irresistible, Enjoyable &
Affordable.



SVR9000S/T4

Advanced H.264 DVR with Cell Phone Streaming Server

Features:

- Real time recording and compressing video data
- Net transmitting: H.264 Compression for IE, support TCP/IP protocol, static IP/DHCP for four users
- Remote Alert when alarm is triggered
- Multiple record modes: continuous, motion detection, sensor triggered, time schedule etc.
- System self-recovery after power loss
- Supports IR remote control and PTZ control, backup HDD data via USB 2.0 port
- Cell Phone Streaming server built-in for remote viewing

Compatible with most phone in the market.



Model No.	SVR9000S-T4
Image Compression	H.264
Preview Resolution	D1 Real Time
Video Standard	NTSC
Video Input	4 BNC 1.0 Vp-p 75ohm
Video Output	1 x BNC, 1 x VGA
Max. Recording Resolution	30fps @ 720x480, 60fps @ 720x240, 120@ 320x240
Recording Quality	4-Level (Highest, High, Normal, Low)
Audio Input	4 inputs / 2 outputs
Audio Compression bit rate	ADPCM2 Codec
Network Protocol	TCP/IP, PPPoE, DHCP and DDNS
Web Transmitting Compression	H.264
HDD Interface	SATA up to 1024GB
PTZ Port	1 RS-485 Port
Power Source	DC12V, 3A
System Recovery	System auto recovery after power failure



Digital Video Recorders

S-Box Series

SVR9000S/T8, SVR9000S/T16

Advanced H.264 DVR with Cell Phone Streaming Server

Features:

- Net transmitting: H.264 Compression for IE, support TCP/IP protocol, static IP/DHCP for four users
- Remote Alert when alarm is triggered
- Multiple record modes: continuous, motion detection, sensor triggered, time schedule etc.
- System self-recovery after power loss
- Supports IR remote control and PTZ control, backup HDD data via USB 2.0 port
- Cell Phone Streaming server built-in for remote viewing

Model No.	SVR9000S-T8	SVR9000S-T16
Image Compression	H.264	
Preview Resolution	D1 Real Time	
Video Standard	NTSC	
Video Input	8 BNC 1.0 Vp-p 75ohm	16 BNC 1.0 Vp-p 75ohm
Video Output	1 x BNC, 1 x VGA	
Max. Recording Resolution	120fps @ 320x240	480fps @ 320x240
Recording Quality	4-Level (Highest, High, Normal, Low)	
Audio Input	1 input / 1 output	4 inputs / 2 outputs
Audio Compression bit rate	ADPCM2 Codec	
Network Protocol	TCP/IP, PPPoE, DHCP and DDNS	
Web Transmitting Compression	H.264	
HDD Interface	SATA, up to 1024GB	2 x SATA up to 1024GB
PTZ Port	1 RS-485 Port	
Power Source	DC12V, 3A	
System Recovery	System auto recovery after power failure	

SVR9032

32 Channel H.264 DVR with Built-in Matrix

Features:

- Built-in 32 x 4 Matrix output, 32 channel circular monitor
- MPEG4/H.264 Video compression algorithm, support CBR, VBR and adjustable frame rate
- Up to 4 channels simultaneously playback
- Supports 6 SATA HDDs and up to 2 TB each, with USB 2.0 port for backup
- Supports Multi-level user management
- Supports 2 Way communication

Model No.	SVR9032
Image Compression	MPEG4/H.264
Preview Resolution	D1 Real Time
Video Standard	NTSC/PAL
Video Input	32 BNC 1.0 Vp-p 75ohm
Video Output	2 x BNC, 1 x VGA
Max. Recording Resolution	960fps @ 320x240
Matrix Output	4 CH BNC
Recording Quality	5-Level (Super, Fine, Good, Normal, Low)
Audio Input/Output	16ch/1ch
Audio Compression bit rate	G.723/ADPCM
Voice Communication	Independent CH for 2-way communication
Network Protocol	TCP/IP, PPPoE, DHCP
Alarm Input/Output	12 inputs / 3 outputs
HDD Interface	6 x SATA, up to 2TB each
PTZ Port	RS-485 Port
Size	2U, 440x100x460 mm

Compatible with most phone in the market.



SVR9000S-T8



SVR9000S-T16



4 Channel Matrix Display

Digital Video Recorders

PC Based DVR

BIC 6000 Series

PC-Based H.264 Compression Real-Time DVR System

BIC6000 series uses fully optimized algorithm based DSP technology to implement video & audio real-time coding, active video & audio preview, motion detection and more. Video image is directly transmitted from board to display frame buffer and compressed stream data is also directly sent to host's memory. Data transfer does not need any intervention from the host computer processor, greatly saving resources of host computer's processor. One computer can support up to 64 channels video and audio input, parameters of each channel can be set independently.



Features:

- Supports a maximum 64 channels video and audio in
- The output video and audio streams are integrated to generate the synchronized H.264 stream. Video and audio coincide with each other from beginning to end when the stream is played back
- Supports the following resolution on every channel
FULL D1 (720x480), 4CIF (704x480), DCIF (528x320), 2CIF (704x240), CIF (352x240), QCIF (176x120)
- Supports multi-zone motion detection
- Supports local file Playback and time/date playback; Fast forward, Slow Motion, Pause, Frame by Frame etc.
- Supports watermark and E-map

Specifications:

Recording Speed	Real Time 30FPS/CH, up to 64 CH
Display Speed	Real Time Full D1 Resolution
Compression	H.264 Advanced Video Compression (Multicast)
Available Channel	Up to 64 CH
Compression Resolution	4CIF (704x480), DCIF(528x320), 2CIF(704x240) CIF(352x240), QCIF(176x120)
Audio Recording	Up to 64 CH
Audio Compression	OggVorbis, 16KHz
Authentication	Watermark
Time Stamp	Image Embedded With Date/Time Information
Display Frame Rate	Real-Time All Channels Simultaneously
Display Resolution	4CIF
Disconnection Detection	Watchdog Function
PTZ Support	RS-232, RS-422/485 Interface
Remote Connection	Client Software / Web Browser
Audio Monitoring	Yes
Search Mode	By Channel, Date & Time, Motion Detection, Events
Backup	Remote, CDRW, DVDRW, USB hard disk, or USB Flash drive

PC System:

Chipset	Intel chipset
CPU	Pentium Core 2 Duo 2.4GHz or better
RAM	512MB DDR2 or better
Storage	SATA HDDs
Video Display	ATI 256MB Video Card or better
OS	Windows XP Professional
LAN	10/100/1000 Base Ethernet
PC Size	4U Chassis
Weight	Up to 50 Pounds



Digital Video Recorders

LPD Software

License Plate Detection Software

Latest technology to recognize and detect license plates

License Plate Detection Software (LPD) is one of the latest technologies that not only recognizes and counts vehicles, but distinguishes each as unique. It searches and compares this information against a stored database of license plates to find a match. License Plate Recognition is used for vehicular access control in parking lots, garages and for calculating related metric such as duration of stay, and frequency of visits. LPD software is an effective video security and parking monitoring solution that can enforce parking lot security or Highway Surveillance.

Features:

- Cutting edge license plate detection protocol
- Supports IP Cameras, USB Digital Cameras, Video Files, Image Files
- Records License Plate information
- Time Stamp Function with One-Click easy report function
- Search and View Specific License Plates
- High recognition rate and fast recognition time

Applications:

- Parking Lot Management
- Entrance Management
- Automatic Toll Collections Enforcement
- Traffic Enforcement Statistics
- Border Surveillance
- Stolen Vehicle Search
- Congestion Charge
- Gas Station Drive-off Prevention
- Surveillance System Integration

Traffic / License Plate Camera

Integration and Hierarchy

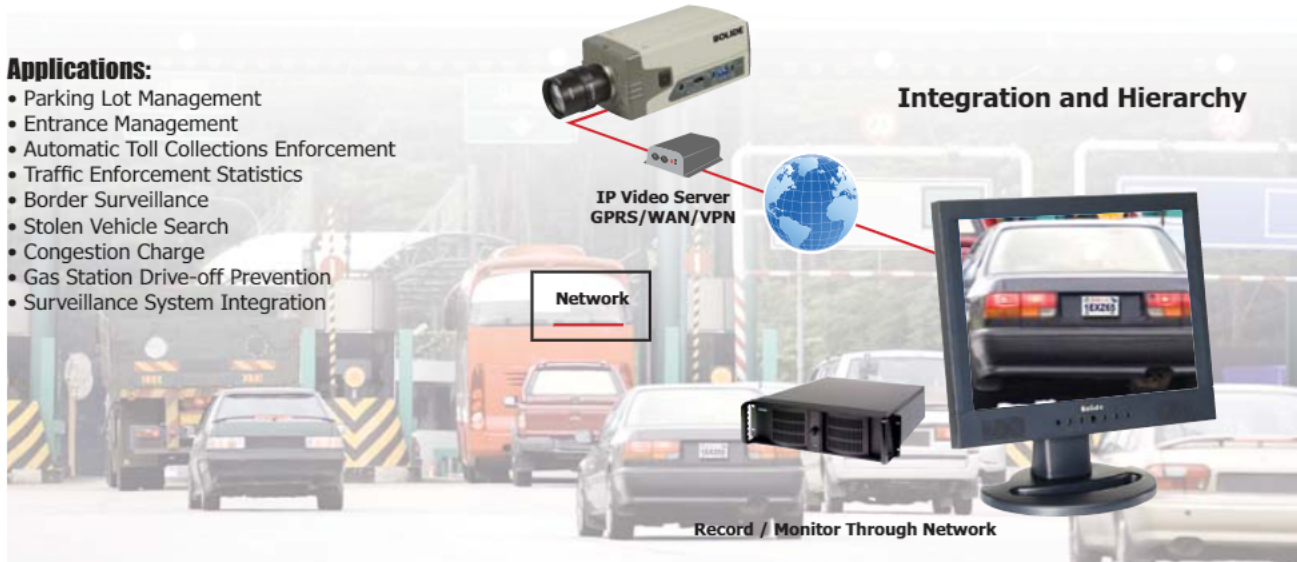

FDS Software

Face Detection & Search Software

Intelligent and Powerful Face Detection, Logging and Search solution

FDS (Face Detector & Search) software is a key tool for security professionals. Though video archiving solutions provide complete records of what happened at the scene, they do not allow for someone to quickly scan people present at the scene to shortlist, target, and identify potential miscreants. FDS can identify and capture human faces from still images, live video, and pre-recorded video clips. The images are saved along with the camera identification and a time stamp for later review. FDS can be deployed to improve security at government, commercial and industrial sites. With FDS, service establishments such as Banks, Casinos, Department Stores, Hotels and Restaurants can improve customer service and security.

Features:

- Detects, Recognizes and Records people's faces
- Identify & Verify people in the scene using a stored database of faces
- Automatic search and compare existing database
- Provides real-time alerts
- Can be deployed with Access Control Systems, at ATM Windows, Service and Ticketing Counters, Retail POS counters, doorways and more...



Security Monitors

CCTV Systems

Digital
Video Recorders

Security Monitors

CCTV Cameras

Observation Systems

Telephone &
Audio Devices

Covert Cameras

Parts &
Accessories

Video Wall

Bolide's LCD Video Wall implements multiple high speed video signal which unifies processing technology and replaces the insert card combination controller and solves the problem of the quantity limitation of video signal, VGA and DVI signal input. It can realize any multi-channel input and multi-combination. The LCD Video Wall combines all great technologies of the most excellent digital information displays, such as LCD display technology of high definition, high brightness and high color gamut, embedded hardware combination technology, multi-panel image processing technology and signal switch technology etc.

This product is fully customized & tailored for each application: City Safety controlling center, railway (subway), port and wharf monitoring system, intelligent traffic management controlling center, National Defense or Military monitoring system, power dispatching monitoring system, large scale mining monitoring system, financial management controlling center, TV Station or large scale broadcasting center, public areas or ad video wall in supermarket and live conference etc.



Video Wall

Multi Purpose Surveillance Video Display

Features:

- Customized Panel Design: 2x2, 3x3, 4x4 and more
- High Brightness
- High Contrast up to 1500:1
- Wide View Angle up to 170 degrees
- Designed for 24/7 security monitoring
- 120Hz Frequency Multiplication Refreshing Frequency
- More than 50,000 Hours of life-span of the LCD screen backlight
- Ultra Slim Edge Design
- Multiple display image signal source: BNC, VGA, S-Video etc.
- Any Combination of Display: Full Screen, Singles and Combination
- Superior Image Display Function: Image Cruise, Superposition, Drag etc.
- Universal Power Supply



Specifications:

Panel Size	19"	40"	46"
W/H Ratio	5:4	16:9	16:9
Brightness	450 cd/m ²	1000 cd/m ²	1000 cd/m ²
Resolution (per unit)	1280 x 1024	1366 x 768	1366 x 768
Contrast	1000:1	1500:1	1500:1
Definition (per unit)	1080i	1080p	1080p
Dimension (mm)	396(H)x324(W)	911.7(H)x524.2(W)	1047.4(H)x600.6(W)
Weight	2.3Kg	12.5Kg	18.5Kg
Color	16.7M	16.7M	16.7M
Viewing Angle	170° / 160°	178° / 178°	178° / 178°
Response Time	8ms	8ms	8ms
LCD Panel Number	Any Row (M) x Any Column (N)		
Edge within panels	18mm	20mm	20mm
Installing Method	Key-free Hanging Method		
Cabinet Width	≤ 180mm	≤ 200mm	≤ 200mm
Cabinet Material	Complete steel stand frame, solid wooden decoration frame		
Cabinet Size	Customized design: 2x2, 3x3, 4x4, 5x5, N x N		
Power Supply	100 ~ 230 (50/60Hz)		
Power (per unit)	35W	200W	200W
Operating Temp.	0°C ~ 60°C		
Operating Humidity	10 ~ 90%		
Input	BNC, VGA, S-Video (optional), DVI (optional)		
Video System	Worldwide Multiple Video System (NTSC/PAL)		

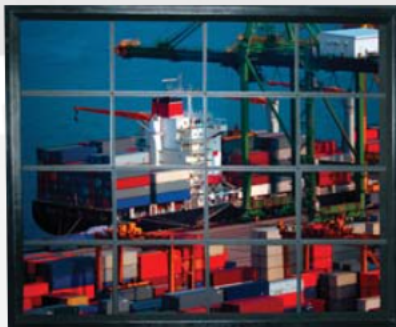

19" 4x4 Setup



40" 2x2 Setup



19" LCD Matrix Setup

Security Monitors

LCD Display

Bolide's LCD is a Flat Panel LCD monitor specifically designed for the security industry. It features 2CH BNC inputs with Looping, S-Video and VGA Output. It delivers more than 16 million colors and has a contrast ratio of 600:1. The LCD monitor also features fast 8ms response time and offers SXGA 1600x1200 resolution. With the easy OSD function, it allows you to change your preference easily. The Bolide LCD is all you need for the sharpest pictures in the industry.



BE8017LCD, BE8019LCD, BE8021LCD

Slim Design Security Grade LCD Monitor

Features:

- Up to SXGA 1600 x 1200 Resolution
- Fast Response Time Up to 12ms
- Viewing Angle 178°(H), 178°(V)
- Built-in 2 Channels BNC Input and Looping Out
- D-15 PC Connector, S-video Input and 3 x Audio Input

Specifications:

Model Number	BE8017LCD	BE8019LCD	BE8021LCD
Display Unit	4:3 TFT / LCD		
Video Input/Output	1x D-15 Input, 1 x S-video , 2 x BNC Input/Output		
Audio Input/Output	3 x Single Channel RCA Input /Output		
Panel Control	Menu (Brightness, Contrast, Saturation, Hue), Volume, Channel Switch		
Power Source	AC110V		
Power Consumption	Maximum: 32W		
Dimension(WxHxD)	383x335x70mm	458x372x84mm	463x380x84mm
Weight	5.0kg	5.5kg	5.6kg
Definition	660TVL	1000TVL	1000TVL
Video System	Worldwide Multiple Video System (NTSC/PAL)		
Max Resolution	UXGA 1280x1024	UXGA 1280x1024	UXGA 1600x1200
Audio Power	Max. 1.0W		
Maximum Brightness	Enhanced 450cd/m		
Maximum Contrast	600:1	700:1	700:1
Response Time	12ms	8ms	16ms
Visual Angle	170°, 150°	160°, 135°	178°, 178°



CCTV Systems

Digital Video Recorders

Security Monitors

CCTV Cameras

Observation Systems

Telephone & Audio Devices

Covert Cameras

Parts & Accessories

LCD Display

BE8017LCD/Lite, BE8019LCD/Lite

LITE Series Security Grade LCD Monitor

The Bolide Security LCD LITE series provides outstanding color and clarity. Our High Resolution LCD monitors are a perfect choice for the most sophisticated security, surveillance and monitoring operations. With the latest LCD technology, the LCDs have a contrast ratio of 800:1, delivers the sharpest and brightest video pictures. Bolide's LCD Lite series also features super fast 5ms response time and SXGA1280x1024 resolution. With the OSD function, you will be able to change your preference easily. Bolide Security LCD LITE series is the perfect choice for your surveillance needs.

Features:

- SXGA 1280x1024 Resolution
- Fast Response Time 5ms
- Viewing Angle 160°(H),160°(V)
- Built-in BNC Input and Looping Out

Specifications:

Model No.	BE8017LCD-Lite	BE8019LCD-Lite
Display Unit	4:3 TFT/LCD	
Video In/Output	1xD-15 Input, 1xS-video, BNC Input/Output	
Audio Input/Output	RCA Input/Output	
Panel Control	Menu, Volume, Channel Switch	
Power Source	AC110V	
Power Consumption	Maximum: 32W	
Definition	660TVL	
Video System	Worldwide Multiple Video System (NTSC/PAL)	
Resolution	1280x1024 SXGA	
Audio Power	Max. 1.0W	
Maximum Brightness	Enhanced 300cd/m ²	
Maximum Contrast	800:1	
Response Time	5 ms	
Visual Angle	160°, 160°	



CRT Display

BE8043/2

14" High Resolution Color Monitor

Features:

- 0.56MM Strip Pitch
- Resolution: 420 TV Lines
- Two Channel Video Worldwide Multiple System: NTSC & PAL
- Universal Voltage: 90-250V / BNC Interface In/Output

Specifications:

Teletron	14 Inches
Video In/Output	BNC Interface
Control Mode	Contrast, Brightness, Color Saturation, Tint
Power Source	90 ~ 250V
Resolution	420 TV Lines Resolution
Video System	NTSC, PAL
Convergence	Maximum 0.4mm
Operating Temp.	32°F ~ 122°F
Operating Humidity	10% ~ 90%
Dimension	367 x 342 x 392mm



CCTV Cameras

Board Cameras

KPC-400

B/W Spy Camera with Case

Specifications:

Image Sensor	1/3" B/W CCD
Effective Pixels	512H x 492V
Scanning System	525 Lines 2:1 interlaced
Resolution	420 TV Lines Resolution
Shutter Speed	1/60 ~ 1/100,000
S/N Ratio	more than 48dB
Sync. System	Internal
Min. Illumination	0.05 lux
White Balance	Automatic
Power Supply	12VDC
Power Consumption	120mA or less
Audio Output	RCA

KPC-600

Color Spy Camera with Case

Specifications:

Image Sensor	1/3" Color CCD
Effective Pixels	512H x 492V
Scanning System	525 Lines 2:1 interlaced
Resolution	420~450 TV Lines Resolution
Shutter Speed	1/60 ~ 1/100,000
S/N Ratio	more than 48dB
Sync. System	Internal
Min. Illumination	0.5 lux
White Balance	Automatic
Power Supply	12VDC
Power Consumption	120mA or less
Audio Output	RCA

KPC-600WD

Color Pinhole Wide Dynamic Range Board Camera

Specifications:

Image Sensor	1/3" Digital Pixel System
Effective Pixel	720(H) x 540(V)
Scanning System	525 Lines 2:1 interlaced
Resolution	550 TV Lines Resolution
Shutter Speed	1/60 ~ 1/100,000
S/N Ratio	more than 50dB
Sync. System	Internal
Min. Illumination	0.08 lux (Day & Night)
White Balance	AWB/ATW/Manual Selectable
Lens	3.7mm Pinhole
Power	12VDC, > 250mA
Control Method	OSD Control



Features:

- Micro Compact design
- 420 Lines of Resolution
- Low light performance
- Plug and play cables
- Mini mounting bracket included
- Dimensions: 30mm x 30mm
- Pinhole Board Lens: 3.6mm



Features:

- Micro Compact design
- 420~450 TV Lines Resolution
- Built-in microphone for audio monitoring
- Plug and play cables
- Mini mounting bracket included
- Dimensions: 36mm x 36mm
- Pinhole Board Lens: 3.6mm



Features:

- Pixim DPS (Digital Pixel System)
- 550 TV Lines Resolution
- Widest Dynamic Range (120dB max)
- 0.08 Lux Sensitivity (Day & Night)
- Advance & Compact design
- Standard Pinhole Lens: 3.7mm
- Ideal for ATM's, Government facilities and more

CCTV Systems

Digital Video Recorders

Security Monitors

CCTV Cameras

Observation Systems

Telephone & Audio Devices

Covert Cameras

Parts & Accessories

Board Cameras

BC2003 / BC2003HDN

Micro High Resolution Pinhole Board Camera

Specifications:

Model Number	BC2003	BC2003HDN
Image Sensor	1/3" Color CCD	1/3" Day & Night CCD
Effective Pixels	512H x 492V	
Scanning System	525 Lines 2:1 interlaced	
Resolution	420 TVL	450 TVL
Shutter Speed	1/60 ~ 1/100,000	
S/N Ratio	> 45dB	
Sync. System	Internal	
Min. Illumination	0.05 Lux	0.002 Lux
Power Supply	9VDC ~ 14VDC, 100mA or less	
Operating Temperature	32° ~ 122°F	
Operating Humidity	90% RH Max	



Features:

- 1/3" CCD Color, Day & Night (BC2003HDN)
- Long Life and Reliability
- High resolution 420~450 TVL Resolution
- up to 0.002 Lux (Mono, Day & Night)
- Ultra Compact Design
- Dimensions: 31mm x 31mm

Bullet Cameras

BC1034

Color Pinhole Bullet Camera

Specifications:

Image Sensor	1/3" Sony Super HAD CCD
Effective Pixels	510H x 492V (250k pixels)
Scanning System	525 Lines 2:1 interlace
Resolution	420 TV Lines Resolution
Shutter Speed	1/60 ~ 1/100,000 sec
S/N Ratio	> 48dB
Sync. System	Internal
Min. Illumination	0.2 lux / F1.2
Video Out	1.0 Vp-p (75ohm)
Power Supply	12VDC
Power Consumption	110mA or less
Dimension	70 x 23mm



Features:

- 1/3" Sony Super HAD CCD
- Color: 420 TV Lines Resolution, 0.2 Lux
- Pinhole camera
- Shutter Speed: 1/60 ~ 1/100,000 sec
- Power Consumption: 110mA
- Operating Temp: 14°F ~ 122°F



BC3034H

High Resolution Color Day and Night Pinhole Bullet Camera

Specifications:

Image Sensor	1/3" Sony High Resolution CCD
Effective Pixels	510(H) x 492(V)
Resolution	550 TV Lines Resolution
Min. Illumination	0.05 lux/F1.2
S/N Ratio	> 48dB
Shutter Speed	1/60 ~ 1/100,000 sec
A.G.C.	On/Off
Day/Night	Yes
B.L.C.	On/Off
Day & Night Function	Built-in
Video Out	BNC, 1.0Vp-p (75ohm)
Power Consumption	150mA or less



Features:

- 1/3" Sony CCD
- 550 TV Lines of Resolution
- BLC & AGC Control
- Excellent Color Reproduction
- Remarkable Sensitivity / Auto White Balance
- Day & Night Function



Bullet Cameras

BC2033H

Weather Proof Miniature High Resolution Color Bullet Camera

Features:

- 420 TV Lines Resolution, 0.2 Lux
- Operating Temp: 14°F ~ 122°F
- 1/4" Sony Super HAD CCD
- S/N Ratio: > 45dB
- Aluminum Weatherproof Housing
- Shutter Speed: 1/60 ~ 1/100,000 sec

Specifications:

Model No.	BC2033H
Image Sensor	1/3" Sony Super HAD CCD
Effective Pixels	510H x 492V
Scanning System	525 Lines 2:1 interlace
Resolution	420 Lines
Shutter Speed	1/60 ~ 1/100,000
S/N Ratio	> 48dB
Sync. System	Internal
Min. Illumination	0.2 Lux
Power Supply	12VDC
Power Consumption	110mA or less
Dimension	70 x 23mm



BE1025/100IR

Vari-Focal Color DSP CCD Outdoor IR Camera w/ Mechanical IR Cut

Features:

- IP66 Rated Weatherproof Housing
- 1/3" Sony Super HAD CCD
- 500 TV Lines Resolution
- Built-in infrared up to 100 FT
- 4.0mm ~ 9.0mm Vari-Focal lens
- Dual Voltage 12VDC~24VAC

Specifications:

Image Sensor	1/3" Sony Super HAD CCD
Effective Pixels	510H x 492V
Scanning System	2:1 interlace
Resolution	500 TV Lines Resolution
Shutter Speed	1/60 ~ 1/100,000 sec
S/N Ratio	>48dB
Sync. System	Internal
Infrared LEDs	28 (850nm LEDs)
IR Range	Up to 100ft
BLC	On/Off Switchable
Water Resistant	IP66
Construction	Aluminum with silver baked
Power Supply	12VDC/24VAC



CCTV Systems

Digital Video Recorders

Security Monitors

CCTV Cameras

Observation Systems

Telephone & Audio Devices

Covert Cameras

Parts & Accessories

Bullet Cameras

BE1025-AIR

4-9mm Focus Free Vari-Focal Auto Iris Infrared Bullet Camera

Features:

- 1/3" Sony Super HAD CCD
- 520 TVL, 0 Lux
- 4.0-9.0mm Vari Focal w/ Motorized Auto Focus
- Built-in RS 485 for zoom in/out operation
- 36 High Power IR Leds, Up to 100ft

Specifications:

Image Sensor	1/3" Sony Super HAD CCD
Effective Pixels	510H x 492V
Resolution	520TV Lines
Lens	4.0 ~ 9.0mm Auto Focus
Sync. System	Internal
S/N Ratio	more than 48dB
Min. Illumination	0 lux
Electronic Shutter Speed	1/60 ~ 1/100,000
White Balance	Auto
A.G.C.	Auto
Power Supply	12VDC
Construction	Aluminum with silver baked



Works Best with
Bolide CCTV Tester

BC2002/HQDNVLIR

Outdoor Anti-Head Light License Plate Infrared Bullet Camera

Features:

- 1/3" Sony Super HAD CCD
- Sony HQ1, 540 TVL, 0 Lux
- 6 Pcs Super High Power Reflection LEDs + 24 IR LEDs
- Anti-Head Light Technology for night operation
- External Varifocal Lens Adjustment
- User Friendly DC Level & High Power IR LEDs Adjustments
- 3-axis Adjustable & Cable Management Bracket
- Built-in DNR & Sense Up Functions

Specifications:

Image Sensor	1/3" Sony Super HAD CCD
Effective Pixels	795H x 596V
Scanning System	525 Lines 2:1 interlace
Resolution	540 TVL
Shutter Speed	1/60 ~ 1/100,000
S/N Ratio	more than 50dB
Sync. System	Internal
Min. Illumination	0 Lux (IR On)
IR Range	Outdoor 100ft / Indoor 150ft, 30 units
Water Resistant	IP66
Lens	Aspherical 3.8mm ~ 9.5mm
DNR; Sense Up	Automatic
Power Supply	12VDC, 90%RH
Dimension	93Ø x 163mm



Vari-Focal Adjustment



License Plate Camera with
Anti Head Light Technology

CCTV Cameras

Bullet Cameras

BC3035H

3-Axis In/Outdoor Color DSP CCD IR Camera

Specifications:

Image Sensor	1/4" Sony Super HAD CCD
Effective Pixels	510H x 492V
Scanning System	2:1 interlace
Resolution	520 TV Lines Resolution
Shutter Speed	1/60 ~ 1/100,000 sec
S/N Ratio	>48dB
Sync. System	Internal
Infrared LEDs	36 (850nm LEDs)
IR Range	Up to 100ft
Gamma	0.45
Construction	Aluminum
Power Supply	12VDC



Covert Cable Design for Maximum Protection

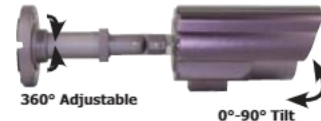

Features:

- Weatherproof Housing
- 1/4" Sony Super HAD CCD
- 520 TV Lines Resolution
- Built-in infrared up to 100 FT
- True 3-Axis for Extreme Positioning
- 36pcs 850nm LEDs for night operation

BC6035H

3-Axis In/Outdoor Weatherproof Infrared Bullet Camera

Specifications:

Image Sensor	1/3" Sony HAD CCD
Effective Pixels	768H x 494V
Scanning System	525 Lines 2:1 interlace
Resolution	480 TVL
Shutter Speed	1/60 ~ 1/100,000
S/N Ratio	more than 48dB
Sync. System	Internal
Min. Illumination	0 Lux (IR On)
Power Supply	12VDC
IR Range	75ft, 23 Leds
Lens	3.6mm



Features:

- 1/3" Sony Super HAD CCD
- 480 Lines of Resolution, 0 lux
- Auto Gain Control
- 23 High Power IR Leds, Up to 75ft

BC6036HVA/12/24

3-Axis In/Outdoor 4-9.0mm Vari-Focal Infrared Bullet Camera

Specifications:

Image Sensor	1/3" Sony Super HAD CCD
Effective Pixels	510H x 492V
Resolution	520TV Lines
Lens	4.0 ~ 9.0mm Manual Focus
Sync. System	Internal
S/N Ratio	more than 48dB
Min. Illumination	0 lux
Electronic Shutter Speed	1/60 ~ 1/100,000
White Balance	Auto
IR Range	36 IR Leds, 100ft
Power Supply	12VDC / 24VAC
Construction	Aluminum



Features:

- 1/3" Sony Super HAD CCD
- 520 Lines of Resolution, 0 lux
- Auto Gain Control
- 36 High Powered IR Leds, Up to 100ft

Dome Cameras

BC1009

Color Dome Camera

Specifications:

Image Sensor	1/3" Sony CCD
Effective Pixels	510H x 492V(250k Pixels)
Scanning System	525 Lines 2:1 interlace
Signal System	60Hz
Resolution	420 ~ 450 TV Lines
Shutter Speed	1/60 ~ 1/100,000
S/N Ratio	> 48dB
Sync. System	Internal
Video Output	1.0 Vp-p (75ohm)
Min. Illumination	0.5 Lux
Power Supply	12VDC
Power Consumption	120mA or Less
Dimension	100 x 65(L)mm



Features:

- 1/3" Interline Transfer CCD
- Color: 420-450 TV Lines Resolution, 0.5 Lux
- S/N Ratio: > 45dB
- Shutter Speed: 1/60 ~ 1/100,000 sec.
- Standard Lens: 3.6mm (Optional 3.6mm,6mm,8mm,12mm)



BC1009IR

Color Infrared Dome Camera

Specifications:

Image Sensor	1/4" Sony CCD
Effective Pixels	510H x 492V(250k Pixels)
Scanning System	525 Lines 2:1 interlace
Resolution	420 ~ 450 TV Lines Resolution
Shutter Speed	1/60 ~ 1/100,000
S/N Ratio	> 48dB
Sync. System	Internal
Min. Illumination	0 Lux
Video Output	1.0 Vp-p (75ohm)
IR Range	12LEDs, 45FT
Power Supply	12VDC
Power Consumption	180mA or Less



Features:

- Built-in Infrared 12 LEDs
- High Resolution Sony CCD
- 420-450 TV Lines Resolution, 0 Lux
- IR Range: 45 FT.
- Impact Resistant Shell



BC1009HVA

High Resolution Vari-Focal Dome Camera

Specifications:

Image Sensor	1/3" Sony Ex-view CCD
Effective Pixels	510H x 492V(250k Pixels)
Scanning System	525 Lines 2:1 interlace
Resolution	520 TV Lines Resolution
Shutter Speed	1/60 ~ 1/100,000
S/N Ratio	> 45dB
Sync. System	Internal
Min. Illumination	0.05 Lux
Video Output	1.0 Vp-p (75ohm)
Vari-Focal	4 - 9.0mm
Power Supply	12VDC
Power Consumption	180mA or Less



Features:

- Built-in Vari-Focal
- High Resolution Ex-view Sony CCD
- 520 TV Lines Resolution, 0.05 Lux
- Impact Resistant Shell



CCTV Cameras

Dome Cameras

BC3009HDN/12/24

High Resolution Day & Night Dual Voltage Dome Camera

Features:

- 1/3" Sony High Resolution Color CCD
- 550 TV Lines Resolution
- 0.05 lux
- Standard 3.6mm Lens
- Excellent color reproduction
- Remarkable sensitivity
- AWB / BLC / AGC control

**Specifications:**

Image Sensor	1/3" Sony High Resolution CCD
Effective Pixels	768H x 494V
Scanning System	525 Lines 2:1 interlace
Resolution	550 TV Lines Resolution
Light Sensitivity	0.05 lux
Shutter Speed	1/60 ~ 1/100,000 sec
S/N Ratio	>48dB
Sync. System	Internal
Standard Lens	3.6 mm
Power Supply	12VDC/24VAC
Power Consumption	150mA or Less



BC3009HDNVA/12/24 (Black or White)

High Resolution Day & Night Vari-Focal Auto Iris Dome Camera

Features:

- 1/3" Sony High Resolution Color CCD
- 550 Lines of Resolution
- 0.05 lux
- Vari-Focal Lens 4mm ~ 9mm
- Available in two colors White or Black
- Excellent color reproduction
- Remarkable sensitivity
- AWB / BLC / AGC control

**Specifications:**

Image Sensor	1/3" Sony High Resolution CCD
Effective Pixels	768H x 494V
Scanning System	525 Lines 2:1 interlace
Resolution	550 TV Lines
Min. Illumination	0.05 lux
Shutter Speed	1/60 ~ 1/100,000 sec
S/N Ratio	>48dB
Sync. System	Internal
Vari-Focal Lens	4.0~9.0mm
Power Supply	12VDC/24VAC
Power Consumption	150mA or Less



CCTV Systems

Digital
Video Recorders

Security Monitors

CCTV Cameras

Observation Systems

Telephone &
Audio Devices

Covert Cameras

Parts &
Accessories

Dome Cameras

BC1009AVAIR

Outdoor Infrared Armored Dome Camera

Specifications:

Image Sensor	1/3" Sony HQ1 Color CCD
Effective Pixels	768H x 494V
Scanning System	2:1 interlace
Resolution	520 TV Lines Resolution
Shutter Speed	1/60 ~ 1/100,000 Sec
S/N Ratio	50dB or More (AGC Off)
Sync. System	Internal
Min. Illumination	0.2 Lux, 0 Lux IR On
Day & Night	Yes
Video Output	1.0Vp-p (Sync. Negative)
Gamma Characteristic	0.45
Consumption Current	200mA (LED Off), 600mA (LED On)
Power Supply	12VDC
Vari-Focal	4~9mm Lens Auto Iris
Operation Temperature	-10°C ~ 50°C



Features:

- 1/3" Sony HQ1 Color CCD
- 520 TV Lines Resolution
- 21 LEDs, 0 Lux, up to 65ft
- Varifocal Lens: 4~9mm with Auto Iris
- Polycarbonate Vandal & IP66 Weather Proof
- 3 Axis Mounting

BC1009AVA

Vandal Proof Day & Night Dome Camera with Vari-Focal and Auto Iris

Specifications:

Image Sensor	1/3" Super HAD CCD
Effective Pixels	768H x 494V
Scanning System	525 Lines 2:1 interlace
Resolution	480 TV Lines Resolution
Shutter Speed	1/60 ~ 1/100,000 Sec
S/N Ratio	>48dB
Sync. System	Internal
Min. Illumination	0.01 Lux
Day & Night	Yes
Power Supply	12VDC
Vari-Focal	3.8~8.0mm
Dimension	140 x 80(L)mm



Features:

- 1/3" Sony Super HAD Day & Night CCD
- Up to 480 TV Lines Resolution, 0.01 Lux
- Varifocal Lens: f3.8mm-8mm
- Manual Focus & DC auto iris lens
- Aluminum Diecast: IP67 Rated Vandal Proof Shell
- Dual Mounting: Surface / Ceiling & Wall

BC3009AVA

Vandal Proof Day & Night Dome Camera

Specifications:

Image Sensor	1/3" Sony CCD
Effective Pixels	510H x 492V
Scanning System	525 Lines 2:1 interlace
Resolution	520 TV Lines Resolution
Shutter Speed	1/60 ~ 1/100,000
S/N Ratio	>48dB
Sync. System	Internal
Min. Illumination	0.05 Lux
Day & Night	Yes
Power Supply	12VDC/24VAC
Housing	IP67 Weather Resistant Vandal Proof Shell
Dimension	142 x 85(L)mm



Features:

- 1/3" Sony CCD
- IP67 Weather Resistant Shell
- Up to 520 TV Lines Resolution
- Minimum Illumination 0.05 lux
- Vandal Proof Housing
- Built-in Vari-Focal Lens 4~9.0mm
- Auto Iris and BLC
- Optional wall mount bracket

CCTV Cameras

Dome Cameras

BC2009-AVAIRF

4-9mm Focus Free Vari-Focal Auto Iris Infrared Bullet Camera

Features:

- 1/3" Sony Super HAD CCD
- 500 TVL, 0 Lux
- 4.0-9.0mm Vari Focal w/ Motorized Auto Focus
- Built-in RS-485 for zoom in/out operation

Specifications:

Image Sensor	1/3" Sony Super HAD CCD
Effective Pixels	510H x 492V
Resolution	500TV Lines
Lens	4.0 ~ 9.0mm Auto Focus
Sync. System	Internal
S/N Ratio	more than 48dB
Min. Illumination	0 lux
Electronic Shutter Speed	1/60 ~ 1/100,000
White Balance	Auto
A.G.C.	Auto
Power Supply	12VDC
Construction	Aluminum

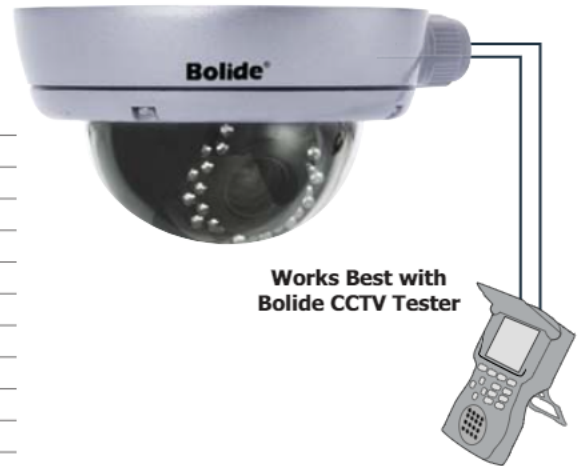

BC1009AVAWD

Vandal Proof Wide Dynamic Range Dome Camera

The all-new WDR dome camera is a high resolution, high performance color dome surveillance camera. Its housing is vandal proof and has a polycarbonate dome that withstands high impacts. With Wide Dynamic Range, this camera delivers excellent images under strong backlit lighting conditions. It has Day/ Night function and a low light function to render clear images 24 hours a day.

Features:

- 1/3" DPS (Digital Pixel System)
- 550 TVL, 0.08 Lux
- Wide Dynamic Range function
- Day/Night function
- On-screen menus for camera settings



Specifications:

Image Sensor	1/3" DPS (Digital Pixel System)
Effective Pixels	720H x 540V
Scanning System	525 Lines 2:1 interlace
Resolution	550 TV Lines Resolution
Shutter Speed	1/60 ~ 1/100,000 sec
S/N Ratio	> 50dB
Sync. System	Internal
Min. Illumination	0.08 Lux/F1.2
Day & Night Function	On/Off
Wide Dynamic Range	On/Off
White Balance	Auto 2000K to 11,000K
Flickerless	On/Off
Shutter	Electronic/Manual/Digital
Power Supply	12VDC/500mA
Power Consumption	280mA or Less

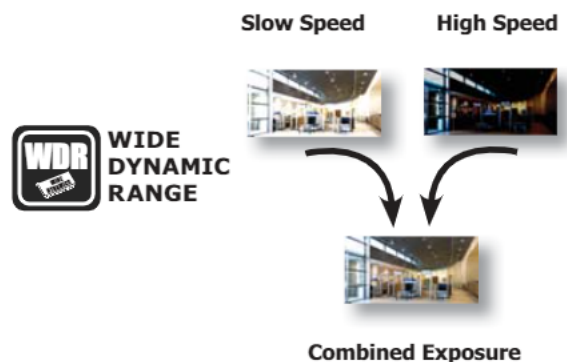

CCTV Systems

Digital Video Recorders

Security Monitors

CCTV Cameras

Observation Systems

Telephone & Audio Devices

Covert Cameras

Parts & Accessories

Dome Cameras

BN5009M

Advanced Professional WAN/LAN Mega Pixel Camera

Specifications:

Image Sensor	Exview 1.3Mega Pixel
Effective Pixels	1280 x 960
Sync. System	Internal
Stream Range	10kb - 4M
Min. Illumination	0.2 Lux / F1.2
White Balance	AWB/ATW/DESAT/EXTEND
Compression	H.264
Max Video Resolution	1280x960, 22.5FPS
Ethernet	10/100 Base-T, RJ45
Security	Password Protection
Built-in recording	Mini SD
Audio Compression	G723.1/6.3kbps, Two way audio
Web Browser	IE 5.5 or higher
Power Consumption	12VDC, 1A



*Picture may vary from the actual item

Features:

- Mega Pixel video quality - live and recorded.
- Multi-level password for maximum protection
- IP address filtering and HTTPS encryption
- Integrates both Network IP camera and DVR/NVR functions
- Powerful event and alarm management
- View real-time and playback history on both Intranet and Internet
- Powerful management tools for remote configuration and status

BC5009WD

WDR Wide Dynamic Range Color Dome Camera

Specifications:

Image Device	Digital Pixel System
Resolution	550 TV Lines
Dynamic Range	120dB Maximum
SYNC System	Internal
Scanning System	2:1 Interface
Min. Illumination	0.08 lux
White Balance	AWB/ATW/Manual Selectable
AWB Range	Auto 2000K to 11,000K
Power Supply	12VDC
Power Consumption	<4W (Max)
Operation Temperature	14°F ~ 113°F, RH95%



Features:

- Pixim DPS (Digital Pixel System)
- 550 Lines of Resolution
- On screen display
- 0.08 lux sensitivity (Day & Night)
- Wide Dynamic Range 120dB
- Adjustable auto gain control

BC5009HVAWD

WDR Wide Dynamic Range Vari-Focal Color Dome Camera

Specifications:

Image Device	Digital Pixel System
Resolution	550 TV Lines
Dynamic Range	120dB Maximum
SYNC System	Internal
Scanning System	2:1 Interface
Min. Illumination	0.08 lux
White Balance	AWB/ATW/Manual Selectable
AWB Range	Auto 2000K to 11,000K
Power Supply	12VDC
Power Consumption	<4W (Max)
Lens	4.0 - 9.0mm
Operation Temperature	14°F ~ 113°F, RH95%



Features:

- Pixim DPS (Digital Pixel System)
- 550 Lines of Resolution
- On screen display
- 0.08 lux sensitivity (Day & Night)
- 4.0 - 9.0mm Vari-Focal
- Adjustable auto gain control

CCTV Cameras

Dome Cameras

BC3009AIR

3 Axis Armored In/Outdoor Infrared Dome Camera

Features:

- 1/3" Sony Color CCD
- 520 Lines of Resolution, 0 lux
- Vandal Proof Shell, IP66 Weather Proof Housing
- IR Range: up to 60ft

Specifications:

Image Sensor	1/3" Sony CCD
Effective Pixels	510H x 492V(250k Pixels)
Scanning System	525 Lines 2:1 interlace
Resolution	520 TV Lines Resolution
Shutter Speed	1/60 ~ 1/100,000 sec.
S/N Ratio	>48dB
Sync. System	Internal
Min. Illumination	0 Lux
IR Range	23LEDs, 60ft
Power Supply	12VDC



BC1009IRAD

Weather-Proof IR Color Armor Dome Camera

Specifications:

Image Sensor	1/3" Sony Super HAD CCD
Effective Pixels	510H x 492V(250k Pixels)
Scanning System	525 Lines 2:1 interlace
Resolution	450 TV Lines Resolution
Shutter Speed	1/60 ~ 1/100,000 sec.
S/N Ratio	>48dB
Sync. System	Internal
Min. Illumination	0 Lux
IR Range	23LEDs, 60ft
Power Supply	12VDC
Power Consumption	150mA or Less



Features:

- 1/3" Sony Color CCD
- 450 Lines of Resolution
- 0 lux
- Vandal Proof Shell, IP66 Weather Proof Housing
- IR Range: up to 50ft

BC3009-IRODVA

Outdoor Vari Focal Armor IR Dome Camera

Specifications:

Image Sensor	1/3" Sony High Resolution CCD
Resolution	550 TVL
IR LEDs	36 IR LEDs (850nm)
IR Range	115ft - 145ft
Shutter Speed	1/60 ~ 1/100,000sev
S/N Ratio	>48dB
White Balance	Auto
BLC	Auto
Lens	3.5 - 8.0mm
Power Supply	12VDC
Power Consumption	400mA
Housing	IP55 Water Resistant Shell



Features:

- 1/3" Sony High Res. CCD
- 550 TV lines of resolution, 0 lux
- Built-in 3.5-8mm vari-focal lens (External adjustable Zoom and Focus)
- 36pcs IR LED
- IR range 115ft - 145ft
- Weatherproof housing with IP55 Standard



Dome Cameras

BC3009-IRODVA/2.8-11

Outdoor 2.8-11mm Vari Focal Armor IR Dome Camera

Specifications:

Image Sensor	1/3" Sony High Resolution CCD
Resolution	550 TVL
IR LEDs	36 IR LEDs (850nm)
IR Range	115ft - 145ft
Shutter Speed	1/60 ~ 1/100,000sev
S/N Ratio	>48dB
White Balance	Auto
BLC	Auto
Lens	2.8 - 11.0mm
Power Supply	12VDC
Power Consumption	400mA
Housing	IP55 Water Resistant Shell



Features:

- 1/3" Sony High Res. CCD
- 550 TV lines of resolution, 0 lux
- Built-in 2.8-11mm vari-focal lens (External adjustable Zoom and Focus)
- 36pcs IR LED
- IR range 115ft - 145ft
- Weatherproof housing with IP55 Standard



BC2009HG

3 Axis Adjustable Gimble Dome Camera

Specifications:

Image Sensor	1/4" Sony CCD
Effective Pixels	510H x 492V(250k Pixels)
Scanning System	525 Lines 2:1 interlace
Resolution	420 ~ 450 TV Lines Resolution
Shutter Speed	1/60 ~ 1/100,000 sec.
S/N Ratio	>48dB
Sync. System	Internal
Video Output	1.0Vp-p (75ohm)
Min. Illumination	0.2 Lux
Power Supply	12VDC
Power Consumption	120mA or Less
Dimension	106 x 79(L)mm
Power Supply	12VDC
Operation Temperature	-10°C ~ 50°C



Features:

- 1/4" SONY Color CCD
- High resolution: 420-450 TVL
- 12VDC
- Backlight compensation
- Automatic gain control
- Using the unique 3 axis gimble



BC2009 Miniature Series

Miniature Dome Camera with Mounting Bracket Option

Specifications:

Image Sensor	1/4" Sony CCD
Effective Pixels	510H x 492V
Scanning System	525 Lines 2:1 interlace
Resolution	420 ~ 450 TV Lines Resolution
Shutter Speed	1/60 ~ 1/100,000 sec.
S/N Ratio	>48dB
Sync. System	Internal
Video Output	1.0 Vp-p (75ohm)
Min. Illumination	0.5 lux
Power Supply	12VDC
Power Consumption	120mA or less
Dimension	90~95 x 80(L)mm



BC2009/WM1



BC2009/WM2



BC2009/WMB



BC2009/CM

Features:

- Impact Resistant Shell
- Features 1/4" Sony CCD
- 420~450 Lines of resolution
- 0.5 lux light sensitivity
- Various mounting options
- Plug and Play, easy for operation



CCTV Cameras

Box Cameras

BB1001/12/24, BC2002/12/24

Advanced Dual Voltage Professional Box Camera

Specifications:

Model Number	BB1001/12/24	BC2002/12/24
Image Sensor	1/3" CCD	1/4" Sony CCD
Effective Pixels	510H x 492V	
Scanning System	525 Lines 2:1 Interface	
Resolution	420 TV Lines Resolution	
Shutter Speed	1/60~1/100,000 sec	
S/N Ratio	> 48dB	
Sync System	Internal	
Min. Illumination	0.2 lux	1.0 lux
Video Output	1.0 Vp-p(75ohm)	
Auto Gain Control	On/Off Optional	
Electronic Shutter Control	EE/AI Switchable	
Power Supply	12VDC / 24VAC	



Features:

- Built-in Line Lock
- Dual voltage: 12VDC or 24VAC
- Video Output: 1.0Vp-p, 75 ohm BNC
- Back Light Compensation: On/Off Optional
- Shutter Speed: 1/60 ~ 1/100,000 sec
- C/CS Mount

BC2002HDN/12/24

High Resolution Day & Night Color Professional CCD Camera

Specifications:

Image Sensor	1/3" Sony Super HAD CCD
Effective Pixels	768H x 494V
Scanning System	2:1 Interface
Resolution	480 TV Lines Resolution
Shutter Speed	1/60~1/100,000 sec
S/N Ratio	> 48dB (AGC OFF)
Sync System	Internal
Min. Illumination	0.5 lux/F1.2
Gamma	0.45
White Balance	Auto Tracking
AGC / BLC	On / Off
Power Supply	12VDC / 24VAC, 2.8W



Features:

- 1/3" Color Sony Day & Night CCD (Super HAD)
- Up to 480 TV Lines Resolution, 1.0 Lux Color & 0.5 Lux Mono
- Back Light Compensation: On/Off Optional
- Shutter Speed: 1/60 ~ 1/100,000 sec
- Video Output: 1.0Vp-p (75ohm) BNC
- S/N Ratio: > 48dB
- Day & Night Function

BC2002EXVIR

Professional High Resolution Exview Color DSP CCD Infrared Camera

Specifications:

Image Sensor	1/3" Sony Extra View CCD
Effective Pixels	811(H) x 508(V)
Resolution	500 TV Lines Resolution
Shutter Speed	1/60 ~ 1/100,000
S/N Ratio	> 52dB
Sync. System	Internal
Min. Illumination	0 lux IR on, 0.01 lux/F1.2
White Balance	ATW/AWB Switchable, 0 Color Rolling
Mirror Function	On/Off
IR Range	4 LEDs 840nm, 50 FT
Digital Zoom	2x
Gamma	0.45
Power Supply	12VDC/24VAC
Dimensions	58(W) x 52(H) x 98(D)mm



Features:

- 1/3" Color Sony Extra View CCD
- Up to 500 TV Lines Resolution, 0.01 Lux at F1.2
- Shutter Speed: 1/60 ~ 1/100,000 sec
- Built-in Infrared (50ft)
- Zero Color Rolling, Mirror Function, Super Low Smear

Box Cameras

BC2002HQDN/12/24

Sony HQ High Resolution Box Camera

Features:

- 1/3" Sony Super HAD CCD
- 540 TVL, 0.14 Lux
- DSP: Sony HQ1
- Automatic Day & Night Function
- Dual Voltage 12VDC / 24VAC
- BLC, AGC and Flickerless control

Specifications:

Image Sensor	1/3" Sony Super HAD CCD
DSP	Sony HQ1
Effective Pixels	811H x 508V
Scanning System	2:1 Interface
Resolution	540 TV Lines Resolution
Shutter Speed	1/60~1/100,000 sec
S/N Ratio	> 50dB (AGC OFF)
Sync System	Internal
Min. Illumination	0.14 lux / F1.0
A.G.C. / B.L.C	On / Off
Flickerless	On / Off
Auto White Balance	AWB
Power Supply	12VDC / 24VAC
Power Consumption	2.0W
Dimensions	60(W) x 50(H) x 100(L)mm



BC2002HQDNC

High Resolution Box Camera with Mechanical IR Cut Filter

Features:

- 1/3" Sony Super HAD CCD
- 540 TVL, 0.15 Lux, DSP: Sony HQ1
- Automatic Day & Night Function
- Dual Voltage 12VDC / 24VAC
- Mechanical IR Cut Filter

Specifications:

Image Sensor	1/3" Sony Super HAD CCD
DSP	Sony HQ1
Effective Pixels	811H x 508V
Scanning System	2:1 Interface
Resolution	540 TVL
IR Sensitivity	700 ~ 1100nm
S/N Ratio	> 50dB (AGC OFF)
Sync System	Internal
Min. Illumination	0.15 lux / F1.0
Day / Night Switching	Mechanical IR Cut Filter Auto Switching
B.L.C.	On / Off
A.G.C.	On / Off
Video Output	1Vp-p Composite
Power Consumption	3.0W
Power Supply	12VDC / 24VAC
Operation Environment	- 10°C ~ 50°C, RH 85% (Max.)
Dimensions	60(W) x 50(H) x 99(L)mm



Mechanical IR-Cut Filter Built-in



Box Cameras

BC2002HQDNVL

Road & Highway License Plate Reading Box Camera

Specifications:

Image Sensor	1/3" Sony Super HAD CCD
DSP	Sony HQ1
Effective Pixels	811H x 508V
Scanning System	2:1 Interface
Resolution	540 TVL
S/N Ratio	> 50dB (AGC OFF)
Sync System	Internal
Min. Illumination	0.15 lux / F1.0
Electronic Shutter Speed	AES ON, AES OFF, 1/100(120) sec. FL: 1/130sec, 1/160sec, 1/210sec, 1/280sec, 1/360sec, 1/420sec, 1/560sec
B.L.C.	On / Off
A.G.C.	On / Off
Video Output	1Vp-p Composite
Power Consumption	250mA (3.0W)
Power Supply	12VDC / 24VAC
Operation Environment	- 10°C ~ 50°C, RH 80% (Max.)
Dimensions	60(W) x 50(H) x 99(L)mm



Features:

- 1/3" Sony Super HAD CCD
- 540 TVL, 0.15 Lux
- DSP: Sony HQ1
- Automatic Day & Night Function
- Dual Voltage 12VDC/24VAC
- Built-in Intelligent Shutter (CAR-DC Iris Control) Capturing License Plate of Vehicle Speed up to 90mph

BC2002WD

WDR Wide Dynamic Range Box Camera

Specifications:

Image Sensor	DPS (Digital Pixel System)
Resolution	550 TV Lines Resolution
Signal System	PAL & NTSC Selectable
S/N Ratio	More than 50dB
Dynamic Range	120dB Maximum
Min. Illumination	0.08 Lux (F1.2, slow shutter)
Control Method	OSD Function Control
Wide Dynamic Range	On/Off
White Balance	AWB / ATW NORMAL / ATW DESAT / MANUAL / ATW XTND Selectable
AWB Range	Auto 2000K ~ 11,000K
Video Output	1.0Vp-p Composite Video Output, 75Ω
Gamma	0.45
Sync Mode	Internal & Line-Lock Selectable
Auto Iris	DC Drive
Power Supply	12VDC / 24VAC
Power Consumption	4.5W (Max.)
Operating Environment	-10°C ~ 50°C, RH 90% (Max.)



Features:

- Digital Pixel System Image Sensor
- 0.08 Lux
- High Resolution up to 550 TV Lines Resolution
- Wide Dynamic Range: 120dB Max.
- Day and Night function
- Dual Voltage 12VDC / 24VAC

Box Cameras

BC3002HDN/12/24

550 TVL High Resolution Box Camera

Features:

- 1/3" Sony CCD
- 550 TV Lines of Resolution
- BLC & AGC Control
- Excellent Color Reproduction
- Remarkable Sensitivity / Auto White Balance
- Dual Voltage 12VDC ~ 24VAC

Specifications:

Image Sensor	1/3" Sony High Resolution CCD
Effective Pixels	510(H) x 492(V)
Resolution	550 TV Lines Resolution
Min. Illumination	0.05 lux/F1.2
S/N Ratio	>48dB
Electric Shutter	EE/AI Switchable
A.G.C.	On/Off
Day/Night	Yes
B.L.C.	On/Off
Video Out	BNC, 1.0Vp-p (75ohm)
Power Supply	12VDC / 24VAC
Power Consumption	150mA or less



BC6002HDN/12/24

Star-Light Day & Night Box Camera

Features:

- 1/3" Sony ICX 408/409AK Interline CCD
- Low Power Consumption
- High Sensitivity (Sense up Max 32 times 0.001 Lux)
- High Speed White Balance Mode
- DNR Function (Digital Noise Reduction)
- High Resolution 560 TVL (Color), 620 TVL (B/W)

Specifications:

Image Device	1/3" Sony ICX 408/409AK Interline CCD
Number of Pixels	512(H) x 492(V)
Resolution	560 TVL (Color), 620 TVL (B/W)
SYNC System	Internal
Scanning	2:1 Interlaces
S/N Ratio	52dB(Min)/60dB(Typ) (AGC Off)
Gamma Correction	0.45
Min. Illumination	0.01 Lux (B/W Mode), 0.001 Lux (Sense Up)
White Balance	ATW/ATB Switchable
AE/ALC	On/Off
B.L.C.	On/Off
Electrical Shutter	1/60 ~ 1/120,000 sec
Sense Up	Auto/Off
Power Supply	8VDC ~ 30VAC
Power Consumption	0.8W
Operation Temperature	14°F ~ 113°F



Regular Day & Night



32x Star Light Sense Up



Box Cameras

BC2002/AT30

30x Optical Zoom Box Camera

With Sony Ex-View CCD chip set, this camera provides excellent images and superb low lux rating for near complete darkness operation. The integrated zoom lens has a powerful 30x Optical Zoom making this camera ideal for longer range perimeter protection. It has an RS485 interface for control of camera functions, and the OSD (On Screen Display) menu makes it extremely easy in situations where remote setup of the camera is required.

Specifications:

Image Sensor	1/4" Sony Ex-View HAD CCD
Effective Pixels	768H x 494V
Horizontal Resolution	More than 480TVL
Zoom Ratio	30x Optical Zoom
Sync. System	Internal / External
S/N Ratio	> 55dB
Signal System	PAL / NTSC
Min. Illumination	0.01 Lux (ICR ON)
Shutter Speed	1sec ~ 1/10,000sec
OSD Menu	Yes
White Balance	Auto Tracking White Balance
Focusing System	Normal AF, Zoom Trigger AF
Picture Effect	Neg., Mirror, B/W
Control Interface	Line Control, RS485
Video Output	1.0Vp-p 75Ω (BNC)
Power Supply	12VDC
Power Consumption	150mA
Dimensions	58(W)mm x 65(H)mm x 116(D)mm
Operating Temperature	-10°C ~ 50°C



Supports RS485 Direct Connection to DVR / PC

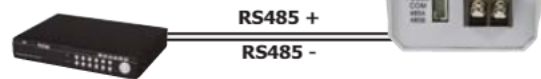

Features:

- 1/4" Ex-View SONY HAD CCD
- Low Power Consumption
- 30x Optical Zoom
- Wireless Remote Control with Effective Distance up to 300ft
- Multi-mode Focus
- High Sensitivity 0.01lux
- High Resolution more than 480TVL

BC2002/AT30R

30x Optical Zoom Box Camera with Remote Zoom Control

Specifications:

Image Sensor	1/4" Sony Ex-View HAD CCD
Effective Pixels	768H x 494V
Horizontal Resolution	More than 480TVL
Zoom Ratio	30x Optical Zoom
Sync. System	Internal / External
S/N Ratio	> 55dB
Signal System	PAL / NTSC
Min. Illumination	0.01 Lux (ICR ON)
Shutter Speed	1sec ~ 1/10,000sec
OSD Menu	Yes
White Balance	Auto Tracking White Balance
Focusing System	Normal AF, Zoom Trigger AF
Picture Effect	Neg., Mirror, B/W
Control Interface	IR Remote for Zoom/Focus
Video Output	1.0Vp-p 75Ω (BNC)
Power Supply	12VDC
Power Consumption	150mA
Dimensions	58(W)mm x 65(H)mm x 116(D)mm
Operating Temperature	-10°C ~ 50°C



BN5008

Advanced Professional WAN/LAN Box Camera

Bolide's WAN/LAN Cameras built in a high performance H.264 SP encoder will enable you to remotely view and record live video from anywhere in the world. Images can be viewed using video management software or a standard web browser. This network cameras has day and night capability for use indoors and outdoors, as well as over WI-FI connection.

Specifications:

Image Sensor	Digital Pixel System
Effective Pixels	768H x 494V
Horizontal Resolution	More than 540TVL
Sync. System	Internal
S/N Ratio	> 50dB
Min. Illumination	0.5 Lux / F1.2
White Balance	AWB/ATW/DESAT/EXTEND
Video Compression	H.264
Max Video Resolution	D1, 30FPS
Ethernet	10/100 Base-T, RJ45
Security	Password Protection
Alarm In/Out	1 In / 1 Out
Built-in recording	Mini SD
Audio Compression	G723.1/6.3kbps, Two way audio
Web Browser	IE 5.5 or higher
Power Consumption	12VDC, 1A
Dimensions	78(W)mm x 65(H)mm x 186(D)mm
Weight	840g



*Picture may vary from the actual item

Features:

- High resolution video - live and recorded.
- Multi-level password for maximum protection
- IP address filtering and HTTPS encryption
- Integrates both Network IP camera and DVR/NVR functions
- Powerful event and alarm management
- View real-time and playback history on both Intranet and Internet
- Powerful management tools for remote configuration and status

BN5008M

Advanced Professional Mega Pixel WAN/LAN Box Camera

Bolide's Mega Pixel Camera integrates clearer images, better networking, advance coding, remote PTZ controls and other surveillance controls. It is specialized for a variety of industries for example: Hospital management, Security surveillance of banking branches, school, commercial chain store/restaurant/retail monitoring and management. Management of large-scale enterprise sector, public place security/surveillance, and so on.



Specifications:

Image Sensor	Exview 1.3Mega Pixel
Effective Pixels	1280 x 960
Sync. System	Internal
Stream Range	10kb - 4M
Min. Illumination	0.2 Lux / F1.2
White Balance	AWB/ATW/DESAT/EXTEND
Compression	H.264
Max Video Resolution	1280x960, 22.5FPS
Ethernet	10/100 Base-T, RJ45
Security	Password Protection
Built-in recording	Mini SD
Audio Compression	G723.1/6.3kbps, Two way audio
Web Browser	IE 5.5 or higher
Power Consumption	12VDC, 1A
Dimensions	78(W)mm x 65(H)mm x 186(D)mm
Weight	830g



*Picture may vary from the actual item

Features:

- Mega Pixel video quality - live and recorded.
- Multi-level password for maximum protection
- IP address filtering and HTTPS encryption
- Integrates both Network IP camera and DVR/NVR functions
- Powerful event and alarm management
- View real-time and playback history on both Intranet and Internet
- Powerful management tools for remote configuration and status

Observation Systems

Quad Processors

BWQ-1

4 Channels B/W Quad Processor

Specifications:

Picture Refresh Rate	30 Frame/sec
Resolution	720x480
Video Input	4 Channel Video Input
Video Output	1 Monitor Output & 1 VCR Output
Display Mode	Full/Quad/Freeze/Auto Switch
Time & Date	Real Time Display
Freeze Image	1-4 Picture Freeze
OSD Menu	Yes
Motion Detection	Screen display, sound alarm & time adjustment

Features:

- Resolution: 720 x 480
- Real Time Display
- Function: Full/Quad/Freeze/Auto Switch
- Built-in Date Stamp
- Picture in Picture
- Motion Detection
- Zoom and VCR Looping



CQ-1

4 Channels Color Quad Processor

Specifications:

Picture Refresh Rate	30 Frame/Sec
Resolution	720x480
Video Input	4 Channel Video Input
Video Output	1 Monitor Output & 1 VCR Output
Display Mode	Full/Quad/Freeze/Auto Switch
Time & Date	Real Time Display
Freeze Image	1-4 Picture Freeze
OSD Menu	Yes
Motion Detection	Screen display, sound alarm, time adjustment

Features:

- Resolution: 720 x 480
- Real Time Display
- Function: Full/Quad/Freeze/Auto Switch
- Built-in Date Stamp
- Picture in Picture
- Motion Detection
- Zoom and VCR Looping



CQ-2

Dual Pages Color Quad Processor

Features:

- High Definition 720x480 60Hz
- Multiple Display Mode 1, 2, 4, 8, and Picture in Picture (PIP) automatic inverting mode
- High performance picture frozen function
- Display title of camera, real time display and warning date/video/moving detection information
- The four pictures and single picture mode recycle
- There are multiple modes: Warning input, video loss detection, moving detection can keep over 60 reports, the built in buzzer

Specifications:

Video Standard	60 field/sec
Resolution	720x480
Video Input	8 x 1.0Vp-p/75 ohm input
Tape Input	1.0Vp-p/75 ohm input
Tape Output	1.0Vp-p/75 ohm input
Alarm Mode	Video lost warning, touch and start mode moving detection warning
Video Input Mode	Full screen, electronic amplifying 8 pictures, 4 pictures, PIP, and automatic
Voltage	DC12/1A
Motion Detection	Screen display, sound alarm & time adjustment



Video Recorders

PVR

Portable Digital A/V Recorder



Features:

- Built-in 2GB Flash Memory for recording up to 5 hrs
- Built-in Rechargeable Li-Ion Battery
- 2.4 inch TFT LCD Display
- Supports Camera In/Out
- Built-in MIC/Line In/Line Out
- Video Supports: ASF (MPEG-4), AVI (DIVX, XVID), 3GP, MP4 format
- Built-in Speaker
- Supports SD/MMC card
- Supports High Speed USB 2.0 Data Transfer

PVR-CAM

Portable Camera Set for PVR

Features:

- Special Covert Design
- Built-in Camera / Microphone
- Powered by PVR
- No External / Recharge Power Required
- High Resolution CCD Camera for Maximum Quality Pictures



PVR-V5

Portable Digital A/V Recorder - V5

Features:

- Built-in Rechargeable Battery
- 2.5 inch TFT LCD Display
- 640*480 Resolution @ 30fps
- Direct 12VDC, 100mA to camera
- Video Supports: MP4 format
- Time Stamp function built-in
- Supports SD/MMC card 16Gb max.
- Supports High Speed USB 2.0 Data Transfer
- One push stop/record by optional control
- Automatic Overwrite, "First in, First out"



Mobile Recorders

AVR

Pocket Digital Motion Detection A/V Recorder

Features:

- The Motion Detection is immediately activated after powering on
- Automatically takes photos/records immediately when motion detected
- 128M SD card stores up to 2000 photos or 400 video clips
- Supports up to 2GB SD card
- Built-in 12VDC port for external camera
- Internal battery to memorize your pre-set parameter
- Output for direct playback on TV
- Recorded photos in (JPG) and video in (AVI) can be directly played back on PC, no software required

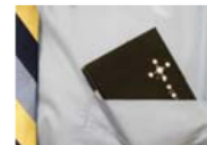

AVR-2

2 Channel Pocket Sized Digital Motion A/V Recorder

Features:

- Starts working immediately after powering on
- Automatically takes photos, and records when motion detected
- Can connect two cameras, and take photos while recording at the same time
- Supports a Maximum of two double 2Gb SD cards
Each store about 28800 photos or 2450 video clips
- Stored photos/video clips are secured even with power loss
- The parameters (Date, time, Detecting area, sensitivity and interval time etc.) can be reset by user, not lost after power off
- Supports both AVI format, and photos by JPEG format
- User Friendly Interface, no additional software required
- Connect to TV, Monitor, or Computer via SD card reader



CCTV Systems

Digital Video Recorders

Security Monitors

CCTV Cameras

Observation Systems

Telephone & Audio Devices

Covert Cameras

Parts & Accessories

Telephone & Audio Devices

CCTV Systems

Digital Video Recorders

Security Monitors

CCTV Cameras

Observation Systems

Telephone & Audio Devices

Covert Cameras

Parts & Accessories

Telephone Recorders

BT-5080

Voice Activation Telephone Recorder

**Features:**

- Voice activation
- Adjustable recording speed
- Power supply: AC/DC or Batteries
- Recording Time: Max. 90 mins
- Plug and play

BT-5045

Voice Activation Telephone Recorder

**Features:**

- Voice activation
- Adjustable recording speed
- Power supply: AC/DC or Batteries
- Recording Time: Max. 90 mins

BT-5085

Voice Activation Telephone Recorder

**Features:**

- Voice activation
- Adjustable recording speed
- Power supply: AC/DC or Batteries
- Recording Time: Max. 8 Hours
- Plug and play

BT-D140

140 Minutes Audio Tape

**Features:**

- 35% more recording time
- Long lasting design
- Compatible with all Bolide recorder
- Plug and play

BT-ATR12

12 Hour Telephone Recorder

**Features:**

- Voice activation
- Automatic level control
- Adjustable recording speed
- Power supply: AC/DC or Batteries
- Recording Time: Max. 12 Hours
- Plug and play

BT-PRO12

12 Hours Portable Telephone Recorder

**Features:**

- Voice activation
- Automatic tape reverse
- Adjustable recording speed
- Power supply: AC/DC or Batteries
- Recording Time: Max. 12 Hours
- Plug and play

BT-5090

Dialed Number Telephone Recorder

**Features:**

- Voice activation
- Adjustable recording speed
- Power supply: AC/DC or Batteries
- Recording Time: Max. 5 Hours
- Caller-ID service required
- Plug and play

Telephone & Audio Devices

Bug Defeater

BT-TLBS

Security Devices



Features:

- Protect your line from being taped
- Disable automatic recording devices, line transmitters, or any other voltage-activated devices

BT-TBSP

Security Devices



Features:

- Discover if your line is being tapped
- Green Led tells you your phone line status

BT-TLTD

Security Devices



Features:

- Automatically deactivates all known wire-tapping devices
- Voice simulation causes VOX equipment to record noise

Audio Devices

BT-DR

Dead Ringer



Features:

- This tiny device allows the user to create "Dead Lines".

BT-DN

Disconnected Number



Features:

- This unit never allows the phone to ring.

BT-TLBS

Bionic Ear and Booster



Features:

- Operates up to 100 yards
- High-powered Microphone included
- Great for outdoor use
- Can be connected with Recording devices

PRO-88W

Wireless Microphone System



Features:

- Up to 700 feet
- Can be connected with recording devices
- Microphone included
- Great for indoor use

BT-8083

Telephone Voice Changer



Features:

- A variety of settings allows for a huge range of vocal change
- High and Low voice adjustment
- Compatible with all phones

BT-8083ADV

Advanced Voice Changer



Features:

- Special design for cellular phone
- Compatible with all different phone
- 16 Pitch setting
- Better sound quality

Digital Recorder

BT-PSE

32MB, 64MB, 128MB and 256MB DIGITAL VOICE RECORDER

Features:

- Long Recording Time: up to 130 hours (256MB)
- Recording Quality Mode: XQ/HQ/SP/LP
- VOR Recording: Operates only when an audible sound exists
- Microphone Sensitivity: Adjustable sensitivity to the distance
- Power Supply Selection: DC supply and USB supply
- Playback Speed: 7 steps
- File Search: Easy Intro-Search available
- Hearing Aid: Adjustable sound levels for the best results

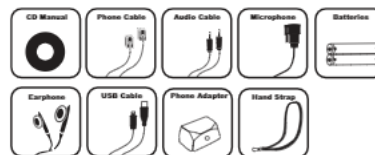

Covert Cameras

Hidden Cameras

Hidden Cameras

Wired and Wireless Hidden Camera Packages

At Bolide, we offer professional grade CCTV equipment and high quality hidden cameras for covert applications. All hidden cameras can be made as Hard-Wired or Wireless and are available in color or B/W.

Specifications:

Model	Covert Cameras
Image Sensor	1/4" CCD (Color)
Effective Pixels	512H x 492V (250k pixels)
Scanning System	525 Lines 2:1 Interlace
Resolution	380 TV Lines Resolution (Color)
Shutter Speed	1/60 ~ 1/100,000 sec
S/N Ratio	More than 45 dB (AGC off)
Sync. System	Internal
Min. Illumination	0.5 Lux (Color)
White Balance	AWB
Power Consumption	100mA (DC12V)



BC1012/MRS

Professional Spy Camera with MPEG4 Portable Video Recorder (Button/Sunglasses)

"WHAT YOU SEE IS WHAT YOU RECORD"

Package Includes:

- Sunglasses Hidden Camera OR Button Hidden Camera
- 380 TV Lines Resolution, 1 Lux
- MPEG4 Portable Recorder with SD Card Slot
- Battery Pack Included



BC1008, BC1008M

PIR Hidden Camera (Optional Working Sensor)



Specifications:

Image Sensor	1/4" CCD (Color)
Effective Pixels	512H x 492V (250k pixels)
Scanning System	525 Lines 2:1 Interlace
Resolution	420 -450 Lines (Color)
Shutter Speed	1/60 ~ 1/100,000 sec
S/N Ratio	More than 45 dB (AGC off)
Sync. System	Internal
Min. Illumination	0.5 Lux (Color)
White Balance	AWB
Power Consumption	100mA (DC12V)

BC1010, BC1038

Smoke Alarm Hidden Camera



Specifications:

Image Sensor	1/4" CCD (Color)
Effective Pixels	512H x 492V (250k pixels)
Scanning System	525 Lines 2:1 Interlace
Resolution	420 -450 Lines (Color)
Shutter Speed	1/60 ~ 1/100,000 sec
S/N Ratio	More than 45 dB (AGC off)
Sync. System	Internal
Min. Illumination	0.5 Lux (Color)
White Balance	AWB
Power Consumption	100mA (DC12V)

Covert Cameras

Hidden Cameras

CCTV Systems

Digital Video Recorders

Security Monitors

CCTV Cameras

Observation Systems

Telephone & Audio Devices

Covert Cameras

Parts & Accessories

SC2400SYS-2

2.4Ghz Micro Wireless Camera w/ LCD

Features:

- Imaging Sensor: 1/3" CMOS
- Horizontal Resolution: 380TV Lines
- Light Sensitivity: 1.0Lux / F2.0
- Video Gain Control: Automatic
- Demodulation Mode: FM
- Antenna: Monopole Antenna
- Dimensions: 130x80x38



BL1188MOD

2.4Ghz Micro Wireless Transmitter / Receiver

Features:

- Frequency: 2.4GHz
- Receiving Sensitivity: -85dBm
- Built-in Channel Switch
- Support up to 4 channels
- Up to 700 ft Line of sight
- Size: 38.4mm x 34.5mm x 32.4mm



SC2400

2.4Ghz Micro Wireless Camera

Features:

- Color: 380 TV Lines Resolution, 0.5 Lux
- S/N Ratio > 50dB
- Shutter Speed: 1/60 ~ 1/100,000 Sec
- Range up to 700 ft line of sight
- Includes video receiver
- Power: 12VDC



SC2400IR

2.4Ghz Infrared In\Outdoor Camera

Features:

- Color: 380 TV Lines Resolution, 0.5 Lux
- S/N Ratio > 50dB
- Range up to 700 ft line of sight
- Includes video receiver
- 12VDC



SD Card Covert Cameras

Covert Camera with SD Card DVR Built-in

"Ready to Go" SD Card DVR Hidden Camera Packages

With our new recording technology in our Hidden / Nanny Camera, we have eliminated the need for additional recording equipment in a covert system. With Motion Detection and Time & Date Stamp features, the hidden camera records directly onto a SD card for storage and it can be easily played back on your PC. Offering several styles and many features at an affordable price that makes our hidden cameras the only all-in-one solution.

Features:

- Video System: NTSC
- Time & Date Stamp During Playback on Unit
- Video Format: JPG, 3GP
- Video Recording Modes: Manual / Motion Activation
- USB Connection for PC
- No Professional Installation Required



Covert Camera with DVR Built-in

Plug and Play Hidden Camera Packages

Features:

- Video System: NTSC
- Record up to 8 Hrs Video with Internal Memory
- Video Format: AVI
- Video Recording Modes: Continuous
- USB Connection for PC and charging
- No External Power Required, Battery Operated
- No Professional Installation Required



"In-Car" Series Covert Camera with DVR

An invisible guard in your car

Features:

- Record up to 8 Hrs Video with Internal Memory
- Video Format: AVI
- USB Connection for PC and charging
- No External Power Required, Battery Operated
- No Professional Installation Required



Covert Cameras

Snake Cameras

BE-CS55AIR/5V, BE-CS55AIR/12V

5V/12V Professional Snake Camera with Flash Light

Features:

- 1/8" DSP Color CCD
- High Resolution: 420 TV Lines Resolution
- 3.7mm Pinhole Lens
- High Power LED light for dark operation
- DC5V 200mA, DC12V 140mA



Specifications:

Image Sensor	1/8" DSP CCD (Color)
Effective Pixels	450H x 432V
Scanning System	525 Lines 2:1 Interlace
Resolution	420TV Lines Resolution (Color)
Minimum Illumination	1 Lux (leds off)
Shutter Speed	Up to 1/100,000 sec
Scanning System	2:1 Interlace
Sync. System	Internal
S/N Ratio	More than 48 dB (AGC off)
Lens	3.7mm Pinhole Lens
White Balance	ATW
Gamma	0.45
Auto Gain Control	Auto
Power Supply	DC5V / DC12V
Power Consumption	200mA / 140mA
Weight	50g



PVR

Portable Digital A/V Recorder

Features:

- Built-in 2GB Flash Memory for recording up to 5 hrs
- Built-in Rechargeable Li-Ion Battery
- 2.4 inch TFT LCD Display
- Supports Camera In/Out
- Built-in MIC/Line In/Line Out
- Video Supports: ASF (MPEG-4), AVI (DIVX, XVID), 3GP, MP4 format
- Built-in Speaker
- Supports SD / MMC card
- Supports High Speed USB 2.0 Data Transfer



Specifications:

Built-in Flash	2GB
Power Supply	Li-Ion Battery
LCD	2.4 inch TFT
Signal to Noise Ratio	90dB
Earphone Output	5mW + 5mW
Output Frequency Range	60Hz - 16KHz
Video Format	ASF, AVI, 3GP, MP4
Audio In/Out	1 In / 1 Out
Storage Media	MMC, SD up to 16GB
Speaker	Built-in
Dimension	83.5 x 50.2 x 12.5mm
USB Port	USB 2.0

Works best with our portable camera.



*Camera not included.

CCTV ACCESSORIES



CCTV Systems

Digital
Video Recorders

Security Monitors

CCTV Cameras

Observation Systems

Telephone &
Audio Devices

Covert Cameras

Parts &
Accessories

Parts & Accessories

Professional Cables

Our professional grade cables are what you need to ensure an easy, cleaner and more efficient camera installation. We provide Quality Siamese RG59+18/2, RG59, RG6 along with Alarm Wire, CAT5/CAT6 cables. Bolide NEW specialty IP Camera cable is perfect for IP cameras and PTZ applications. All cables feature sequential foot markers and are UL certified.



RG59 Siamese Cable

Description	Part No.	Length (ft)	Dielectric	Conductor / Shielding	Jacket	Nom. Imp. (Ω)	Vel. of Prop.	Nominal Attenuation	
								Mhz	db/100ft
RG-59/U, 20 AWG Power 18-2, 18AWG	BP0033	500ft	Gas Injected Foam PE	Bare Copper / 95% Coverage	75°C PVC U/V White	75	82%	1Mhz	0.33
RG-59/U, 20 AWG Power 18-2, 18AWG	BP0033/B	500ft			75°C PVC U/V Black			10Mhz	0.88
RG-59/U, 20 AWG Power 18-2, 18AWG	BP0033/1000W	1000ft			75°C PVC U/V White			50Mhz	1.85
RG-59/U, 20 AWG Power 18-2, 18AWG	BP0033/1000	1000ft			75°C PVC U/V Black			100Mhz	2.51
								200Mhz	3.58
								400Mhz	5.29
								700Mhz	7.45
								900Mhz	8.7
								1000Mhz	9.31

RG59 Zip/Combo Cable



Description	Part No.	Length (ft)	Dielectric	Conductor / Shielding	Jacket	Nom. Imp. (Ω)	Vel. of Prop.	Nominal Attenuation	
								Mhz	db/100ft
RG-59/U, 20 AWG Power 18-2, 18AWG	BP0033C	500ft	Gas Injected Foam PE	Bare Copper / 95% Coverage	75°C PVC U/V White	75	82%	1Mhz	0.33
RG-59/U, 20 AWG Power 18-2, 18AWG	BP0033/CB	500ft			75°C PVC U/V Black			10Mhz	0.88
RG-59/U, 20 AWG Power 18-2, 18AWG	BP0033/CW1000	1000ft			75°C PVC U/V White			50Mhz	1.85
RG-59/U, 20 AWG Power 18-2, 18AWG	BP0033/CB1000	1000ft			75°C PVC U/V Black			100Mhz	2.51
								200Mhz	3.58
								400Mhz	5.29
								700Mhz	7.45
								900Mhz	8.7
								1000Mhz	9.31

RG59 CCTV Cable



Description	Part No.	Length (ft)	Dielectric	Conductor / Shielding	Jacket	Nom. Imp. (Ω)	Vel. of Prop.	Nominal Attenuation	
								Mhz	db/100ft
RG-59/U, 20 AWG	BP0033/RG59	500ft	Gas Injected Foam PE	Bare Copper / 95% Coverage	75°C PVC U/V White	75	82%	1Mhz	0.33
					75°C PVC U/V Black			10Mhz	0.88
								50Mhz	1.85
								100Mhz	2.51
								200Mhz	3.58
								400Mhz	5.29
								700Mhz	7.45
								900Mhz	8.7
								1000Mhz	9.31

Professional Cables

RG6 CATV Cable

Description	Part No.	Length (ft)	Color	Conductor / Shield	Nom. Imp. (Ω)
RG6, 18AWG	BP0033/RG6	1000ft	WHT	BCC / 60% Alum. Foil coverage	75
RG6/Quad, 18AWG	BP0033/RG6Q	1000ft	WHT	BCC / 2 x 60% Alum. Foil coverage	



Audio, Security & Alarm Cable

Description	Part No.	Length (ft)	Color	Conductor/ Jacket
1 Pair, 22AWG/2	BP0033/22-2	1000ft	WHT	BCC / PVC
2 Pairs, 22AWG/4	BP0033/22-4	1000ft	WHT	BCC / PVC
3 Pairs, 22AWG/6	BP0033/22-6	1000ft	WHT	BCC / PVC

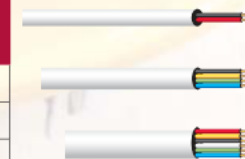

CAT5e Twisted Pair Networking Cable

Description	Part No.	Length (ft)	Color	Conductor/ Jacket	Cable Characteristic	
					Parameter	dB
4-Pair 100Ω UTP 24AWG 350Mhz Swept Test	BP0033/Cat5e	1000ft	Grey Blue White Yellow	BCCA / PVC	Attenuation	12.8
					NEXT	30.9
					PSNEXT	36.7
					ELFEXT	18.8
					PSELFEXT	15.8
					ACR	46.0
					PSACR	43.8
RL	17.0					



IP Camera Cable with Power

Description	Part No.	Length (ft)	Color	Conductor/ Jacket	Cable Characteristic	
					Parameter	dB
4-Pair 100Ω UTP 24AWG 350Mhz Swept Test, Power 18-2, 18AWG	BP0033/IP	1000ft	White	BCCA / PVC	Attenuation	12.8
					NEXT	30.9
					PSNEXT	36.7
					ELFEXT	18.8
					PSELFEXT	15.8
					ACR	46.0
					PSACR	43.8
RL	17.0					



CAT6 Twisted Pair Networking Cable

Description	Part No.	Length (ft)	Color	Conductor/ Jacket	Speed
4-Pair 100Ω UTP 24AWG 250Mhz Swept Test	BP0033/Cat6	1000ft	Blue White	BCCA / PVC	Gigabit Ready



CCTV Systems

Digital Video Recorders

Security Monitors

CCTV Cameras

Observation Systems

Telephone & Audio Devices

Covert Cameras

Parts & Accessories

Premade Cables

RG59 Coaxial Premade Cable

25ft, 60ft, 100ft, 150ft & 200ft BNC Compressed with 18/2

Features:

- RG59 Coaxial Cable for Maximum Video Quality
- Ready for install
- Includes Power Connectors



BP0033/PM25 - 25FT RG59 Coaxial Premade Cable
 BP0033/PM60 - 60FT RG59 Coaxial Premade Cable
 BP0033/PM100 - 100FT RG59 Coaxial Premade Cable
 BP0033/PM150 - 200FT RG59 Coaxial Premade Cable
 BP0033/PM200 - 200FT RG59 Coaxial Premade Cable



RCA Premade Cable

25ft, 60ft, 100ft & 300ft RCA Multi-media Cable

BP0013 - 60FT Super Grade RCA Premade Cable
 BP0014 - 100FT Super Grade RCA Premade Cable
 BP0015 - 300FT Super Grade RCA Premade Cable

CCTV Lens

Bolide Aspherical Lens

Professional Japan Made Lens for CCTV Cameras

Fixed Lens Specifications:

Model No.	Focal Length	Aperture	Mount	Angle of View	M.O.D	Weight
BP0002-2.5	2.5mm	1.8	CS	107.1°	0.2m	36g
BP0002-4.0	4.0mm	1.6	CS	70.6°	0.1m	51g
BP0002-6.0	6.0mm	1.6	CS	48.1°	0.1m	54g
BP0002-8.0	8.0mm	1.6	CS	33.4°	0.1m	59g
BP0002-12.0	12.0mm	1.6	CS	22.1°	0.1m	42g
BP0002-16.0	16.0mm	1.6	CS	17.1°	0.1m	47g

Vari-Focal Auto Iris Lens Specifications:

Model No.	Focal Length	Aperture	Mount	Angle of View	M.O.D	Weight
BP0019-12	2.8-12mm	1.4	CS	95.6° - 22.1°	0.1m	156g
BP0019-8.0	3.5-8.0mm	1.4	CS	81.9° - 35°	0.1m	104g
BP0019-15	6.0-15mm	1.4	CS	48.1° - 18.6°	0.1m	133g
BP0019-30	12-30mm	1.6	CS	21.9° - 9.6°	0.2m	128g
BP0019-60	6.0-60mm	1.6	CS	49.3° - 4.7°	0.2m	167g
BP0019-100	5.0-100mm	1.8	CS	50.1° - 2.8°	0.2m	242g

Board Lens Specifications:

Model No.	NEAR Focal Length	Aperture	Mount	Angle of View	M.O.D	Weight
BP0001-3.6	3.6mm	2.0	12*0.5	92°	0.2	2.8-52mm
BP0001-6.0	6.0mm	2.0	12*0.5	54°	0.2	5
BP0001-8.0	8.0mm	2.0	12*0.5	43°	0.2	5
BP0001-12.0	12.0mm	2.0	12*0.5	29°	0.2	5
BP0001-16.0	16.0mm	2.0	12*0.5	21°	0.2	5

Mega Pixel Lens Specifications:

Model No.	Focal Length	Aperture	Mount	Angle of View	M.O.D
BP0019MP-8.0	3.5-8.0mm	1.4	CS	96° - 42°	0.2
BP0019MP-22.0	9.0-22mm	1.6	CS	40° - 18°	0.2
BP0019MP-60.0	6.0-60mm	1.6	CS	76° - 8.8°	0.2



CCTV Systems

Digital Video Recorders

Security Monitors

CCTV Cameras

Observation Systems

Telephone & Audio Devices

Covert Cameras

Parts & Accessories

CCTV Bracket & Housing

CCTV Systems

Digital
Video Recorders

Security Monitors

CCTV Cameras

Observation Systems

Telephone &
Audio Devices

Covert Cameras

Parts &
Accessories

BP0021/13, BP0021/39 BP0051

Aluminum Mounting Bracket

Features:

- Heavy-duty in / outdoor
- Max-Load 8.5 lbs.
- Swivel Angle 360°

BP0021/13" (12"-15")
BP0021/39" (24"-42")



Pendant Dome Covers

Features:

- Excellent focus from horizon to crown
- Extremely clean for fine resolution camera applications
- Size: 8.5" x 8.5"
- Available in different colors
Gold, Clear, Smoke



BP0052

Special Ceiling Camera Enclosures

These camera enclosures are easy to install and offer many advantages: complete visibility of an area, stealthy camera position and the ability to relocate or re-aim cameras without revealing their views. All of these domes and the flat tile are constructed of see-thru break resistant acrylic.

Features:

- Excellent focus from horizon to crown
- Includes dust cover and pre-cut liner
- Includes adjustable swivel head mount
- Available in different colors



BP0022, BP0034

Housing with Optional Heater & Blower

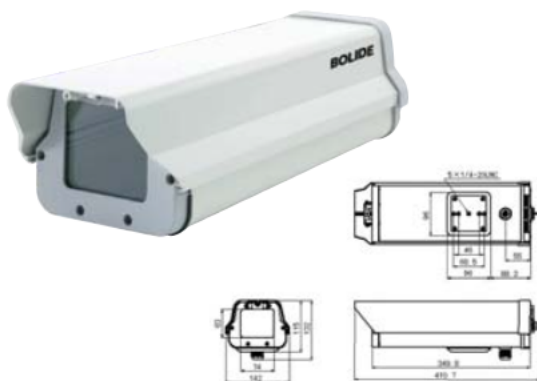

Features:

- Heavy-Duty Beige Aluminum Construction
- 15" Environmental Housing
- Dimensions: 15.5"L x 5.8"W x 4.3"H (With Visor)
- Latch Adjustable Camera Tray
- Optional: Heater & Blower (BP0034)

BP0009

In/Outdoor Brackets

Features:

- Adjustable Pan and Tilt Head
- Maximum Adjustment: 360° pan/ 90° tilt
- Ideal for indoor / outdoor use



BP0020

Heavy Duty In/Outdoor Brackets

Features:

- Heavy-Duty Construction
- Adjustable Pan and Tilt Head
- Maximum Adjustment: 360° pan/ 90° tilt
- Ideal for indoor / outdoor use



Parts & Accessories

Connectors

Professional Connectors

Model	Description
A. BP0005	RCA female couple
B. BP0006	RCA male to BNC female connector
C. BP0023	RCA female to BNC male connector
D. BP0026	BNC "T" connector
E. BP0027	BNC female to BNC connector
F. BP0028	Male RCA to male RCA coupler
G. BP0035	BNC Twist-On male connector
H. BP0036	BNC Crimp-On

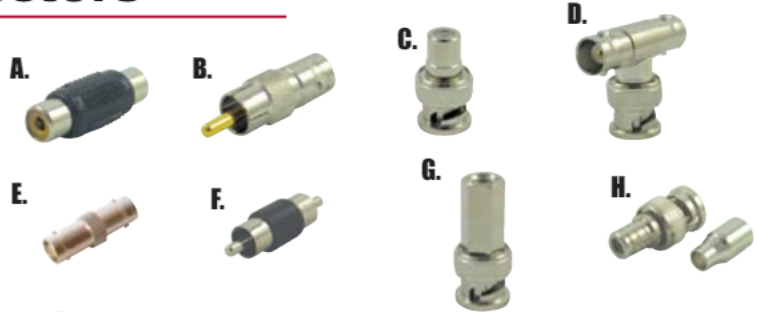

Compression Connectors

Features:

- 360-degree true radial compression
- No Guesswork involved
- Water-proof ring included
Available in RCA or BNC



Compression Tool

The Multi - Function Compression tool for BNC/RCA Connectors has a Durable Frame made out of black oxide steel along with interchangeable die sockets.

Features:

- Cable stripper
- Interchangeable die sockets
- Easy to use

*Please call about how to get your tools FREE



Power Accessories

Model	Description
A. BE-DC	DC Power Connector
B. BE-DC/Fem-Fem	DC Female to Female Connector
C. BE-DIS/Mal-2Fem	DC Male to 2 Female Pigtail
D. BE-DIS/Mal-2Fem	DC Female to 2 Male Pigtail
E. BE-DIS/Mal-4Fem	DC Male to 4 Female Pigtail
F. BE-DC/MM	DC Male to Male Couple
G. BE-DC/FF	DC Female to Female Couple
H. BP0029/12	24VAC to 12VDC Power Converter



CCTV Tools

CCTV Tester

Features:

- 2.5" LCD with Sun Shield Cover
- Supports Multi-Protocol, Pelco-D, Pelco-P, Panasonic, Kala-tel, Samsung and more
- Supports 1200, 2400, 4800, 9600, 192000, 384000 bps
- Full function PTZ control
- Selectable address: 1 - 255
- Network Cable Tester with detail report
- Control Interface: RS485, RS232, RJ45
- RS485 Polarity Tester
- Built-in Audio
- Battery operated / 12VDC
- Rechargeable battery included

Model: BE-337



CCTV Systems

Digital Video Recorders

Security Monitors

CCTV Cameras

Observation Systems

Telephone & Audio Devices

Covert Cameras

Parts & Accessories

CCTV Tools

Universal Cable Tracker

Features:

- Judge continuity of the cables or wires
- Track the cables or wires, and diagnose the break point
- Receive the tone signal on the cables or wires
- Identify the state in the working telephone line (clear, ring, busy)
- Send a single solid tone or a dual alternating tone to the object cables or wires
- Ideal for CCTV or Phone line installation

Model: BP-UCT



CCTV Systems

Digital Video Recorders

Power Supplies

BP0029

24 VAC Transformer 40VA



BP0004/S

12 VDC Switching Adapters

Available in 500mA and 1500mA



BP0049

24 VAC Power Supplies



Features:

- 24VAC 100W/200W
- Support up to 18 Output
- On / Off switch
- Fault & AC on LEDs

BP0050

12 VDC Power Supplies



Features:

- 12VDC, available in 5, 10, 29 Amps
- Support up to 18 Output
- On / Off switch
- Fault & DC on LEDs

Security Monitors

CCTV Cameras

CCTV Baluns

BE8016/P, BE8016/P4

Passive Video Baluns



Features:

- Passive Video Transceiver, No power required
- Color: 400 meters, B/W: 600 meters
- Use Cat5 UTP cables to transmit video signal
- Fast, easy installation and Superb quality

BE8016/AR, BE8016/AR4

Active Video Baluns



Features:

- Color: 1500 meters, B/W: 2400 meters
- Use Cat5 UTP cables to transmit video signal
- Fast, easy installation and Superb quality
- BE8016/AR4 supports up to 4 channels

Observation Systems

Telephone & Audio Devices

BE8019

BNC Video to VGA Converter

Features:

- Specially designed for computer CRT monitor and LCD color monitors
- Multi Signal inputs: VGA, Composite Video, S-Video.
- Support NTSC, PAL video system
- Output mode: 800 x 600, 1024 x 768, up to 1280*1024@60Hz
- On screen display function: Contrast, Brightness, Color, Tint



Covert Cameras

Parts & Accessories

Common Terms in CCTV

CCTV Systems

Digital Video Recorders

Security Monitors

CCTV Cameras

Observation Systems

Telephone & Audio Devices

Covert Cameras

Parts & Accessories

A.I.C (Automatic Level Control)

This function allows the auto iris circuitry to either take bright spots more into consideration (peak), bringing out detail in bright areas or less into consideration (average) bringing out detail in shadows. In another words, it makes the image clearer under different light conditions. This function is built in most of our cameras. It is either built-in ALC or manually switches on.

Automatic Gain Control (AGC)

An electronic circuit that automatically adjusts the gain of a signal as a function of its input or other specified parameter. For example, if the video signal is dark, it will attempt to increase the gain to bring the brightness up to a normal level.

Auto-Iris lens

The automatic iris lens (mechanical diaphragm) that adjusts automatically to allow a specific amount of light to be passed to the image sensor. When there is too much light, the iris lens will close to reduce the amount of light that gets in. When there is little light, the iris lens will open to allow more light to get in. Auto iris lens are usually used in black where light levels vary.

Balun

Balun stands for Balanced - Unbalanced. It is a device used to interface between balanced lines and unbalanced lines. For example, twisted pair to coaxial.

B.L.C. (Back Light Compensation)

Electronically compensates for high background lighting, giving detail to objects which normally would be silhouetted.

BNC

BNC stands for Bayonet Nut Connector which is commonly used in the CCTV industry. This connector has a center pin connected to the center cable conductor and a metal tube connected to the outer cable shield. A rotating ring outside the tube locks the cable to any female connector.

C Mount Lens & CS Mount Lens

There are two main types of lens used in CCTV cameras. The C mount lens has a flange back distance of 17.5mm. The CS mount lens has a flange back distance of 12.5mm. C mount lenses therefore have a longer focal distance. CS mount became widely used, because it is more practical for many of today's more compact cameras. Lenses are often supplied with a 5mm spacer ring (sometimes called a C ring) that allows a C mount lens to be used on a CS camera. Most modern cameras are CS.

CCD (Charged Coupled Device)

This is a solid-state semiconductor-imaging device often referred to as an integrated circuit, chip or "imager". Solid-state cameras are often referred to as CCD cameras.

CCTV

It is the abbreviation for Closed Circuit Television, which is a private or closed television system.

DVR

The abbreviation for Digital Video Recorder. Unlike the traditional method, video is recorded on magnetic tape. With DVR, video is recorded digitally on a hard-disk which gives you fast playback and specific time searching.

Day and Night Function

Day/Night CCTV security cameras allow your CCTV system to be effective even in the lowest of light conditions while still showing clear color pictures during daylight hours. Day/Night CCTV cameras will automatically change from color images to night vision when the light levels drop below a certain level.

Infrared (IR)

Illuminates light frequencies that are not visible by the naked eye but can be seen by a CCD camera. This is used when monitoring a pitch dark environment.

IP Waterproof Rating (IP66 - IP68)

IP ratings are a BSI standard measurement for how waterproof something is. Many cameras or camera housings are designed for outdoor use, and therefore need to be waterproof to some degree. The details of the tests are defined in BS EN 60529 : 1992. The IP number has two digits, and optional letters after them.

Lux

A unit measuring the intensity of light. Full Daylight is about 10,000 lux whereas full moon light is about 0.1 lux.

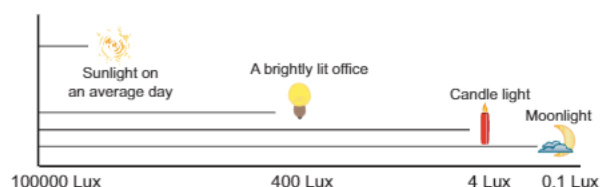

Microwave

A very efficient transmission band used for sending video signal or audio signal via wireless. Typical microwave video links use the following frequencies: 900MHz, 1.2 GHz and 2.4 GHz.

Quad Processor

Quad processor allows viewing of up to four cameras simultaneously on one screen. It also allows the VCR to record all cameras at the same time. With a Quad processor you do not need a camera switcher to change between camera views. The main advantage of quad processor is while you view one camera, you can keep the other 3 on the screen or just a button push away.

RCA

An RCA connector is a plug and a jack designed for use with coaxial cable. This is the most common connection type for audio and video.

Vari-focal Lens

A lens with a variable focal length. It may be used as a wide angle, standard or telephoto lens. With the vari-focal lens, you can change the focal length to zoom in or zoom out. Many different types are available including both manual and motorized versions.

WDR (Wide Dynamic Range)

WDR cameras record 2 images in high shutter speed and low shutter speed, and generates clearer images of the subject by extracting highlights and shadows from the two shots and then combining them into a single detailed image.



White Balance

The white balance function is for color cameras only. It helps to correct different color temperature because different lighting sources provide different color temperatures. With the white balance features, the camera adjusts the color processing to bring the color temperature to a fixed level.



BOLIDE
TECHNOLOGY GROUP



<http://www.bolideco.com>

468 South San Dimas Avenue, San Dimas CA 91773 | Tel: (909) 305-8889 | Fax: (909) 305-0999

