

# 30 mm Push Button Specifications

Bulletin Numbers 800T, 800H

Topic	Page
<b>Specifications</b>	3
Standards Compliance and Certifications	4
Contact Ratings	4
<b>Assembled Stations</b>	6
<b>Emergency Stop Devices (Trigger Action)</b>	7
2-position – Non-illuminated	7
2-position – Illuminated	8
<b>Push Button Devices</b>	9
Momentary Contact Devices – Non-illuminated	9
Momentary Contact Devices – Illuminated	10
Momentary Contact Devices with Two-color Molded Legend Caps – Non-illuminated	11
<b>Selector Switch Devices</b>	13
2-position – Non-illuminated	13
2-position Cylinder Lock (Bulletin 800T Only) – Non-illuminated	14
3-position – Non-illuminated	15
3-position Cylinder Lock (Bulletin 800T Only) – Non-illuminated	16
4-position – Non-illuminated	17
4-position Cylinder Lock (Bulletin 800T Only) – Non-illuminated	18
Cam Target Tables	19
2-position Knob/Lever Type – Illuminated	20
3-position Knob/Lever Type – Illuminated	21
<b>Pilot Light Devices</b>	22
Typical Pilot Light Wiring Diagrams	23
<b>Push-pull and Push-pull/Twist Release Devices</b>	24
2-position – Non-illuminated	24
3-position – Non-illuminated	25
2-position – Illuminated	26
3-position – Illuminated	27
<b>Specialty Devices</b>	28
Potentiometer Devices	28
Mechanically Interlocked Maintained Push Button Devices	29
18 mm Small Pilot Lights Type 4/13, Class I, Division 2	29
Cluster Pilot Light Devices (Bulletin 800T Only)	30
1-, 2-, 3-, 4-way Toggle Switches (Bulletin 800T Only)	31
Selector Push Button Devices (Bulletin 800T Only)	33
Cylinder Lock Push Button Devices (Bulletin 800T only)	34
Momentary Padlocking Mushroom Head Devices (Bulletin 800T only)	34
Momentary Wobble Stick Push Button Devices (Bulletin 800T Type 13 only)	34
Break-Glass Push Button Stations (Bul. 800T only)	36

Topic	Page
<b>Custom-Built Stations/Enclosures</b>	37
<b>Accessories</b>	39
Contact Blocks	39
Power Modules	43
Universal LED Module	43
Trigger Action E-stop Latches	43
Replacement Color Caps	44
Selector Switch Knobs – Illuminated	46
Selector Switches	46
Booted Selector Switch Knobs (800H only) – Non-illuminated	46
Protective Boots	47
Potentiometer Replacement Knobs	48
Push Buttons	48
Miscellaneous	49
Locking Attachments	50
Guards	52
Replacement Lamps	53
Replacement Keys for Cylinder Lock 2-, 3-, and 4-position Selector Switches (Bulletin 800T only)	54
Replacement Keys for Push Button Switches with Cylinder Locks (Bulletin 800T only)	54
Legend Plates – Aluminum, Type 4/13 (Bulletin 800T)	55
Legend Plates – Plastic, Type 4/4X/13 (Bulletin 800H)	58
<b>Approximate Dimensions</b>	61
<b>800H General-purpose Enclosures</b>	74

---

# Summary of Changes

This publication contains the following new or updated information. This list includes substantive updates only and is not intended to reflect all changes.

Topic	Pages
Added footnotes for noncompliance with EN ISO 13850.	49, 56, 57, 59, 60

**IMPORTANT** Performance data that is given in this publication is provided only as a guide for you to determine suitability and do not constitute a performance warranty of any kind. Such data may represent the results of accelerated testing at elevated stress levels, and you are responsible for correlating the data to actual application requirements. ALL WARRANTIES AS TO ACTUAL PERFORMANCE, WHETHER EXPRESS OR IMPLIED, ARE EXPRESSLY DISCLAIMED.

**Table 1 - Electrical Ratings**

Attribute	Bulletin 800T and 800H
Contact ratings	See the contact ratings tables on <a href="#">page 4</a> .
Dielectric strength	2200V for 1 minute, 1300V for 1 minute (Logic Reed)

**Table 2 - Mechanical Ratings**

Attribute	Bulletin 800T and 800H			
Vibration	10...2000 Hz, 0.06 in. (1.52 mm) displacement (peak-to-peak) max/10 G max (except Logic Reed)			
Shock	1/2 cycle sine-wave for 11 ms $\geq$ 25 g (contact fragility) and no damage at 100 g			
Degree of protection	Type 1/4/12/13 (800T); Type 1/4/4X/12/13 (800H); EN/IEC 60529 IP66/65			
Mechanical design lifecycles, min	Push buttons	Momentary, non-illuminated, flush, and extended head	10,000,000	
		Momentary, illuminated	250,000	
		Push-pull/twist-to-release	250,000 <sup>(1)</sup>	
	Selector switches	Non-illuminated	1,000,000	
		Illuminated, key-operated	200,000	
	Potentiometers	25,000		
All other devices	200,000			
Contact block operation	Shallow, mini, and low-voltage	Slow, double make and break		
	Logic reed and sealed switch	Single break magnetic		
Wire gauge/terminal screw torque	#18...14 AWG (#18...10 MaxDuty) / 6...8 lb•in			
Typical operating forces	Operators without contact blocks		<ul style="list-style-type: none"> <li>Flush, extended button, standard mushroom, jumbo plastic mushroom: 2 lb max</li> <li>Jumbo and extended aluminum mushroom head: 3.95 lb max</li> <li>Maintained selector switch: 3.6 in•lb max</li> </ul>	
	Spring-return selector switches		3.6 in•lb to stop, 0.2 in•lb to return	
	Illuminated push buttons and push-to-test pilot lights		5 lb max	
	2-position push-pull		8.0 lb max push or pull	
	3-position push-pull		8 lb max push to in position or pull to center position (15 lb max pull to out position)	
	Twist-to-release or push-pull		9 lb max push or pull 30 in•oz max twist, 6 in•oz min return	
	Potentiometer		Rotational torque 3...12 in•oz; stopping torque 12 in•lb (min)	
	Contact blocks	Standard	1 lb	
		Logic Reed and stackable sealed switch	1 lb max	
		Sealed switch	3 lb max at 0.205 in. (5.2 mm) plunger travel	
MaxDuty and PenTUFF™		1.4 lb max		
Self-Monitoring		1.6 lb		

(1) Illuminated trigger action E-stops are rated for 150,000 minimum mechanical operations when using Cat. No. 800TC-XD4S self-monitoring contact blocks (SMCBs).

**Table 3 - Environmental Ratings**

Attribute		Bulletin 800T and 800H
Temperature Range	Operating <sup>(1)</sup>	-13...+104 °F (-25...+40 °C)
	Storage	-40...+185 °F (-40...+85 °C)
Humidity		50...95% RH from 77...140 °F (25...60 °C) per Procedure IV of MIL-STD-810C, Method 507.1 cycling test

(1) Operating temperatures below freezing are based on the absence of moisture and liquids. Consult your local Rockwell Automation sales office or Allen-Bradley distributor for use in lower temperature applications.

**Table 4 - Materials Used in Bulletin 800H Type 4X Operators**

Material	Where Used
Thermoplastic Polyester (Fiberglass Reinforced)	Bushings, mounting rings, and sockets
Transparent Amorphous Nylon	Pilot light lens cap and illuminated button caps
Mineral-filled Nylon	Trim washer
Thermoplastic Polyester	Non-illuminated button caps
Glass-filled Crystalline Nylon	Thrust washer
Nitrile (Synthetic Rubber)	Gaskets and internal seals

## Standards Compliance and Certifications

Standards Compliance	UL 508, CCC
Certifications	<ul style="list-style-type: none"> <li>UL Listed (File No. E14840, E10314 Guide No. NKCR, NOIV, NISD)</li> <li>CSA Certified (File No. LR1234, LR11924)</li> <li>CSA C22.2, No. 14</li> <li>CE Marked (EN/IEC 60947-5-1, EN/IEC 60947-5-5, EN ISO 13850)</li> </ul>

## Contact Ratings

Use the following tables to verify that the ratings meet the needs of your applications.

### Standard Contacts

- Minimum: 24V, 24 mA
- Maximum thermal continuous current  $I_{th}$  10 A AC/2.5 A DC.

Bulletin 800T units with 800T-XA contacts have the following ratings:

Max Operational Volts $U_e$	Utilization Category		Rated Operating Currents		
	IEC	NEMA	Volts $U_e$	Make	Break
AC 600	AC-15	A600	120...600	7200VA	720VA
			72...120	60 A	720VA
			24...72	60 A	10 A
DC 600	DC-13	Q600	28...600	69VA	
			24...28 <sup>(1)</sup>	2.5 A	

(1) For applications below 17V/5 mA, PenTUFF or Logic Reed contacts are recommended.

Electrical design lifecycles: 1,000,000 (at max rated load)

## Explosion-protected Contacts

- Maximum thermal continuous current  $I_{th}$  = 10 A
- Minimum low-energy switching load: 17V DC, 5 mA
- Electrical design lifecycles: 1,000,000 (24V DC, 25 mA)
- Vibration: 5 g, 0.7 mm peak-to-peak displacement, sine sweep 10...2000 Hz / IEC 60068-2-6
- Shock: 15 g (800H-TFRX\_ trigger action E-stops), 50 g (all other devices) / IEC 60068-2-27

Bulletin 800T units with 800TC-XAF contacts have the following ratings:

Max Operational Volts $U_e$	Utilization Category		Rated Operating Currents		
	IEC	NEMA	Volts $U_e$	Make	Break
AC 600	AC-15	A600	120...600	7200VA	720VA
			72...120	60 A	720VA
			24...72	60 A	10 A
DC 600	DC-13	P300	24...300	138VA	
			0...24	5.0 A	
		Q600	28...600	69VA	
			24...28	2.5 A	

## Sealed Switch Contacts

- Minimum: 5V, 1 mA
- Maximum continuous current  $I_{th}$  5 A.

Bulletin 800T units with sealed switch contact blocks have the following ratings:

Max Operational Volts $U_e$	Utilization Category		Rated Operating Currents		
	IEC	NEMA	Volts $U_e$	Make	Break
AC 600	AC-15	B600	120...600	3600VA	360VA
			0...120	30 A	3 A
DC 300	DC-13	P300	24...300	138VA	
			0...24	5.0 A	

## Stackable Sealed Switch Contacts

### Series A

- Minimum: 5V, 10 mA (digital); 24V, 1 mA (analog)
- Maximum continuous current  $I_{th}$  2.5 A.

Bulletin 800T units with stackable sealed switch contact blocks have the following ratings:

Max Operational Volts $U_e$	Utilization Category		Rated Operating Currents		
	IEC	NEMA	Volts $U_e$	Make	Break
AC 300	AC-15	C300	120...300 0...120	1800VA 15 A	180VA 1.5 A
DC 150	DC-13	Q150	24...150 0...24	69VA 2.5 A	

### Series B

- Minimum: 5V, 10 mA (digital); 24V, 1 mA (analog)
- Maximum continuous current  $I_{th}$  5.0 A.
- Electrical design lifecycles: 1,000,000 min.
- Vibration: 5 g, 0.5 mm peak-to-peak displacement, sine sweep 10...2000 Hz / IEC 60068-2-6
- Shock: 20 g / IEC 60068-2-27

Max Operational Volts $U_e$	Utilization Category		Rated Operating Current (A)				Volt-Amp Rating	
			120V		240V			
	IEC	NEMA	Make	Break	Make	Break	Make	Break
AC 300	AC-15	B300	30	3	15	1.5	3600	360
DC 150	DC-13	Q150	24...150V				69	
			0...24V				2.5 A	

## Logic Reed Contacts

- Minimum – DC: 5V, 1 mA
- Maximum – DC: 30V, 0.06 A, AC: 150V, 0.15 A
- Only used with resistive loads.
- Electrical design lifecycles: 200,000 (at max rated load)

## PenTUFF (Low Voltage) Contacts

- Minimum DC: 5V, 1 mA
- Maximum thermal continuous current  $I_{th}$  2.5 A AC/1.0 A DC.

Bulletin 800T units with 800T-XAV contacts have the following ratings:

Max Operational Volts $U_e$	Utilization Category		Rated Operating Currents		
	IEC	NEMA	Volts $U_e$	Make	Break
AC 300	AC-15	C300	120...300 0...120	1800VA 15 A	180VA 1.5 A
DC 150	DC-13	R150	24...150 0...24	28VA 1.0 A	

## Snap Action Contacts

Bulletin 800T units with snap action contact blocks have the following ratings:

Max Operational Volts $U_e$	Contact Rating Designation	Rated Operating Currents		
		Volts $U_e$	Make	Break
AC 300	A300	120...300 24...72	7200VA 60 A	720VA 10 A
DC 250	—	230...250 115...125	0.2 A 0.4 A	

## MaxDuty Contact Ratings

- Maximum thermal continuous current  $I_{th}$  24 A.
- Pilot Duty – 120V AC, 12 A; 24V DC, 10 A
- Motor Ratings – 120V AC, 1.5 Hp; 240V AC, 3 Hp; 24V DC, 10 A FLA/60 A LRA

## Time Delay Contacts

**IMPORTANT** This device is not rated for DC applications.

Bulletin 800T units with time delay contact blocks have the following ratings:

Max Operational Volts $U_e$	Contact Rating Designation	Rated Operating Currents		
		Volts $U_e$	Make	Break
AC 120	B150	120	3600VA	360VA

Adjustment range: 0.5...15 s  $\pm$  25%  $I_{th}$  = 5 A

## Assembled Stations

Our 30 mm assembled stations are available in die-cast aluminum, stainless steel, glass, and thermoplastic polyester resin construction. These stations come completely assembled for easy installation or they can be custom-built to fit your needs (see [page 37](#)).



Die Cast Aluminum  
Cat. No. 800T-2TAR



Booted Operator - Stainless Steel  
Cat. No. 800H-1HA4T



Booted Operator - Glass Polyester  
Cat. No. 800H-1HA4R

Operator	Contact Symbol	Contact Action	Button Type	Button Color	Legend Marking	Type 4/13			
						Die Cast Aluminum	Booted Operator - Stainless Steel	Booted Operator - Glass Polyester	
						Cat. No.	Cat. No. (1)	Cat. No. (1)	
One push button		1 N.O. - 1 N.C.	Momentary	Extended	Red	STOP	800T-1TA	800H-1HA4T	800H-1HA4R
			Momentary	Flush	Green	START	800T-1TB	800H-1HB4T	800H-1HB4R
			Momentary	Flush	Black	No legend	800T-1TX	800H-1HX4T	800H-1HX4R
Two push buttons		1 N.O. - 1 N.C. each button	Momentary	Flush Extended	Green Red	START STOP	800T-2TA	800H-2HA4T	800H-2HA4R
			Momentary	Flush Flush	Black Black	No legend	800T-2TX	800H-2HX4T	800H-2HX4R
One pilot light, two push buttons		1 N.O. - 1 N.C. each button	Momentary	120V AC Flush Extended	Red Green Red	No legend START STOP	800T-2TAR	800H-2HAR4T	800H-2HAR4R
			Momentary	120V AC Flush Flush	Red Black Black	No legend	800T-2TXR	800H-2HXR4T	800H-2HXR4R
3-position selector switch		1 N.O. - 1 N.C.	Maintained	Knob lever	Black with white insert	HAND-OFF-AUTO	800T-R3TA	—	—
			Maintained	Knob lever	Black with white insert	No legend	800T-R3TX	—	—
One push button		1 N.C.L.B.	Maintained	Push-pull/Twist	Red	EMERG STOP	800T-1TYM (2)	—	—
Two push buttons		1 N.O. - 1 N.C.	Maintained	Flush Extended	Green Red	START STOP	800T-2TAM	800H-2HAM4T	800H-2HAM4R
			Maintained	Flush Flush	Black Black	No legend	800T-2TXM	800H-2HXM4T	800H-2HXM4R

(1) Boot material is chlorosulfonated polyethylene. Add suffix L to the cat. no. for station with bootless operators. Example: Cat. No. 800H-1HB4T becomes Cat. No. 800H-1HB4TL.

(2) Supplied with yellow legend plate to comply with IEC 60947-5-5 and NFPA79 E-stop standards that require yellow background.

# Emergency Stop Devices (Trigger Action)

Our E-stops devices are tamper-resistant featuring front-of-panel mounting and nonremovable operator heads. They are also compliant with global E-stop standards, including EN ISO 13850 and EN 60947-5-5. All push buttons are red, 2-position with twist-to-release trigger action. They are available in non-illuminated and illuminated versions.

## 2-position – Non-illuminated



Cat. No. 800T-TFXJET6



Cat. No. 800T-TFXLET6



Cat. No. 800T-TFXK6



Cat. No. 800H-TFRXT6

800      T        -        TFX        T        6        D2    
           a            b            c            d            e

a	
Protection Rating	
Code	Description
T	Metal, Type 4/13
H	Plastic, Type 4/4X/13

b	
Fingersafe Guards	
Code	Description
Blank	No guards
C	Guard on terminals

c		
Head Type		
800T Code	Description	800H Code
TFX	Standard (45 mm) mushroom head	TFRX
TFXJ	Jumbo (60 mm) mushroom head	TFRXJ
TFXJE	Jumbo (60 mm) mushroom head with "E-stop" <sup>(1)</sup>	TFRXJE
TFXK	45 mm mushroom head key release	—
TFXL	63 mm anodized aluminum head	—
TFXLE	63 mm anodized aluminum head with "E-stop" <sup>(1)</sup>	—

(1) "E-stop" on the mushroom head does not comply with EN ISO 13850.

d	
Release Function	
Code	Description
Blank	Key release <sup>(1)</sup> (2)
T	Twist release

e			
Contact Blocks			
Code	Operator Position		Description
	Out	In	
Blank	—	—	No contacts on operator
Standard			
D2	X	0	1 N.C.
A	0 X	X 0	1 N.O. - 1 N.C.
A4	X X	0 0	2 N.C.
PentUFF™ (Low Voltage)			
D2V	X	0	1 N.C.
AV	0 X	X 0	1 N.O. - 1 N.C.

X = Closed/0 = Open

e (cont'd)			
Contact Blocks			
Code	Operator Position		Description
	Out	In	
Class I, Div 2 – Explosion-protected			
AF	0 X	X 0	1 N.O. - 1 N.C.
BF	0 X 0 X	X 0 0 X	2 N.O. - 2 N.C.

X = Closed/0 = Open

- (1) Configurable only with FXK head type.
- (2) Provided with two D018 keys.

## 2-position – Illuminated

- Light-emitting diode (LED) illumination is provided as standard



Cat. No. 800T-TFXTS00R



Cat. No. 800T-TFXJETS00R



Cat. No. 800H-TFRXTS00R



Cat. No. 800H-TFRXJETS00R

**800**   **T**   **-**   **TFXT**   **QH**   **2**   **R**   **A**  
           a           b           c           d           e           f

a	
Protection Rating	
Code	Description
T	Metal, Type 4/13
H	Plastic, Type 4/4X/13

b	
Fingersafe Guards	
Code	Description
Blank	No guards
C	Guard on terminals

c		
Head Type		
800T Code	Description	800H Code
TFXT	Standard (45 mm) mushroom head	TFRXT
TFXJT	Jumbo (60 mm) mushroom head	TFRXJT
TFXJET	Jumbo (60 mm) mushroom head with "E-stop" <sup>(1)</sup>	TFRXJET

(1) "E-stop" on the mushroom head does not comply with EN ISO 13850.

d	
Illumination Option	
Code	Description
PH	Transformer with LED lamp
QH	Full voltage with LED lamp
S	Operator only

e	
Voltage	
Code	Description
Transformer	
16	120V AC, 50/60 Hz
26	240V AC, 50/60 Hz
46	480V AC, 50/60 Hz
56	600V AC, 50/60 Hz
Full Voltage	
2	12...130V AC/DC
Operator Only	
00	No power module

f		
Target		
Contact		
N.O.	0	X
N.C./ N.C.L.B./ S.M.C.B.	X	0
Contact Blocks		
Code	Description	
Blank	No contacts	
Standard		
D2	1 N.C.	
D4S	1 S.M.C.B.	
A	1 N.O. - 1 N.C.	
G1	2 N.O. - 2 N.C.	
PenTUFF (Low Voltage)		
D2V	1 N.C.	
AV	1 N.O. - 1 N.C.	
G1V	2 N.O. - 2 N.C.	
Class I, Div 2 – Explosion-protected		
AF	1 N.O. - 1 N.C.	
G1F	2 N.O. - 2 N.C.	

X = Closed/O = Open



## Momentary Contact Devices – Non-illuminated



Flush Head Unit  
Cat. No. 800T-A1A



Extended Head Unit  
Cat. No. 800T-B6A



Booted Unit  
Cat. No. 800H-R2A



Bootless Flush Head Unit  
Cat. No. 800H-AR1A

800 T - A 1 A  
a b c d e f

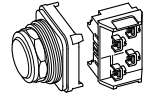

a	
Protection Rating	
Code	Description
T	Metal, Type 4/13
H	Plastic, Type 4/4X/13

b	
Fingersafe Guards	
Code	Description
Blank	No guards
C	Guard on terminals

c		
Operator Type		
800T Code	Description	800H Code
A	Flush head	AR
B	Extended head	BR
D	Mushroom head	DR
DX	Mushroom head (no color cap)	DRX
–	Bootless guarded head	GR
–	Booted head	R <sup>(2)</sup>

d	
Color Cap	
Code	Description
Blank	Used only when Operator Type DX/DRX is ordered
1	Green
2	Black
3	Orange <sup>(1)</sup>
4	Gray <sup>(1)</sup>
5	White <sup>(1)</sup>
6	Red
7	Blue
9	Yellow

(1) Not available for booted operators.

(2) Underlying operators are extended head. Boot material is chlorosulfonated polyethylene.

e	
Special Mushroom Head	
Code	Description
J	Jumbo mushroom head (plastic)
L <sup>(1)</sup>	Jumbo mushroom head (metal)

**Note:** Special mushroom head options only apply to mushroom head operator type code D/DR (Table c).

f	
Contact Blocks	
Code	Description
Blank	No contacts
Standard	
D1	1 N.O.
D2	1 N.C.
D3	1 N.O.E.M.
D4	1 N.C.L.B.
D5	1 N.O. (Mini)
D6	1 N.C. (Mini)
A1	1 N.C.L.B. - 1 N.O.
A2	2 N.O. <sup>(2)</sup>
A4	2 N.C.
A7	1 N.C.L.B. - 1 N.C.
A	1 N.O. - 1 N.C.
B	2 N.O. - 2 N.C.

f (cont'd)	
Contact Blocks	
Code	Description
PentUFF™ (Low Voltage)	
D1V	1 N.O.
D2V	1 N.C.
D3V	1 N.O.E.M.
D4V	1 N.C.L.B.
AV	1 N.O. - 1 N.C.
BV	2 N.O. - 2 N.C.
Time Delay	
T	1 N.O. Depress close, delayed opening
S	1 N.C. Depress open, delayed closure
Snap Action <sup>(3)</sup>	
M	1 N.O. - 1 N.C.
N	2 N.O. - 2 N.C.

f (cont'd)	
Contact Blocks	
Code	Description
Class I, Div. 2 – Explosion-protected	
AF	1 N.O. - 1 N.C.
BF	2 N.O. - 2 N.C.
Class I, Div. 2 – Logic Reed	
D1R	1 N.O.
D2R	1 N.C.
A2R	2 N.O. <sup>(2)</sup>
A4R	2 N.C.
AR	1 N.O. - 1 N.C.
BR	2 N.O. - 2 N.C.
Class I, Div. 2 – Stackable Sealed Switch	
D1Y	1 N.O.
D2Y	1 N.C.
AY	1 N.O. - 1 N.C.
BY	2 N.O. - 2 N.C.

Time Delay Contacts
Series C field installable kits can only be used with Series T or later operators. Adjustable range of 0.5...15 s + 25%. Maximum continuous current $I_{th}$ 5 A.

Snap Action Contacts
Snap-action contacts feature a quick make, quick break snap-action mechanism that is only available on factory-assembled units. Maximum continuous current $I_{th}$ 10 A.

(1) Jumbo mushroom head (metal) is only available in colors green, black, red, and yellow.

(2) A2 and A2R contact blocks cannot be stacked upon, but can stack on other contact blocks.

(3) Snap action contact blocks only available with flush and extended head operators in the colors green, black, or red.

# Momentary Contact Devices – Illuminated



Extended Head Without Guard  
Cat. No. 800T-PB16R



Extended Head without Guard  
Cat. No. 800H-PRB16R

800 T - P B H 16 R  
a b c d e f g h

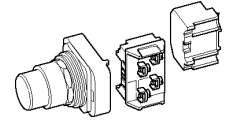

a	
Protection Rating	
Code	Description
T	Metal, Type 4/13
H	Plastic, Type 4/4X/13

b	
Fingersafe Guards	
Code	Description
Blank	No guards
C	Guard on terminals

c		
Power Module Type		
800T Code	Description	800H Code
P	Transformer (or dual input)	PR
Q	Full voltage	QR
S	Operator only <sup>(2)</sup>	—

d	
Head Type	
Code	Description
A	Extended head with guard
B	Extended head without guard
M	Mushroom <sup>(1)</sup>
MJ	Jumbo mushroom <sup>(1)</sup>

(1) Mushroom and jumbo mushroom head not available in yellow.  
(2) Operator only supplied without power module, lamp, lens cap, or contact blocks.

e	
Illumination Options	
Code	Description
Blank	Incandescent
H	LED
Dual Input	
D	Diode type <sup>(1)</sup>
T	Transformer – relay type <sup>(2)</sup>
TH	Transformer – relay type LED <sup>(2)</sup>

f	
Voltage	
Code	Description
Transformer	
16	120V AC, 50/60 Hz
26	240V AC, 50/60 Hz
46	480V AC, 50/60 Hz
56	600V AC, 50/60 Hz
Full Voltage – Incandescent	
12	12V AC/DC
24	24V AC/DC
48	48V AC/DC
10	120V AC/DC
20	240V AC/DC
Full Voltage – LED	
2	12...130V AC/DC
Dual Input	
16	120V AC
24	24V AC/DC <sup>(3)</sup>
Operator Only	
00	No power module

g	
Lens Color	
Code	Description
Blank	No lens with standard contacts 1 N.O. - 1 N.C.
X	No lens if any contacts other than standard 1 N.O. - 1 N.C. is ordered.
A	Amber
B	Blue
C	Clear
G	Green
R	Red
W	White
Y	Yellow

h	
Contact Blocks	
Code	Description
X	No contacts
Standard	
Blank	1 N.O. - 1 N.C.
D1	1 N.O.
PenTUFF (Low Voltage)	
AV	1 N.O. - 1 N.C.
Class I, Div. 2 - Explosion-protected	
AF	1 N.O. - 1 N.C.
Class I, Div. 2 - Logic Reed	
AR	1 N.O. - 1 N.C.
Class I, Div. 2 - Stackable Sealed Switch	
AY	1 N.O. - 1 N.C.

(1) Diode type dual input provides circuit isolation via opposing diodes. Not recommended for use with solid-state outputs.  
(2) Dual input (transformer relay type) is not configurable with Class I Div. 2 contact blocks.  
(3) Dual-input diode only.

# Momentary Contact Devices with Two-color Molded Legend Caps – Non-illuminated



Cat. No. 800T-A00 with  
Cat. No. 800T-LC103W installed



Cat. No. 800H-BR00 with  
Cat. No. 800T-LC604 installed

800    T                    -                    A                    103W                    A  
          a                    b                    c                    d                    e

a	
Protection Rating	
Code	Description
T	Metal, Type 4/13
H	Plastic, Type 4/4X/13

b	
Fingersafe Guards	
Code	Description
Blank	No guards
C	Guard on terminals

c		
Operator Type		
800T Code	Description	800H Code
A	Flush head	AR
B	Extended head	BR

d			
Cap Text/Color			
Code	Text	Color	
		Cap	Text
101W	I	Green	White
103W	START		
105W	ON		
121W	START / I		
202W	O	Black	White
204W	STOP		
207W	RESET		
208W	↑		
209W	FORWARD		
210W	REVERSE		
212W	JOG		
213W	UP		
214W	DOWN		
215W	RAISE		
216W	LOWER		
217W	IN		
218W	OUT		
219W	HIGH		
220W	LOW		
222W	STOP / O		
501B	I	White	Black
503B	START		
508B	↑		
521B	START / I		
602W	O	Red	White
604W	STOP		
606W	OFF		
622W	STOP / O		
707W	RESET	Blue	White
711W	R		

e	
Contact Blocks	
Code	Description
Blank	No contacts
Standard	
D1	1 N.O.
D2	1 N.C.
D3	1 N.O.E.M.
D4	1 N.C.L.B.
D5	1 N.O. (Mini)
D6	1 N.C. (Mini)
A1	1 N.C.L.B. - 1 N.O.
A2	2 N.O. <sup>(1)</sup>
A4	2 N.C.
A7	1 N.C.L.B. - 1 N.C.
A	1 N.O. - 1 N.C.
B	2 N.O. - 2 N.C.
PenTUFF (Low Voltage)	
D1V	1 N.O.
D2V	1 N.C.
D3V	1 N.O.E.M.
D4V	1 N.C.L.B.
AV	1 N.O. - 1 N.C.
BV	2 N.O. - 2 N.C.

e (cont'd)	
Contact Blocks	
Code	Description
Class I, Div. 2 - Explosion-protected	
AF	1 N.O. - 1 N.C.
BF	2 N.O. - 2 N.C.
Class I, Div. 2 - Logic Reed	
D1R	1 N.O.
D2R	1 N.C.
A2R	2 N.O. <sup>(1)</sup>
A4R	2 N.C.
AR	1 N.O. - 1 N.C.
BR	2 N.O. - 2 N.C.
Class I, Div. 2 - Stackable Sealed Switch	
D1Y	1 N.O.
D2Y	1 N.C.
AY	1 N.O. - 1 N.C.
BY	2 N.O. - 2 N.C.

(1) A2 and A2R contact blocks cannot be stacked upon, but can stack upon other contact blocks.

## Operator Only

Button Type	Type 4/13	Type 4/4X/13
	Cat. No. <sup>(1)</sup>	Cat. No.
Flush	800T-A00	800H-AR00
Extended	800T-B00	800H-BR00

(1) Operator only devices are supplied with no legend cap or contact blocks.

## Legend Caps

Text	Cap Color	Text Color	Pkg Qty	Cat. No.
	Green	White	1	800T-LC101W
START				800T-LC103W
ON				800T-LC105W
START /				800T-LC121W
0				800T-LC202W
STOP	800T-LC204W			
RESET	800T-LC207W			
↑	800T-LC208W			
FORWARD	800T-LC209W			
REVERSE	800T-LC210W			
JOG	800T-LC212W			
UP	800T-LC213W			
DOWN	800T-LC214W			
RAISE	800T-LC215W			
LOWER	800T-LC216W			

Text	Cap Color	Text Color	Pkg Qty	Cat. No.
IN	Black	White	1	800T-LC217W
OUT				800T-LC218W
HIGH				800T-LC219W
LOW				800T-LC220W
STOP / 0				800T-LC222W
	White	Black		800T-LC501B
START				800T-LC503B
↑				800T-LC508B
START /				800T-LC521B
0	Red	White		800T-LC602W
STOP				800T-LC604W
OFF				800T-LC606W
STOP / 0				800T-LC622W
RESET	Blue	White		800T-LC707W
R				800T-LC711W

## Contact Blocks

See [Contact Blocks on page 39](#) for a complete listing.

## 2-position – Non-illuminated



Standard Knob Operator  
Cat. No. 800T-H2A



Knob Lever Operator  
Cat. No. 800T-H17A



Standard Knob Operator  
Cat. No. 800H-HR2A

800    T                    -    HA    2            A  
          a                    b                    c                    d                    e

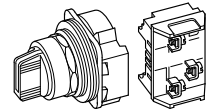

a	
Protection Rating	
Code	Description
T	Metal, Type 4/13
H	Plastic, Type 4/4X/13

b	
Fingersafe Guards	
Code	Description
Blank	No guards
C	Guard on terminals

c		
Knob Insert Colors		
800T Code	Description	800H Code
H	White	HR
HX	Packet of colored inserts <sup>(1)</sup>	HRX
Metal Wing Lever Colors		
HA	Red	—
HG	Gray	—

(1) One insert of each color (blue, green, orange, red, and yellow).

d	
Operator Type and Function	
Code	Operator Function
Standard Knob	
2	Maintained
4	Spring return from left <sup>(1)</sup>
5	Spring return from right
Knob Lever <sup>(2)</sup>	
17	Maintained
18	Spring return from left <sup>(1)</sup>
19	Spring return from right
Metal Wing Lever <sup>(2)</sup>	
11	Maintained
15	Spring return from left <sup>(1)</sup>
16	Spring return from right
Coin Slot <sup>(2)</sup>	
6	Maintained
7	Spring return from left
8	Spring return from right

e			
Contact Blocks			
Code	Contact Configuration	2-position	
Blank	No contacts	—	—
Standard			
D1	1 N.O.	O	X
D2	1 N.C.	X	O
A	1 N.O. - 1 N.C.	O	X
		X	O
B	2 N.O. - 2 N.C.	O	X
		X	O
		O	X
Code	Description		
	MaxDuty (Horsepower Rated) <sup>(3)</sup>		
D1M	1 N.O.		
D2M	1 N.C.		
PentUFF™ (Low Voltage) <sup>(3)</sup>			
D1V	1 N.O.		
D2V	1 N.C.		
AV	1 N.O. - 1 N.C.		
BV	2 N.O. - 2 N.C.		

e (cont'd)	
Contact Blocks	
Code	Description
Class I, Div. 2 - Explosion-protected <sup>(3)</sup>	
AF	1 N.O. - 1 N.C.
BF	2 N.O. - 2 N.C.
Class I, Div. 2 - Logic Reed <sup>(3)</sup>	
D1R	1 N.O.
D2R	1 N.C.
AR	1 N.O. - 1 N.C.
BR	2 N.O. - 2 N.C.
Class I, Div. 2 - Stackable Sealed Switch <sup>(3)</sup>	
D1Y	1 N.O.
D2Y	1 N.C.
AY	1 N.O. - 1 N.C.
BY	2 N.O. - 2 N.C.

(1) Target tables are reversed from what is shown in Table e.

(2) Only available on Bulletin 800T, Type 4/13 operators.

(3) Contact target tables are the same as standard contact blocks.

# 2-position Cylinder Lock (Bulletin 800T Only) – Non-illuminated



2-position Cylinder Lock Operator  
Cat. No. 800T-H33A

**800**    **T**            **-**    **H31**            **A**  
                 a                b                c                d                e

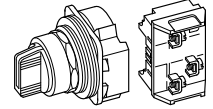

a	
Protection Rating	
Code	Description
T	Metal, Type 4/13

b	
Fingersafe Guards	
Code	Description
Blank	No guards
C	Guard on terminals

c	
Key Removal Position <sup>(1)</sup>	
Code	Operator Function
<b>Maintained</b>	
H31	Key removal – left
H32	Key removal – right
H33	Key removal – both
<b>Spring Return from Left</b>	
H42	Key removal – right <sup>(2)</sup>
<b>Spring Return from Right</b>	
H48	Key removal – left

- (1) Keys removable from maintained positions only.
- (2) Target tables are reversed from what is shown in Table e.

d			
Key Options for Cylinder Locks <sup>(1)</sup>			
Code	T Series Key No.	Code	T Series Key No.
Blank	D018 (std. key)	15	T112
03	D020	16	T115
04	D025	17	T324
05	D335	18	T382
06	D429	19	T404
07	D461	20	T171
08	D111	21	T484
09	D587	22	T547
10	D682	23	T569
11	D713	24	T692
12	D900	25	T752
13	D992	26	T178
14	D118		

e			
Contact Blocks			
Code	Contact Configuration	2-position	
Blank	No contacts	–	–
Standard			
D1	1 N.O.	O	X
D2	1 N.C.	X	O
A	1 N.O. - 1 N.C.	O	X
		X	O
B	2 N.O. - 2 N.C.	O	X
		X	O
		O	X
X	O		
Code	Description		
MaxDuty (Horsepower Rated) <sup>(2)</sup>			
D1M	1 N.O.		
D2M	1 N.C.		
PentUFF (Low Voltage) <sup>(2)</sup>			
D1V	1 N.O.		
D2V	1 N.C.		
AV	1 N.O. - 1 N.C.		
BV	2 N.O. - 2 N.C.		

e (cont'd)	
Contact Blocks	
Code	Description
<b>Class I, Div. 2 - Explosion-protected <sup>(2)</sup></b>	
AF	1 N.O. - 1 N.C.
BF	2 N.O. - 2 N.C.
<b>Class I, Div. 2 - Logic Reed <sup>(2)</sup></b>	
D1R	1 N.O.
D2R	1 N.C.
AR	1 N.O. - 1 N.C.
BR	2 N.O. - 2 N.C.
<b>Class I, Div. 2 - Stackable Sealed Switch <sup>(2)</sup></b>	
D1Y	1 N.O.
D2Y	1 N.C.
AY	1 N.O. - 1 N.C.
BY	2 N.O. - 2 N.C.

- (1) Device is supplied with two keys. Replacement key part no. for standard D018 key is X-181170. See [page 54](#) for additional replacement key numbers.
- (2) Contact target tables are the same as standard contact blocks.

# 3-position – Non-illuminated



Standard Knob Operator  
Cat. No. 800T-J2A



Knob Lever Operator  
Cat. No. 800T-J17A



Standard Knob Operator  
Cat. No. 800H-JR2A

800    T                    -    J    2                    C  
          a                    b                    c                    d                    e                    f

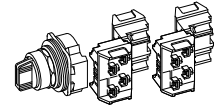

a	
Protection Rating	
Code	Description
T	Metal, Type 4/13
H	Plastic, Type 4/4X/13

b	
Fingersafe Guards	
Code	Description
Blank	No guards
C	Guard on terminals

c		
Knob Insert Colors		
800T Code	Description	800H Code
J	White	JR
JX	Packet of colored inserts <sup>(1)</sup>	JRX
Metal Wing Lever Colors		
JA	Red	–
JG	Gray	–

(1) One insert of each color (blue, green, orange, red, and yellow).

d	
Operator Type and Function	
Code	Operator Function
Standard Knob	
2	Maintained
4	Spring return from left
5	Spring return from right
91	Spring return from both
Knob Lever <sup>(2) (3)</sup>	
17	Maintained
18	Spring return from left
19	Spring return from right
20	Spring return from both
Metal Wing Lever <sup>(2) (3)</sup>	
11	Maintained
15	Spring return from left
16	Spring return from right
141	Spring return from both
Coin Slot <sup>(2) (3)</sup>	
6	Maintained
7	Spring return from left
8	Spring return from right
10	Spring return from both

e	
Cam Options <sup>(1) (2)</sup>	
Code	Description
Blank	KB7 cam (std.)
KA1	KA1 cam
KA7	KA7 cam
KC1	KC1 cam
KC7	KC7 cam
KD7	KD7 cam
KE7	KE7 cam <sup>(4)</sup>
KQ1	KQ1 cam
KQ7	KQ7 cam
KR1	KR1 cam <sup>(4)</sup>
KR7	KR7 cam <sup>(4)</sup>
KT1	KT1 cam <sup>(4)</sup>
KT7	KT7 cam <sup>(4)</sup>
KU7	KU7 cam <sup>(4)</sup>

f	
Contact Blocks <sup>(1)</sup>	
Code	Description
Blank	No contacts on operator
Standard	
A	1 N.O. - 1 N.C. One <b>800T-XA</b> on white side
B	2 N.O. - 2 N.C. Two <b>800T-XAs</b> – 1 on white side/1 on black side
PenTUFF (Low Voltage)	
AV	1 N.O. - 1 N.C. One <b>800T-XAV</b> on white side
BV	2 N.O. - 2 N.C. Two <b>800T-XAVs</b> – 1 on white side/1 on black side
Class I, Div. 2 - Logic Reed	
AR	1 N.O. - 1 N.C. One <b>800T-XAR</b> on white side
BR	2 N.O. - 2 N.C. Two <b>800T-XARs</b> – 1 on white side/1 on black side

f (cont'd)	
Contact Blocks <sup>(1)</sup>	
Code	Description
Class I, Div. 2 - Explosion-protected	
AF	1 N.O. - 1 N.C. One <b>800TC-XAF</b> on white side
BF	2 N.O. - 2 N.C. Two <b>800TC-XAFs</b> – 1 on white side/1 on black side
Class I, Div. 2 - Stackable Sealed Switch	
AY	1 N.O. - 1 N.C. One <b>800TC-XAY</b> on white side
BY	2 N.O. - 2 N.C. Two <b>800TC-XAYs</b> – 1 on white side/1 on black side

(1) See [Table 5 on page 19](#) for cam selections and associated targets.  
 (2) If an overlapping cam is required, consult your local distributor.  
 (3) Only available on Bulletin 800T, Type 4/13 operators.  
 (4) Not available with wing levers.

# 3-position Cylinder Lock (Bulletin 800T Only) – Non-illuminated



3-position Cylinder Lock Operator  
Cat. No. 800T-J41A

800    T                    -    J41                    KC1                    A  
          a                    b                    c                    d                    e                    f

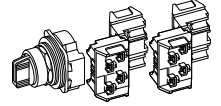

a	
Protection Rating	
Code	Description
T	Metal, Type 4/13

b	
Fingersafe Guards	
Code	Description
Blank	No guards
C	Guard on terminals

c	
Key Removal Position	
Code	Operator Function
<b>Maintained</b>	
J41	Key removal – left
J42	Key removal – center
J43	Key removal – right
J44	Key removal – all
J45	Key removal – left and center
J46	Key removal – right and left
J47	Key removal – right and center

c (cont'd)	
Key Removal Position	
Code	Operator Function
<b>Spring Return from Left</b>	
J50	Key removal – center
J52	Key removal – right
J51	Key removal – right and center
<b>Spring Return from Right</b>	
J69	Key removal – left
J38	Key removal – center
J73	Key removal – left and center
<b>Spring Return from Both</b>	
J631	Key removal – center

d			
Key Options for Cylinder Locks <sup>(1)</sup>			
Code	T Series Key No.	Code	T Series Key No.
Blank	D018 (std. key)	15	T112
03	D020	16	T115
04	D025	17	T324
05	D335	18	T382
06	D429	19	T404
07	D461	20	T171
08	D111	21	T484
09	D587	22	T547
10	D682	23	T569
11	D713	24	T692
12	D900	25	T752
13	D992	26	T178
14	D118		

e	
Cam Options <sup>(2) (3)</sup>	
Code	Description
Blank	KB7 cam (std.)
KA1	KA1 cam
KA7	KA7 cam
KC1	KC1 cam
KC7	KC7 cam
KD7	KD7 cam
KE7	KE7 cam
KQ1	KQ1 cam
KQ7	KQ7 cam
KR1	KR1 cam
KR7	KR7 cam
KT1	KT1 cam
KT7	KT7 cam
KU7	KU7 cam

f	
Contact Blocks <sup>(3)</sup>	
Code	Contact Configuration
Blank	No contacts
<b>Standard</b>	
A	1 N.O. - 1 N.C. One <b>800T-XA</b> on white side
B	2 N.O. - 2 N.C. Two <b>800T-XAs</b> – 1 on white side/1 on black side
<b>PenTUFF (Low Voltage)</b>	
AV	1 N.O. - 1 N.C. One <b>800T-XAV</b> on white side
BV	2 N.O. - 2 N.C. Two <b>800T-XAVs</b> – 1 on white side/1 on black side
<b>Class I, Div. 2 - Logic Reed</b>	
AR	1 N.O. - 1 N.C. One <b>800T-XAR</b> on white side
BR	2 N.O. - 2 N.C. Two <b>800T-XARs</b> – 1 on white side/1 on black side

f (cont'd)	
Contact Blocks <sup>(3)</sup>	
Code	Contact Configuration
<b>Class I, Div. 2 - Explosion-protected</b>	
AF	1 N.O. - 1 N.C. One <b>800TC-XAF</b> on white side
BF	2 N.O. - 2 N.C. Two <b>800TC-XAFs</b> – 1 on white side/1 on black side
<b>Class I, Div. 2 - Stackable Sealed Switch</b>	
AY	1 N.O. - 1 N.C. One <b>800T-XAY</b> on white side
BY	2 N.O. - 2 N.C. Two <b>800T-XAYs</b> – 1 on white side/1 on black side

(1) Device is supplied with two keys. Replacement key part no. for standard D018 key is X-181170. Consult your local distributor for additional replacement key numbers.  
 (2) If an overlapping cam is required, consult your local distributor.  
 (3) See [Table 5 on page 19](#) for cam selections and associated targets.



# 4-position – Non-illuminated



Standard Knob Operator  
Cat. No. 800T-N2KN4B



Knob Lever Operator  
Cat. No. 800T-N17KN4B



Standard Knob Operator  
Cat. No. 800H-NR2KF4AAXX

800    T       -       N       2       KF4    B  
         a       b       c       d       e       f

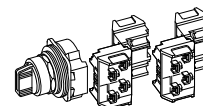

a	
Protection Rating	
Code	Description
T	Metal, Type 4/13
H	Plastic, Type 4/4X/13

b	
Fingersafe Guards	
Code	Description
Blank	No guards
C	Guard on terminals

c		
Knob Insert Colors		
800T Code	Description	800H Code
N	White	NR
NX	Packet of colored inserts <sup>(1)</sup>	NRX
Metal Wing Lever Colors		
NA	Red	—
NG	Gray	—

(1) One insert of each color (blue, green, orange, red, and yellow).

d	
Operator Type and Function	
Code	Operator Function
Standard Knob	
2	Maintained
3	Spring return from position 1 to position 2
9	Spring return from position 4 to position 3
Knob Lever <sup>(4)</sup>	
17	Maintained
29	Spring return from position 1 to position 2
30	Spring return from position 4 to position 3
Metal Wing Lever <sup>(4)</sup>	
11	Maintained
13	Spring return from position 1 to position 2
14	Spring return from position 4 to position 3

e	
Cam Options <sup>(1)</sup>	
Code	Description
KF4	F cam
KG4	G cam
KK4	K cam <sup>(2)</sup>
KM4	M cam <sup>(2)</sup>
KP4	P cam
KN4	Overlapping cam <sup>(3)</sup>

f	
Contact Blocks <sup>(1)</sup>	
Code	Contact Configuration
Blank	No contacts
Standard	
B	2 N.O. - 2 N.C. Two <b>800T-XA</b> s – 1 on white side/1 on black side
H	3 N.O. - 3 N.C. Three <b>800T-XA</b> s – 2 on white side/1 on black side
C	4 N.O. - 4 N.C. Four <b>800T-XA</b> s – 2 on white side/2 on black side

f (cont'd)	
Contact Blocks <sup>(1)</sup>	
Code	Contact Configuration
PenTUFF (Low Voltage)	
BV	2 N.O. - 2 N.C.
HV	3 N.O. - 3 N.C.
CV	4 N.O. - 4 N.C.
Class I, Div. 2 - Explosion-protected	
BF	2 N.O. - 2 N.C.
HF	3 N.O. - 3 N.C.
CF	4 N.O. - 4 N.C.
Class I, Div. 2 - Logic Reed	
BR	2 N.O. - 2 N.C.
HR	3 N.O. - 3 N.C.
CR	4 N.O. - 4 N.C.
Class I, Div. 2 - Stackable Sealed Switch	
BY	2 N.O. - 2 N.C.
HY	3 N.O. - 3 N.C.
CY	4 N.O. - 4 N.C.

(1) See [Table 6 on page 19](#) for cam selections and associated targets.  
 (2) Not available with wing levers.  
 (3) If an overlapping cam is required, consult your local distributor.  
 (4) Only available on Bulletin 800T, Type 4/13 operators.

# 4-position Cylinder Lock (Bulletin 800T Only) – Non-illuminated



4-position Cylinder Lock Operator  
Cat. No. 800T-N32KF4B

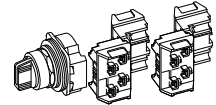

800    T                    -    N31                    KM4                    C  
          a                    b                    c                    d                    e                    f

a	
Protection Rating	
Code	Description
T	Metal, Type 4/13

b	
Fingersafe Guards	
Code	Description
Blank	No guards
C	Guard on terminals

c	
Key Removal Position	
Code	Operator Function
<b>Maintained</b>	
N31	Key removal position 1
N32	Key removal position 2
N33	Key removal position 3
N34	Key removal position 4
N61	Key removal all positions

c (cont'd)	
Key Removal Position	
Code	Operator Function
<b>Spring Return From Position 1 to Position 2</b>	
N132	Key removal position 2
N133	Key removal position 3
N134	Key removal position 4
N154	Key removal positions 2, 3, and 4
<b>Spring Return From Position 4 to Position 3</b>	
N231	Key removal position 1
N232	Key removal position 2
N233	Key removal position 3
N251	Key removal positions 1, 2, and 3

d			
Key Options for Cylinder Locks (1)			
Code	T Series Key No.	Code	T Series Key No.
Blank	D018 (std. key)	15	T112
03	D020	16	T115
04	D025	17	T324
05	D335	18	T382
06	D429	19	T404
07	D461	20	T171
08	D111	21	T484
09	D587	22	T547
10	D682	23	T569
11	D713	24	T692
12	D900	25	T752
13	D992	26	T178
14	D118		

e	
Cam Options (2)	
Code	Description
KF4	F cam
KG4	G cam
KK4	K cam
KM4	M cam
KP4	P cam
KN4	Overlapping cam (3)

f	
Contact Blocks (2)	
Code	Description
Blank	No contacts
<b>Standard</b>	
B	2 N.O. - 2 N.C. Two <b>800T-XA</b> s – 1 on white side/1 on black side
H	3 N.O. - 3 N.C. Three <b>800T-XA</b> s – 2 on white side/1 on black side
C	4 N.O. - 4 N.C. Four <b>800T-XA</b> s – 2 on white side/2 on black side
<b>PentTUFF (Low Voltage)</b>	
BV	2 N.O. - 2 N.C. Two <b>800T-XAV</b> s – 1 on white side/1 on black side
HV	3 N.O. - 3 N.C. Three <b>800T-XAV</b> s – 2 on white side/1 on black side
CV	4 N.O. - 4 N.C. Four <b>800T-XAV</b> s – 2 on white side/2 on black side

f (cont'd)	
Contact Blocks (2)	
Code	Description
<b>Class I, Div. 2 – Explosion-protected</b>	
BF	2 N.O. - 2 N.C.
HF	3 N.O. - 3 N.C.
CF	4 N.O. - 4 N.C.
<b>Class I, Div. 2 – Logic Reed</b>	
BR	2 N.O. - 2 N.C.
HR	3 N.O. - 3 N.C.
CR	4 N.O. - 4 N.C.
<b>Class I, Div. 2 – Stackable Sealed Switch</b>	
BY	2 N.O. - 2 N.C.
HY	3 N.O. - 3 N.C.
CY	4 N.O. - 4 N.C.

(1) Device is supplied with two keys. Replacement key part no. for standard D018 key is X-181170. Consult your local Allen-Bradley distributor for additional replacement key numbers.  
 (2) See [Table 6 on page 19](#) for cam selections and associated targets.  
 (3) If an overlapping cam is required, consult your local distributor.

# Cam Target Tables

Table 5 - 3-position Cam and Contact Block Functionality Table

Contact Block Suffix Code	Contact Block Side	Circuits	Cam Codes <sup>(1)</sup>																																	
			KB7 (Std.)	KA1	KA7	KC1	KC7	KD7	KE7	KQ1	KQ7	KR1	KR7	KT1	KT7	KU7																				
	White	A	X	0	0	X	0	0	0	0	X	0	0	X	0	0	X	0	0	X	0	X	0	X	0	X	0	0	X	0	0	X	0	0		
		B	0	0	X	0	X	0	0	0	X	0	0	0	X	0	0	X	0	0	X	0	0	X	0	0	X	0	0	X	0	0	X	0	0	
	Black	A	X	0	0	X	0	0	0	0	X	0	0	X	0	0	0	0	X	0	0	X	0	0	X	0	0	X	0	0	X	0	0	X	0	0
		B	0	0	X	0	X	0	0	0	X	0	0	0	X	0	0	X	0	0	X	0	0	X	0	0	X	0	0	X	0	0	X	0	0	
	White	A	X	0	0	X	0	0	0	0	X	0	0	X	0	0	0	X	0	0	X	0	0	X	0	0	X	0	0	X	0	0	X	0	0	
		B	0	0	X	0	X	0	0	0	X	0	0	0	X	0	0	X	0	0	X	0	0	X	0	0	X	0	0	X	0	0	X	0	0	
	Black	A	X	0	0	X	0	0	0	0	X	0	0	X	0	0	0	X	0	0	X	0	0	X	0	0	X	0	0	X	0	0	X	0	0	
		B	0	0	X	0	X	0	0	0	X	0	0	0	X	0	0	X	0	0	X	0	0	X	0	0	X	0	0	X	0	0	X	0	0	

(1) X = Closed, 0 = Open

Table 6 - 4-position Cam and Contact Block Functionality Table

Contact Block Suffix Code	Contact Block Side	Circuits	Cam Codes <sup>(1)</sup>																																
			KF4				KG4				KK4				KM4				KP4				KN4												
	White	A	X	0	0	0	X	X	0	0	0	0	X	X	X	0	0	0	0	0	0	X	0	0	0	0	0	0	0	X	0	X	0	0	
		B	0	X	0	0	0	0	0	X	0	X	X	0	0	0	X	X	0	0	0	X	0	0	0	0	X	0	0	0	X	0	0	0	X
	Black	A	0	0	0	X	X	0	0	0	X	0	0	X	0	0	0	0	X	0	0	X	0	0	X	0	0	X	0	0	X	0	0	X	0
		B	0	0	X	0	0	0	0	0	X	0	X	X	0	0	X	0	0	X	0	0	X	0	0	X	0	0	X	0	0	X	0	0	X
	White	A	X	0	0	0	X	X	0	0	0	0	X	X	X	0	0	0	0	0	0	X	0	0	X	0	0	X	0	0	X	0	0	X	0
		B	0	X	0	0	0	0	X	0	X	X	0	0	0	X	X	0	0	X	0	0	X	0	0	X	0	0	X	0	0	X	0	0	X
	Black	A	0	0	0	X	X	0	0	0	X	0	0	X	0	0	0	0	X	0	0	X	0	0	X	0	0	X	0	0	X	0	0	X	0
		B	0	0	X	0	0	0	0	0	X	0	X	X	0	0	X	0	0	X	0	0	X	0	0	X	0	0	X	0	0	X	0	0	X

(1) X = Closed, 0 = Open

# 2-position Knob/Lever Type – Illuminated



Standard Knob Operator  
Cat. No. 800T-16HR2KB6AX



Knob Lever Operator  
Cat. No. 800H-16HRR17KB6AX

800 T - 16 H R 2 KB6 A X  
a b c d e f g h i j

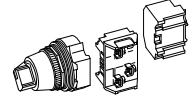

a	
Protection Rating	
Code	Description
T	Metal, Type 4/13
H	Plastic, Type 4/4X/13

b	
Fingersafe Guards	
Code	Description
Blank	No guards
C	Guard on terminals

c	
Power Module Type and Voltage <sup>(1)</sup>	
Code	Description
<b>Full Voltage – Incandescent</b>	
12	12V AC/DC
24	24V AC/DC
48	48V AC/DC
<b>Full Voltage – LED</b>	
2	12...130V AC/DC
<b>Transformer</b>	
16	120V AC, 50/60 Hz
26	240V AC, 50/60 Hz
<b>Operator Only <sup>(2)</sup></b>	
00	No power module

d		
No. of Positions		
800T Code	Description	800H Code
H	2-position	HR

e	
Knob Color	
Code	Description
A	Amber
B	Blue
C	Clear
G	Green
R	Red
W	White
X	No knob

- (1) For other voltages, consult your local distributor.
- (2) Operator only supplied without power module, lamp, lens cap, or contact blocks.

f	
Illumination Options	
Code	Description
Blank	Incandescent
H	LED

g	
Operator Function and Knob Type	
Code	Operator Function
<b>Standard Knob or No Knob</b>	
2	Maintained
4	Spring return from left
5	Spring return from right
<b>Knob Lever</b>	
17	Maintained
18	Spring return from left
19	Spring return from right

h	
Cam Options (2-position)	
Code	Operator Function
KB6	Maintained cam
KL8	Spring return cam

i, j	
Contact Blocks <sup>(1)</sup>	
Code	Description
Blank (both pos.)	No contacts
<b>Standard</b>	
D	1 N.O.
E	1 N.C.
A	1 N.O. - 1 N.C.
X	No contacts in this position
<b>PenTUFF (Low Voltage)</b>	
H	1 N.O.
U	1 N.C.
F	1 N.O. - 1 N.C.
<b>Class I, Div. 2 - Explosion-protected</b>	
0	1 N.O. - 1 N.C.
<b>Class I, Div. 2 - Logic Reed</b>	
V	1 N.O.
W	1 N.C.
T	1 N.O. - 1 N.C.
<b>Class I, Div. 2 - Stackable Sealed Switch</b>	
5	1 N.O.
6	1 N.C.
7	1 N.O. - 1 N.C.

Table 7 - Selector Switch Cam Targets

Cam Description (2-position)		
Target		Contact Block Code <sup>(2)</sup>
0	X	D, H, V, R, 5
X	0	E, U, W, S, 6

X = Closed/0 = Open

- (1) Contact blocks are used on white side only.
- (2) Target tables are reversed for spring return from left operators.

Table 8 - Contact Block Code Reduction Rules

Contact Block Substitution	
Combination	Code
<b>Standard</b>	
D + E	A
D + D	M
E + E	N

# 3-position Knob/Lever Type – Illuminated



Standard Knob Operator  
Cat. No. 800T-16JR2KB7AX



Standard Knob Operator  
Cat. No. 800H-16JRR2KB7AX

800 T - 16 J R 2 KB7 A X  
a b c d e f g h i j

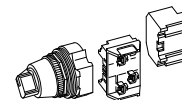

a	
Protection Rating	
Code	Description
T	Metal, Type 4/13
H	Plastic, Type 4/4X/13

b	
Fingersafe Guards	
Code	Description
Blank	No guards
C	Guard on terminals

c	
Power Module Type and Voltage <sup>(1)</sup>	
Code	Description
<b>Full Voltage – Incandescent</b>	
12	12V AC/DC
24	24V AC/DC
48	48V AC/DC
<b>Full Voltage – LED</b>	
2	12...130V AC/DC
<b>Transformer</b>	
16	120V AC, 50/60 Hz
26	240V AC, 50/60 Hz
<b>Operator Only <sup>(2)</sup></b>	
00	No power module

d		
No. of Positions		
800T Code	Description	800H Code
J	2-position	JR

e	
Knob Color	
Code	Description
A	Amber
B	Blue
C	Clear
G	Green
R	Red
W	White
X	No knob

- (1) For other voltages, consult your local Rockwell Automation sales office or Allen-Bradley distributor.
- (2) Operator only supplied without power module, lamp, lens cap, or contact blocks.

f	
Illumination Options	
Code	Description
Blank	Incandescent
H	LED

g	
Operator Function and Knob Type	
Code	Operator Function
<b>Standard Knob or No Knob</b>	
2	Maintained
4	Spring return from left
5	Spring return from right
91	Spring return from both
<b>Knob Lever</b>	
17	Maintained
18	Spring return from left
19	Spring return from right
20	Spring return from both

h	
Cam Options (3-position)	
Code	Description
KB7	B7 cam
KC1	C1 cam
KC7	C7 cam
KE7	E7 cam
KQ1	Q1 cam
KT1	T1 cam

i, j	
Contact Blocks <sup>(1)</sup>	
Code	Description
Blank (both pos.)	No contacts
<b>Standard</b>	
A	1 N.O. - 1 N.C.
X	No contacts in this position
<b>PentTUFF (Low Voltage)</b>	
F	1 N.O. - 1 N.C.
<b>Class I, Div. 2 - Explosion-protected</b>	
O	1 N.O. - 1 N.C.
<b>Class I, Div. 2 - Logic Reed</b>	
T	1 N.O. - 1 N.C.
<b>Class I, Div. 2 - Stackable Sealed Switch</b>	
7	1 N.O. - 1 N.C.

- (1) Contact blocks are used on white side only.

Table 9 - Selector Switch Cam Targets

Target			Cam Description (3-position)					
KB7	KC1	KC7	KE7	KQ1	KT1			
X	O	O	D, H, V, R, 5	–	D, H, V, R, 5	D, H, V	–	E, U, W, S, 6
O	X	O	–	E, U, W, S, 6	E, U, W, S, 6	–	E, U, W, S, 6	–
O	O	X	E, U, W, S, 6	D, H, V, R, 5	–	–	–	D, H, V, R, 5
X	X	O	G, I	J, Q	–	–	–	J, Q
O	X	X	J, Q	–	J, Q	E, U, W, S, 6	–	–
X	O	X	–	G, I	G, I	–	D, H, V, R, 5	–

X = Closed/O = Open



Transformer Type Pilot Light  
Cat. No. 800T-P16R



Push-to-test Pilot Light  
Cat. No. 800T-PT16R

800    T    -    P    T    16    G    AR  
          a    b    c    d    e    f    g    h

(Push-to-test)

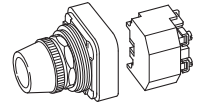

a	
Protection Rating <sup>(1)</sup>	
Code	Description
T	Metal, Type 4/13
H	Plastic, Type 4/4X/13

b	
Fingersafe Guards	
Code	Description
Blank	No guards
C	Guards on terminals

c		
Power Module Type		
800T Code	Description	800H Code
P	Transformer (or dual input)	PR
Q	Full voltage	QR
S	Operator only <sup>(6)</sup>	SR

d	
Lamp Test Options	
Code	Description
Blank	No test option <sup>(2)</sup>
T	Push-to-test <sup>(3)</sup>
D	Dual input – diode <sup>(4)(5)</sup>
DT	Dual input – transformer relay <sup>(5)</sup>

- (1) All pilot lights except push-to-test without sealed contacts and dual-input transformer relay, are rated for Class I, Division 2 applications.
- (2) Non-push-to-test pilot lights using the universal LED option cannot be ordered as Bulletin 800HC or 800TC. The terminals are fingersafe as standard.
- (3) Push-to-test supplied with factory jumpered contact block. For typical pilot light wiring diagrams, see [page 23](#).
- (4) Diode type dual input provides circuit isolation via opposing diodes. Not recommended for use with solid-state outputs.
- (5) Dual-input devices (diode or transformer type) cannot be ordered as Bulletin 800HC or 800TC. Fingersafe terminal guards are not available.
- (6) Operator-only supplied without power module, lamp, or lens. For push-to-test operator-only, order [Momentary Contact Devices – Illuminated on page 10](#).

e	
Illumination Options	
Code	Description
Blank	Incandescent
H	LED <sup>(2)</sup>

f	
Voltage	
Code	Description
Transformer	
16	120V AC, 50/60 Hz
26	240V AC, 50/60 Hz
46	480V AC, 50/60 Hz
56	600V AC, 50/60 Hz
Full Voltage – Incandescent	
12	12V AC/DC
24	24V AC/DC
48	48V AC/DC
10	120V AC/DC
20	240V AC/DC
Full Voltage – LED	
2	12...130V AC/DC
Dual Input	
16	120V AC
24	24V AC/DC (dual-input diode only)
Operator Only	
00	No power module

g		
Lens Color		
Code	Description	Glass Code <sup>(1)</sup>
Blank	No lens	Blank
A	Amber	D
B	Blue	E
C	Clear	F
G	Green	H
R	Red	J
W	White	K
Y	Yellow	–

h	
Contact Blocks (Push-to-test Units Only)	
Code	Description
Standard	
Blank	1 N.O. - 1 N.C.
PenTUFF™ (Low Voltage)	
AV	1 N.O. - 1 N.C.
Class I, Div. 2 - Explosion-protected	
AF	1 N.O. - 1 N.C.
Class I, Div. 2 - Logic Reed	
AR	1 N.O. - 1 N.C.
Class I, Div. 2 - Stackable Sealed Switch	
AY	1 N.O. - 1 N.C.

- (1) Glass lens available on 800T pilot lights only. Not available on push-to-test units.
- (2) LED illumination option is not available with diode type dual input.

# Typical Pilot Light Wiring Diagrams

**IMPORTANT** See applicable codes and laws.

**Push-to-test Pilot Light Device Schematic**

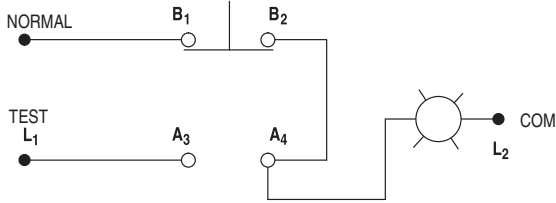

**Dual-input Diode Pilot Light Device Schematic**

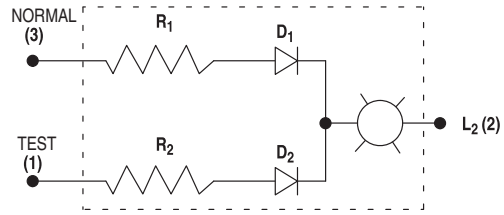

**Dual-input Pilot Light Typical Application Wiring Diagram**

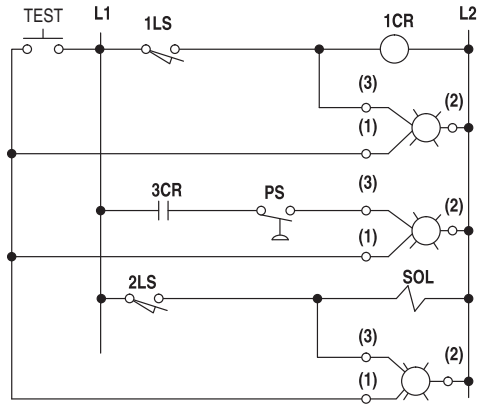

**Dual-input Pilot Light Transformer Type Device Schematic**

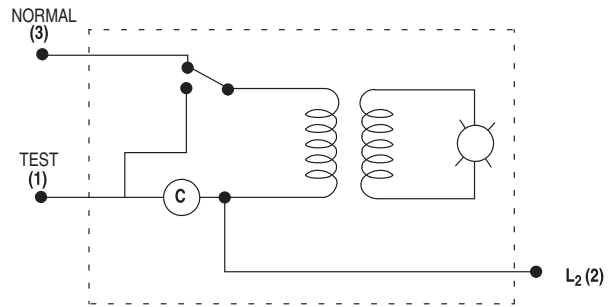

# Push-pull and Push-pull/Twist Release Devices

## 2-position – Non-illuminated



A jumbo or large legend plate is recommended, if space allows.



2-position Push-pull  
Cat. No. 800T-FX6D4



2-position Metal Push-pull  
Cat. No. 800TC-FXLE6D4S



2-position Push-pull/Twist  
Cat. No. 800T-FXT6D4



2-position Push-pull/Twist  
Cat. No. 800H-FRXT6D4

**800**    **T**    **-**    **FX**    **1**    **A1**  
          a    b            c    d    e

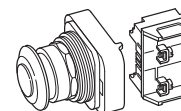





a	
Protection Rating	
Code	Description
T	Metal, Type 4/13
H	Plastic, Type 4/4X/13

b	
Fingersafe Guards	
Code	Description
Blank	No guards
C	Guards on terminals

c		
Head Type		
800T Code	Description	800H Code
FX	Mushroom head (push-pull)	–
FXC	90 mm anodized aluminum head (push-pull) <sup>(3)</sup>	–
FXJ	Jumbo mushroom head (push-pull)	–
FXJE	Jumbo mushroom head (push-pull) with E-stop <sup>(4)</sup>	–
FXL	63 mm anodized aluminum head (push-pull) <sup>(5)</sup>	–
FXLE	63 mm anodized aluminum head (push-pull) with E-stop <sup>(4)</sup>	–
FXT	Push-pull/twist-to-release	FRXT
FXJT	Jumbo head push-pull with twist-to-release	FRXJT

d	
Color Cap	
Code	Description
Blank	No cap <sup>(2)</sup>
1	Green
2	Black
3	Orange
4	Gray
5	White
6	Red
7	Blue
8	Gold
9	Yellow

e			
Contact Blocks <sup>(1)</sup>			
Code	Operator Position		Description
			
Blank	–	–	No contacts
Standard			
D1	0	X	1 N.O.
D2	X	0	1 N.C.
D4	X	0	1 N.C.L.B. <sup>(6)</sup>
A	0 X	X 0	1 N.O. - 1 N.C.
A1	0 X	X 0	1 N.O. - 1 N.C.L.B. <sup>(6)</sup>
A5	X X	0 0	2 N.C.L.B. <sup>(6)(7)</sup>
PenTUFF™ (Low Voltage)			
D1V	0	X	1 N.O.
D2V	X	0	1 N.C.
D4V	X	0	1 N.C.L.B.
AV	0 X	X 0	1 N.O. - 1 N.C.

e (cont'd)			
Contact Blocks			
Code	Operator Position		Description
			
Blank	–	–	No contacts
Class I, Div. 2 – Explosion-protected			
AF	0 X	X 0	1 N.O. - 1 N.C.
BF	0 X 0 X	X 0 0 X	2 N.O. - 2 N.C.
Class I, Div. 2 – Logic Reed			
D1R	0	X	1 N.O.
D2R	X	0	1 N.C.
AR	0 X	X 0	1 N.O. - 1 N.C.
Class I, Div. 2 – Stackable Sealed Switch			
D1Y	0	X	1 N.O.
D2Y	X	0	1 N.C.
AY	0 X	X 0	1 N.O. - 1 N.C.

X = Closed/0 = Open

(1) Devices with N.C.L.B. contacts meet EN ISO 13850 and IEC 60947-5-5 standards for emergency stop applications.

(2) Only valid with Head Types FX, FXT, and FRXT.

(3) Head Type FXC only available in red and gold.

(4) Head Types FXJE and FXLE only available in red. "E-stop" on cap is not compliant with EN ISO 13850.

(5) Head Type FXL only available in blue, red, and gold.

(6) Normally closed late break contact. When button is pushed from the OUT to IN position, the mechanical detent action of the operator occurs before electrical contacts change state. When the button is pulled from the IN in the OUT position, the electrical contacts change state before the mechanical detent occurs.

(7) Two Cat. No. 800T-XD4 contact blocks supplied.



### 3-position – Non-illuminated

**IMPORTANT** A jumbo or large legend plate is recommended, if space allows.



3-position Push-pull  
Cat. No. 800T-FXM6A7



3-position Push-pull  
Cat. No. 800H-FRXM6A7

**800**   **T**   **-**   **FX**   **M**   **1**   **A7**  
           a       b           c       d       e       f

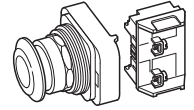

a	
Protection Rating	
Code	Description
T	Metal, Type 4/13
H	Plastic, Type 4/4X/13

b	
Fingersafe Guards	
Code	Description
Blank	No guards
C	Guards on terminals

c		
Head Type		
800T Code	Description	800H Code
FX	Mushroom head (push-pull)	FRX
FXC	90 mm anodized aluminum head (push-pull) <sup>(1)</sup>	–
FXJ	Jumbo mushroom head (push-pull)	FRXJ
FXL	63 mm anodized aluminum head (push-pull) <sup>(2)</sup>	–

d			
Operator Function			
Code	Operator Position		
M	Momentary	Maintained	Maintained
N	Momentary	Maintained	Momentary

- (1) Head Type FXC only available in red and gold.
- (2) Head Type FXL only available in blue, red, and gold.

e	
Color Cap	
Code	Description
Blank	No cap <sup>(1)</sup>
1	Green
2	Black
3	Orange
4	Gray
5	White
6	Red
7	Blue
8	Gold
9	Yellow

f				
Contact Blocks				
Code	Operator Position			Description
Blank	–	–	–	No contacts
Standard				
A	0 X	0 0	X 0	1 N.O. - 1 N.C.
A1	0 X	0 X	X 0	1 N.O. - 1 N.C.L.B.
A7	X X	0 X	0 0	1 N.C. - 1 N.C.L.B.
B6	X X X X	0 X 0 X	0 0 0 0	2 N.C. - 2 N.C.L.B.

f (cont'd)				
Contact Blocks				
Code	Operator Position			Description
Blank	–	–	–	No contacts
PenTUFF (Low Voltage)				
AV	0 X	0 0	X 0	1 N.O. - 1 N.C.
Class I, Div. 2 - Explosion-protected				
AF	0 X	0 0	X 0	1 N.O. - 1 N.C.
Class I, Div. 2 - Logic Reed				
AR	0 X	0 0	X 0	1 N.O. - 1 N.C.
Class I, Div. 2 - Stackable Sealed Switch				
AY	0 X	0 0	X 0	1 N.O. - 1 N.C.

X = Closed/0 = Open

- (1) Only valid with Head Types FX and FRX.

## 2-position – Illuminated

**IMPORTANT** A jumbo or large legend plate is recommended, if space allows.



2-position Push-pull  
Cat. No. 800T-FXP16RA1



2-position Push-pull  
Cat. No. 800T-FXJEP16RA1



2-position Push-pull/Twist  
Cat. No. 800T-FXTP16RA1



2-position Push-pull/Twist  
Cat. No. 800H-FRXT16RA1

**800**    **T**    **-**    **FX**    **PH**    **16**    **R**    **A1**  
           a        b        c        d        e        f        g

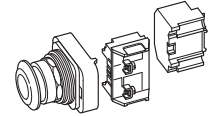

a	
Protection Rating	
Code	Description
T	Metal, Type 4/13
H	Plastic, Type 4/4X/13

b	
Fingersafe Guards	
Code	Description
Blank	No guards
C	Guards on terminals

c		
Head Type		
800T Code	Description	800H Code
FX	Mushroom head with metal ring (push-pull)	–
FXJ	Jumbo mushroom head (push-pull)	–
FXJE	Jumbo mushroom head with “E-stop” (push-pull) <sup>(1)</sup>	–

c (cont'd)		
Head Type		
800T Code	Description	800H Code
FXR	Mushroom head, all plastic (push-pull)	–
FXT	Push-pull/twist release	FRXT
FXJT	Jumbo head push-pull/twist release	FRXJT

(1) “E-stop” on cap is not compliant with EN ISO 13850.

d	
Illumination Options	
Code	Description
<b>Transformer</b>	
P	Incandescent
PH	LED
<b>Full Voltage</b>	
Q	Incandescent
QH	Universal LED
<b>Dual Input</b>	
D	Diode type <sup>(2)</sup>
DT	Transformer – relay type
DTH	Transformer – relay type LED
<b>Operator Only</b>	
S	No power module <sup>(3)</sup>

e	
Voltage	
Code	Description
<b>Transformer</b>	
16	120V AC, 50/60 Hz
26	240V AC, 50/60 Hz
46	480V AC, 50/60 Hz
56	600V AC, 50/60 Hz
<b>Full Voltage</b>	
12	12V AC/DC
24	24V AC/DC
48	48V AC/DC
10	120V AC/DC
20	240V AC/DC
<b>Universal – LED</b>	
2	12...130V AC/DC
<b>Dual Input</b>	
16	120V AC
24	24V AC/DC (dual-input diode only)
<b>Operator Only</b>	
00	–

f	
Color Cap	
Code	Description
X	No cap (not valid with jumbo heads)
A	Amber
B	Blue
C	Clear
G	Green
R	Red
W	White

g		
Contact		
N.O.	0	X
N.C./N.C.L.B.	X	0
X = Closed/0 = Open		
Contact Blocks <sup>(1)</sup>		
Code	Description	
Blank	No contacts	
Standard		
D1	1 N.O.	
D2	1 N.C.	
D4	1 N.C.L.B.	
A	1 N.O. - 1 N.C.	
A1	1 N.O. - 1 N.C.L.B.	
A5	2 N.C.L.B. <sup>(4)</sup>	
PenTUFF (Low Voltage)		
D1V	1 N.O.	
D2V	1 N.C.	
D4V	1 N.C.L.B.	
AV	1 N.O. - 1 N.C.	

g (cont'd)	
Contact Blocks	
Code	Description
<b>Class I, Div. 2 - Explosion-protected</b>	
AF	1 N.O. - 1 N.C.
G1F	2 N.O. - 2 N.C.
<b>Class I, Div. 2 - Logic Reed</b>	
D1R	1 N.O.
D2R	1 N.C.
AR	1 N.O. - 1 N.C.
<b>Class I, Div. 2 - Stackable Sealed Switch</b>	
D1Y	1 N.O.
D2Y	1 N.C.
AY	1 N.O. - 1 N.C.

(1) Devices with N.C.L.B. contacts meet EN ISO 13850 and IEC 60947-5-5 standards for emergency stop applications.  
 (2) Diode type dual input provides circuit isolation via opposing diodes. Not recommended for use with solid-state outputs.  
 (3) Operator-only option supplied without power module, lamp, or lens.  
 (4) Two stacked Cat. No. 800T-XD4 contacts blocks are supplied.

### 3-position – Illuminated



3-position Push-pull  
Cat. No. 800T-FXMP16RA7



3-position Push-pull  
Cat. No. 800H-FRXMP16A7

800 T - FX M PH 16 R A1  
a b c d e f g h

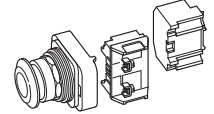

a	
Protection Rating	
Code	Description
T	Metal, Type 4/13
H	Plastic, Type 4/4X/13

b	
Fingersafe Guards	
Code	Description
Blank	No guards
C	Guards on terminals

c		
Head Type		
800T Code	Description	800H Code
FX	Mushroom head (push-pull)	FRX
FXJ	Jumbo mushroom head (push-pull)	FRXJ

d			
Operator Function			
Code	Operator Position		
	Out	Ctr.	In
M	Momentary	Maintained	Maintained
N	Momentary	Maintained	Momentary

e	
Illumination Options	
Code	Description
Transformer	
P	Incandescent
PH	LED
Full Voltage	
Q	Incandescent
QH	Universal LED
Dual Input	
D	Diode type <sup>(1)</sup>
DT	Transformer – relay type
DTH	Transformer – relay type LED
Operator Only	
S	No power module <sup>(2)</sup>

f	
Voltage	
Code	Description
Transformer	
16	120V AC, 50/60 Hz
26	240V AC, 50/60 Hz
46	480V AC, 50/60 Hz
56	600V AC, 50/60 Hz
Full Voltage	
12	12V AC/DC
24	24V AC/DC
48	48V AC/DC
10	120V AC/DC
20	240V AC/DC
Universal – LED	
2	12...130V AC/DC
Dual Input	
16	120V AC
24	24V AC/DC (dual-input diode only)
Operator Only	
00	–

g	
Color Cap	
Code	Description
X	No cap (not valid with jumbo heads)
A	Amber
B	Blue
C	Clear
G	Green
R	Red
W	White

h			
Target			
Contact			
	Out	Ctr.	In
N.O.	0	0	X
N.C.	X	0	0
N.C.L.B.	X	X	0
Contact Blocks			
Code	Description		
Blank	No contacts on operator		
Standard			
A	1 N.O. - 1 N.C.		
A1	1 N.O. - 1 N.C.L.B.		
A7	1 N.C. - 1 N.C.L.B.		
PenTUFF (Low Voltage)			
AV	1 N.O. - 1 N.C.		
Class I, Div. 2 - Explosion-protected			
AF	1 N.O. - 1 N.C.		
Class I, Div. 2 - Logic Reed			
AR	1 N.O. - 1 N.C.		
Class I, Div. 2 - Stackable Sealed Switch			
AY	1 N.O. - 1 N.C.		

Note: X = Closed/0 = Open

(1) Diode type dual input provides circuit isolation via opposing diodes. Not recommended for use with solid-state outputs and neon indicators.  
 (2) Operator-only option supplied without power module, lamp, or lens.

## Potentiometer Devices



Cat. No. 800T-U24



Cat. No. 800H-UR4

Resistance	Type 4/13	Type 4/4X/13	Resistance	Type 4/13	Type 4/4X/13
	Potentiometer (1) (2) (3)	Potentiometer (1) (2) (3)		Potentiometer (1) (2) (3)	Potentiometer (1) (2) (3)
	Cat. No.	Cat. No.		Cat. No.	Cat. No.
Operator only without resistive element	800T-N37 <sup>(4)</sup>	800H-N102	25 kΩ	800T-U37	800H-UR37
150 Ω	800T-U4	800H-UR4	50 kΩ	800T-U41	800H-UR41
500 Ω	800T-U12	800H-UR12	75 kΩ	800T-U46	800H-UR46
1000 Ω	800T-U13	800H-UR13	100 kΩ	800T-U49	800H-UR49
1500 Ω	800T-U16	800H-UR16	150 kΩ	800T-U50	800H-UR50
2500 Ω	800T-U19	800H-UR19	400 kΩ	800T-U54	800H-UR54
5000 Ω	800T-U24	800H-UR24	500 kΩ	800T-U55	800H-UR55
10 kΩ	800T-U29	800H-UR29	1 MΩ	800T-U57	800H-UR57
15 kΩ	800T-U34	800H-UR34	2 MΩ	800T-U59	800H-UR59
20 kΩ	800T-U35	800H-UR35	3 MΩ	800T-U62	800H-UR62
			4 MΩ	800T-U64	800H-UR64

(1) Single-turn operation with 312° rotation.

(2) Does not meet Class I, Div. 2 applications.

(3) Rated for 300V AC/DC, 2 W maximum (6V DC minimum). Specify Bulletin 800TC or 800HC for fingersafe potentiometers. Example: Cat. No. 800T-U29 becomes Cat. No. 800TC-U29.

(4) For use with Type J potentiometers having a shaft length of 7/8 in. (22.2 mm) and a shaft diameter of 1/4 in. (6.3 mm).

## Mechanically Interlocked Maintained Push Button Devices



Cat. No. 800T-FA22A



Cat. No. 800T-FB16A



Cat. No. 800T-FC16F



Cat. No. 800H-CRA22A

Contact Arrangement		Type 4/13			Type 4/4X/13	
		Button Position: Button Type/Color <sup>(1)</sup>			Bootless <sup>(2)</sup>	
Contact Type	Configuration/ Position	Upper: Flush/Black Lower: Flush/Black	Upper: Flush/Green Lower: Extended/Red	Upper: Flush/Green Lower: Mushroom/Red	Upper: Flush/Green Lower: Extended/Red	Upper: Flush/Black Lower: Flush/Black
		Cat. No.	Cat. No.	Cat. No.	Cat. No.	Cat. No.
1 N.O. - 1 N.C.		800T-FA22A	800T-FB16A	800T-FC16A	800H-CRB16A	800H-CRA22A
2 N.O. - 2 N.C.		800T-FA22F	800T-FB16F	800T-FC16F	800H-CRB16F	800H-CRA22F
No contact	—	800T-FA22	800T-FB16	800T-FC16	800H-CRB16	800H-CRA22

(1) Consult your local Rockwell Automation sales office or Allen-Bradley distributor for other operator types and combinations.

(2) If booted operators are desired, refer to [page 47](#) to order boots separately.

## 18 mm Small Pilot Lights Type 4/13, Class I, Division 2

800T - PS D 16 R  
          a       b       c       d       e

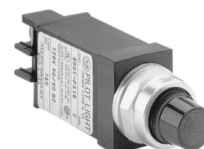

a	
Power Module Type	
Code	Description
PS	Transformer (or dual input)
QS	Full voltage

b	
Lamp Test Options	
Code	Description
Blank	No test option
D	Dual-input diode
DT	Dual-input transformer relay <sup>(1)</sup>
T	Push-to-test <sup>(1)</sup>

c	
Illumination Options	
Code	Description
Transformer/Full Voltage/Dual Input	
Blank	Incandescent
H	LED

d	
Voltage	
Code	Description
Transformer	
16	120V AC 50/60 Hz
Full-voltage Incandescent	
12	12V AC/DC
24	24V AC/DC
Full-voltage LED	
10	120V AC
13	130V AC/DC
24	24V AC/DC
Dual Input	
24	24V AC/DC <sup>(2)</sup>

e	
Plastic Lens Color	
Code	Description
Blank	No lens
A	Amber
B	Blue
C	Clear
G	Green
R	Red
W	White

(1) Class I, Division 2 rating not available. Push-to-test rated for Type 13 only.

(2) Dual-input diode only.

# Cluster Pilot Light Devices (Bulletin 800T Only)

**IMPORTANT** Rated Type 4/13 indoor only.



Color Cap Only With Lamps  
Cat. No. 800T-N251L



Complete Unit  
Cat. No. 800T-PCL416

800T - PCL 3 16 W R X R  
a b c d e f g h  
Pos 1 Pos 2 Pos 3 Pos 4

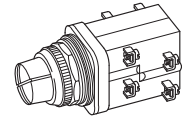

a	
Fingersafe Guards	
Code	Description
Blank	No guards
C	Guards on terminals

b	
Power Module Type	
Code	Description
QCL	Full voltage LED
PCL	Transformer LED

c	
Number of Units	
Code	Description
2	2-unit cluster
3	3-unit cluster
4	4-unit cluster

d	
Voltage Options	
Code	Description
Full Voltage	
12	12V AC/DC
24	24V AC/DC
Transformer	
16	120V AC, 50/60 Hz

e, f, g, h	
Color Options	
Code	Description
Blank (all 4 positions)	Standard unit
X	No color
A	Amber
B	Blue
C	Clear
G	Green
R	Red
W	White

## Custom Lens Caps for Cluster Pilot Lights

800T - N251 L R G A W  
a b c d e f  
Pos 1 Pos 2 Pos 3 Pos 4



a	
No. of Lamps/Voltage	
Code	Description
N250	4 lamps, 12V AC/DC <sup>(1)</sup>
N251	4 lamps, 24V AC/DC
N253	3 lamps, 12V AC/DC <sup>(1)</sup>
N254	3 lamps, 24V AC/DC
N256	2 lamps, 12V AC/DC <sup>(1)</sup>
N257	2 lamps, 24V AC/DC

b	
Illumination Options	
Code	Description
L	LED

c, d, e, f	
Color Options	
Code	Description
Blank (all 4 positions)	Standard unit
X	No color
A	Amber
B	Blue
C	Clear
G	Green
R	Red
W	White

(1) For transformer type cluster pilot lights, order 12V rated caps.

Figure 1 - Standard Units

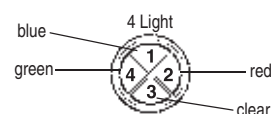
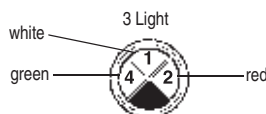
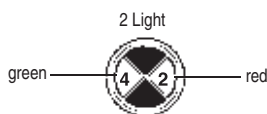

# 1-, 2-, 3-, 4-way Toggle Switches (Bulletin 800T Only)

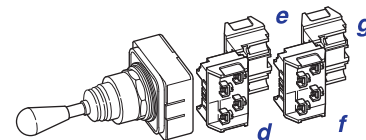
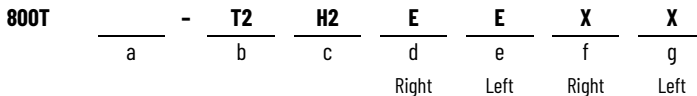

a	
Fingersafe Guards	
Code	Description
Blank	No guards
C	Guards on terminals

b	
Operator Type	
Code	Description
T1	1-way toggle
T2	2-way toggle
T3	3-way toggle
T4	4-way toggle

c						
Lever Movement and Function						
Type	Function Code	Description				
		↑	←	→	↓	
1-way	↑ A	1	M	-	-	
		2	S	-	-	
	← B	1	-	M	-	
		2	-	S	-	
	→ C	1	-	-	M	
		2	-	-	S	
	↓ D	1	-	-	-	M
		2	-	-	-	S
2-way	E ↑	1	M	M	-	
		2	M	S	-	
		3	S	S	-	
		4	S	M	-	
	F ←	1	-	M	M	
		2	-	M	S	
		3	-	S	S	
		4	-	S	M	
G ↓	1	-	-	M	M	
	2	-	-	M	S	
	3	-	-	S	S	
	4	-	-	S	M	
H ↔	1	M	-	-	M	
	2	M	-	-	S	
	3	S	-	-	S	
	4	S	-	-	M	
J ↗	1	M	-	M	-	
	2	M	-	S	-	
	3	S	-	S	-	
	4	S	-	M	-	
K ↘	1	-	M	-	M	
	2	-	M	-	S	
	3	-	S	-	S	
	4	-	S	-	M	

c (cont'd)						
Lever Movement and Function						
Type	Function Code	Description				
		↑	←	→	↓	
3-way	L ↑	1	M	M	M	
		2	M	M	S	
		3	M	S	M	
		4	M	S	S	
	N ↓	1	-	M	M	M
		2	-	M	M	S
		3	-	M	S	M
		4	-	M	S	S
3-way	P ↖	1	M	-	M	M
		2	M	-	M	S
		3	M	-	S	M
		4	M	-	S	S
	Q ↗	1	M	M	-	M
		2	M	M	-	S
		3	M	S	-	M
		4	M	S	-	S
4-way	R ↔	1	M	M	M	M
		2	M	M	M	S
		3	M	M	S	M
		4	M	M	S	S
	T ↑	1	M	S	M	M
		2	M	S	M	S
		3	M	S	S	M
		4	M	S	S	S
T ↓	1	S	M	M	M	
	2	S	M	M	S	
	3	S	M	S	M	
	4	S	M	S	S	
T ↖	1	S	S	M	M	
	2	S	S	S	M	
	3	S	S	M	S	
	4	S	S	S	S	

d, e, f, g	
Contact Blocks	
Code	Description
Blank (all pos.)	No contacts
Standard	
D	1 N.O.
E	1 N.C.
G	1 N.O.E.M.
J	1 N.C.L.B.
A	1 N.O. - 1 N.C.
X	No contacts in this position
PenTUFF™ (Low Voltage)	
H	1 N.O.
U	1 N.C.
I	1 N.O.E.M.
Q	1 N.C.L.B.
F	1 N.O. - 1 N.C.
Class I, Div. 2 - Explosion-protected	
O	1 N.O. - 1 N.C.
Class I, Div. 2 - Logic Reed	
V	1 N.O.
W	1 N.C.
T	1 N.O. - 1 N.C.
Class I, Div. 2 - Stackable Sealed Switch	
5	1 N.O.
6	1 N.C.
7	1 N.O. - 1 N.C.

**Note:** M = Maintained,  
S = Spring Return  
See [Table 10 on page 32](#) for Contact Block Code.  
See [Table 11 on page 32](#) for 1, 2, 3, and 4 Way Toggle Switch Cam Targets

## Contact Block Code and Cam Target Table

Table 10 - Contact Block Code

Contact Block Substitution	
Combination	Code
<b>Standard</b>	
D + E	A
D + D	M <sup>(1)</sup>
E + E	N
J + D	B
J + E	C

(1) XA2 and XA2R contact blocks cannot be stacked upon, but they can stack on other contact blocks.

Table 11 - 1-, 2-, 3-, and 4-way Toggle Switch Cam Targets

Contact Configuration					Suffix Code	
Position					Contact/Side	
Up	Left	Center	Right	Down	Left Side	Right Side
0	X	0	0	0	—	D, H, V, R, 5
0	0	0	0	X	—	E, U, W, S, 6
X	0	X	X	X	—	J, Q
X	X	X	X	0	—	G, I
X	0	0	0	0	E, U, W, S, 6	—
0	0	0	X	0	D, H, V, R, 5	—
0	X	X	X	X	G, I	—
X	X	X	0	X	J, Q	—

X = Closed, 0 = Open



# Selector Push Button Devices (Bulletin 800T Only)



Cat. No. 800T-K2AAXX

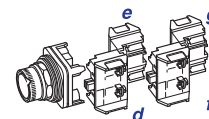
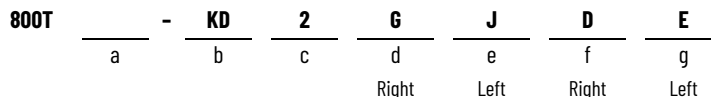

a	
Fingersafe Guards	
Code	Description
Blank	No guards
C	Guards on terminals

b	
Cam and Head Type	
Code	Description
K	A cam with flush operator
KA	A cam with extended operator
KB	B cam with flush operator
KC	C cam with flush operator
KD	D cam with flush operator
KE	E cam with flush operator
<b>Note:</b> See <a href="#">Table 13</a> for Target description of each cam.	

c	
Color Cap	
Code	Description
1	Green
2	Black
6	Red

d, e, f, g	
Contact Blocks	
Code	Description
Blank (all positions)	No contacts on operator
Standard	
D	1 N.O.
E	1 N.C.
G	1 N.O.E.M.
J	1 N.C.L.B.
A	1 N.O. - 1 N.C.
X	No contacts in this pos.
PenTUFF (Low Voltage)	
H	1 N.O.
U	1 N.C.
I	1 N.O.E.M.
Q	1 N.C.L.B.
F	1 N.O. - 1 N.C.

d, e, f, g (cont'd)	
Contact Blocks	
Code	Description
Class I, Div. 2 - Explosion-protected	
0	1 N.O. - 1 N.C.
Class I, Div. 2 - Logic Reed	
V	1 N.O.
W	1 N.C.
T	1 N.O. - 1 N.C.
Class I, Div. 2 - Stackable Sealed Switch	
5	1 N.O.
6	1 N.C.
7	1 N.O. - 1 N.C.

Table 12 - Contact Block Code

Contact Block Substitution	
Combination	Code
Standard	
D + E	A
D + D	M <sup>(1)</sup>
E + E	N
J + D	B
J + E	C

(1) XA2 and XA2R contact blocks cannot be stacked upon, but they can stack on other contact blocks.

Table 13 - Selector Push Button Cam Targets

Sleeve Position				Cam Description									
↻		↺		KA/K		KB		KC		KD		KE	
Button Free	Button Pressed	Button Free	Button Pressed	Contact Block Side									
				Left		Right		Left		Right		Left	
0	0	0	X	—	—	D, H, V, R, 5	—	D, H, V, R, 5	—	—	—	—	—
0	0	X	0	E, U, W, S, 6	E, U, W, S, 6	—	—	—	—	E, U, W, S, 6	—	E, U, W, S, 6	—
0	0	X	X	—	—	—	—	—	—	—	E, U, W, S, 6	—	E, U, W, S, 6
0	X	0	0	—	—	—	—	D, H, V, R, 5	—	D, H, V, R, 5	—	D, H, V, R, 5	—
0	X	0	X	D, H, V, R, 5	D, H, V, R, 5	—	D, H, V, R, 5	—	—	D, H, V, R, 5	—	D, H, V, R, 5	—
0	X	X	0	—	—	—	—	—	—	—	—	—	—
X	0	X	0	J or Q	J or Q	—	E, U, W, S, 6	—	—	J or Q	—	J or Q	—
X	X	0	0	—	—	—	—	—	—	—	G or I	—	G or I
X	X	0	X	G or I	G or I	—	—	—	—	G or I	—	G or I	—
X	0	X	X	—	—	—	—	—	E, U, W, S, 6	—	J or Q	—	J or Q
X	X	X	0	—	—	E, U, W, S, 6	—	E, U, W, S, 6	—	—	—	—	—

X = Closed, 0 = Open

## Cylinder Lock Push Button Devices (Bulletin 800T only)



Cylinder Lock Push Button  
Cat. No. 800T-E15A



Mushroom Style Cylinder Lock  
Cat. No. 800T-E15M6A

Type of Cylinder Lock	Lock Position	Type 4/13	
		Standard Cylinder Lock	Red Mushroom Cylinder Lock
		Cat. No. (1)	Cat. No. (1) (2)
Spring Bolt – Lock can be set with key when button is in the OUT position. Button locks when pressed. Key is removable in any position. 1 N.O. - 1 N.C.	IN	800T-E15A	800T-E15M6A
Dead Bolt A – Button can only be operated with the key in the lock. Key removable in locked position only. 1 N.O. - 1 N.C.	IN	800T-E24A	800T-E24M6A
	OUT	800T-E14A	800T-E14M6A
Dead Bolt B – Button can be operated with or without the key inserted in the lock. Key removable in any position. 1 N.O. - 1 N.C.	IN	800T-E12A	800T-E12M6A
	OUT	800T-E11A	800T-E11M6A

(1) Each device supplied with two keys. Replacement key part no. for standard E158 is X-144218.

(2) For jumbo size mushroom cap, change M to J. Example: Cat. No. 800T-E15M6A becomes Cat. No. 800T-E15J6A.

## Momentary Padlocking Mushroom Head Devices (Bulletin 800T only)



Padlocking Mushroom Button  
Cat. No. 800T-D6QA



Padlocking Jumbo Mushroom Button  
Cat. No. 800T-D6LQA

Contact Type (1)	Button Color	Type 4/13	
		Standard Metal Mushroom Head	Jumbo Metal Mushroom Head
		Cat. No. (2)	Cat. No.
No contact	Red	800T-D6Q	800T-D6LQ
1 N.O.		800T-D6QD1	800T-D6LQD1
1 N.C.		800T-D6QD2	800T-D6LQD2
1 N.O. - 1 N.C.		800T-D6QA	800T-D6LQA

(1) Allows locking in the depressed position. Holds N.C. contacts open, but may not hold N.O. contacts closed.

(2) To order without the padlocking attachment, change Q to F. Example: Cat. No. 800T-D6QA becomes Cat. No. 800T-D6FA

## Momentary Wobble Stick Push Button Devices (Bulletin 800T Type 13 only)



Wobble Stick Unit  
Cat. No. 800T-M1B

Contact Type	Cat. No. (1)
No contacts	800T-M1
1 N.O.	800T-M1D1
1 N.O. - 1 N.C.	800T-M1A
2 N.O. - 2 N.C.	800T-M1B

(1) Can be operated from any angle.

## Momentary Contact Flip Lever Devices (Bulletin 800H Type 4/4X Only)



Flip Lever Operator  
Cat. No. 800H-WK42B



Flip Lever Operator  
Cat. No. 800H-WK61B

800H    -    WK    6    1    A  
          a            b            c            d

a	
Fingersafe Guards	
Code	Description
Blank	No guards
C	Guards on terminals

b	
Operator Color	
Code	Description
4	Gray
6	Red

c			
Operator Types			
Code	Description	Code	Description
—	Blank	20	OUT
1	STOP	21	RAISE
2	START	22	RESET
3	CLOSE	23	REVERSE
4	DOWN	24	RIGHT
5	EMERG. STOP	25	RUN
6	FAST	26	SECOND SPEED
7	FORWARD	27	SLOW
8	FULL SPEED	28	TEST
9	HIGH	29	THIRD SPEED
10	IN	30	UP
11	INCH	31	0
12	JOG	32	I
13	LEFT	33	AVANT
14	LOW	34	OUVRIR
15	LOW SPEED	35	ARRIER
16	LOWER	36	MARCHE
17	OFF	37	ESSAI
18	ON	38	ARRET
19	OPEN		

d	
Contact Blocks	
Code	Description
Blank	No contacts
Standard	
D1	1 N.O.
D2	1 N.C.
D3	1 N.O.E.M.
D4	1 N.C.L.B.
D5	1 N.O. (Mini)
D6	1 N.C. (Mini)
A1	1 N.O. - 1 N.C.L.B.
A2	2 N.O.
A4	2 N.C.
A7	1 N.C. - 1 N.C.L.B.
A	1 N.O. - 1 N.C.
B	2 N.O. - 2 N.C.
PentTUFF (Low Voltage)	
D1V	1 N.O.
D2V	1 N.C.
D3V	1 N.O.E.M.
D4V	1 N.C.L.B.
AV	1 N.O. - 1 N.C.
BV	2 N.O. - 2 N.C.
Class I, Div. 2 - Explosion-protected	
AF	1 N.O. - 1 N.C.
BF	2 N.O. - 2 N.C.
Class I, Div. 2 - Logic Reed	
D1R	1 N.O.
D2R	1 N.C.
A2R	2 N.O.
A4R	2 N.C.
AR	1 N.O. - 1 N.C.
BR	2 N.O. - 2 N.C.
Class I, Div. 2 - Stackable Sealed Switch	
D1Y	1 N.O.
D2Y	1 N.C.
AY	1 N.O. - 1 N.C.
BY	2 N.O. - 2 N.C.

## Break-Glass Push Button Stations (Bul. 800T only)

Table 14 - Complete Station









	Description	Contact Type	Cat. No.	
 <p>Cat. No. 800T-NX14</p>	<p><b>Break-Glass Push Button Station</b> Red push button station in a Type 4/13 enclosure incorporates either one or two snap-action contact blocks, which are operated when the small glass window is broken. Includes a STOP legend.</p>		1 N.O. - 1 N.C.	800T-NX14
			2 N.O. - 2 N.C.	800T-NX15

Table 15 - Miscellaneous Kits

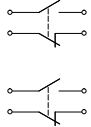
	Description	Contact Type	Cat. No.	
 <p>Cat. No. 800T-S6M</p>	<p><b>Unit Only Kit</b> The break-glass unit less the enclosure is available as a kit to install into your enclosure. The kit includes the contact unit, the hammer and chain, and five extra glass discs with one button tack. This kit excludes legend plate. For legend plates, see <a href="#">page 55</a>.</p>		1 N.O. - 1 N.C.	800T-S6M
			2 N.O. - 2 N.C.	800T-S6N
 <p>Cat. No. 800T-NXM</p>	<p><b>Replacement Snap Action Contact Block Kit</b> This kit is used to replace the snap action contact block.</p>		1 N.O. - 1 N.C.	800T-NXM
			2 N.O. - 2 N.C.	800T-NXN
 <p>Cat. No. 800T-N28</p>	<p><b>Glass Disc Kit</b> Each replacement kit for break-glass push button units or stations consists of six glass discs and one button tack.</p>	<p><b>Description</b></p>		<p><b>Cat. No.</b></p>
	<p>800T-N28</p>			

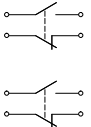
The table on [page 6](#) lists the most commonly used Bulletin 800T/800H push button stations. Stations that are not listed in this table can be ordered as custom-built stations.

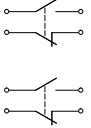





The following information is required when ordering custom-built push button stations:

- Catalog number of enclosure.
- Catalog number of control units.
- Legend plate catalog number and/or marking for each unit.
- Specify vertical/horizontal mounting.
- Specify desired operator mounting sequence. Inclusion of a sketch is recommended.

Submit your request to [RADBQuote@ra.rockwell.com](mailto:RADBQuote@ra.rockwell.com).

## Enclosures

**IMPORTANT** Enclosure and conduit dimensions are detailed on [page 70](#).

No. of Operator Openings	Surface Mount <sup>(1)</sup>	Flush Mount	Pendant Type	
	Die Cast (Type 4/13) <sup>(2)</sup>	Die Cast Faceplate (Type 4/13)	One Hole in Bottom (Type 13)	Openings in Cover (Type 13)
	 Cat. No. 800T-2TZ	 Cat. No. 800T-2ZT	 Cat. No. 800T-2PZ	 Cat. No. 800T-2PY
	Cat. No.	Cat. No.	Cat. No.	Cat. No.
1	800T-1TZ <sup>(3)</sup>	800T-1ZT	—	—
2	800T-2TZ <sup>(3)</sup>	800T-2ZT	800T-2PZ	800T-2PY
3	800T-3TZ <sup>(3)</sup>	800T-3ZT	—	800T-3PY
4	800T-4TZ <sup>(3)</sup>	800T-4ZT	—	800T-4PY
5	—	—	—	800T-5PY
6 <sup>(4)</sup>	800T-6TZ <sup>(3)</sup>	800T-6ZT	—	800T-6PY
6 <sup>(5)</sup>	800T-6THZ <sup>(3)</sup>	800T-6ZTH	—	—
7	—	—	—	—
8	—	—	—	—
9	800T-9TZ	800T-9ZT	—	—
10	—	—	—	—
12	800T-12TZ	800T-12ZT	—	—
16	800T-16TZ	800T-16ZT	—	—
20	—	—	—	—
25	—	—	—	—

(1) Bottom conduit entry. Grounding provision provided.

(2) Enclosure depth accommodates one shallow and one mini-contact block stacked.

(3) Add suffix Y to the cat. no. for yellow painted enclosure. Example: Cat. No. 800T-1TZY.

(4) One vertical row.

(5) Two vertical rows of three holes.

## Enclosures (Bulletin 800H only)

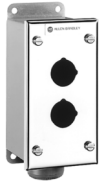

Stainless Steel  
Cat. No. 800H-2HZ4



Rosite Glass Polyester  
Cat. No. 800H-2HZ4R



Fiberglass  
Cat. No. 800H-2HZ4Y



Thermoplastic Polyester  
Cat. No. 800H-2HZ4C

No. of Operator Openings	Conduit Hubs <sup>(1)</sup>		Stainless Steel (#304) Type 4/4X/13 <sup>(2)</sup>	Rosite Glass Polyester Type 4/4X/13	No. of Operator Openings	Conduit Openings		Fiberglass <sup>(3)</sup> Type 4/4X/13	Thermoplastic Polyester <sup>(4)</sup> <sup>(5)</sup> Type 4/4X
	No.	Dia. [in.]	Cat. No.	Cat. No.		No.	Dia. [in.] <sup>(6)</sup>	Cat. No.	Cat. No.
0 <sup>(7)</sup>	1	3/4	800H-0HZ4	—	1	1	3/4	800H-1HZ4Y	800H-1HZ4C
1	1	3/4	800H-1HZ4	800H-1HZ4R	2	1	1	800H-2HZ4Y	800H-2HZ4C
1	2	3/4	—	800H-1HZ4RM1	3	1	1	800H-3HZ4Y	800H-3HZ4C
1	1	1	—	800H-1HZ4RM2	4	—	—	—	800H-4HZ4C
2	1	3/4	800H-2HZ4	800H-2HZ4R	—	—	—	—	—
2	2	3/4	800H-2HZ4M1	800H-2HZ4RM1	—	—	—	—	—
2	1	1	800H-2HZ4M2	800H-2HZ4RM2	—	—	—	—	—
3	1	3/4	800H-3HZ4	800H-3HZ4R	—	—	—	—	—
3	2	3/4	800H-3HZ4M1	800H-3HZ4RM1	—	—	—	—	—
4	1	3/4	800H-4HZ4	800H-4HZ4R	—	—	—	—	—
4	2	3/4	800H-4HZ4M1	800H-4HZ4RM1	—	—	—	—	—
5	1	1	800H-5HZ4	—	—	—	—	—	—
6	1	1	800H-6HZ4	800H-6HZ4R	—	—	—	—	—
7	1	1	800H-7HZ4	—	—	—	—	—	—
8	1	1	800H-8HZ4	—	—	—	—	—	—

- (1) Other combinations of conduit hub sizes are available upon request. Enclosure and conduit dimensions are detailed on [page 70](#).
- (2) Grounding screw provided with stainless steel enclosure.
- (3) Extra deep. Accommodates two levels of stackable sealed switch contact blocks.
- (4) No conduit openings provided.
- (5) Add a Y to the cat. no. for yellow thermoplastic enclosures. Example: Cat. No. 800H-1HZ4C becomes Cat. No. 800H-1HZ4CY. For more options, see [General-purpose Enclosures on page 74](#).
- (6) Conduit hubs must be ordered separately. For 3/4 in. hub, order Cat. No. 1490-N9. For 1 in. hub, order Cat. No. 1490-N10.
- (7) Identical to Cat. No. 800H-1HZ4 but without mounting holes.

## Contact Blocks

Contact blocks are packaged in kit form for field installation. All necessary mounting hardware is provided with each contact block kit. Contact ratings are listed on [page 4](#).

- IMPORTANT**
- It is recommended that contact blocks are mounted no more than two blocks deep.
  - Time delay contacts are only available as one circuit per operator.

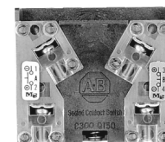

Contact Type	Shallow Block <sup>(1) (2)</sup>		PenTUFF™ (Low Voltage) Block <sup>(1) (2)</sup>		Logic Reed Block <sup>(2) (3)</sup>		Explosion-protected Block <sup>(1) (3)</sup>		Stackable Sealed Switch Block <sup>(3)</sup>	
	Cat. No.	Code	Cat. No.	Code	Cat. No.	Code	Cat. No.	Code	Cat. No.	Code
1 N.O.	800T-XD1	D	800T-XD1V	H	800T-XD1R	V	—	—	800T-XD1Y	5
1 N.C.	800T-XD2	E	800T-XD2V	U	800T-XD2R	W	—	—	800T-XD2Y	6
1 N.O.E.M.	800T-XD3	G	800T-XD3V	I	—	—	—	—	—	—
1 N.C.L.B.	800T-XD4	J	800T-XD4V	Q	—	—	—	—	—	—
1 N.O. - N.C.	800T-XA	A	800T-XAV	F	800T-XAR	T	800TC-XAF	0	800T-XAY	7
2 N.O.	800T-XA2 <sup>(4)</sup>	M	—	—	800T-XA2R <sup>(4)</sup>	Y	—	—	—	—
2 N.C.	800T-XA4	N	—	—	800T-XA4R	Z	—	—	—	—
1 N.C.L.B. - 1 N.O.	800T-XA1	B	—	—	—	—	—	—	—	—
1 N.C.L.B. - 1 N.C.	800T-XA7	C	—	—	—	—	—	—	—	—

- (1) Contact blocks with normally closed contacts meet direct drive positive opening standard requirements when properly fused to IEC 269-1 and 269-2. Shallow/mini contacts: 10 A gl or N type cartridge fuse. PenTUFF contacts: 6 A gl or N type cartridge fuse.
- (2) Specify Bulletin 800TC for fingersafe contact blocks. Example: Cat. No. 800T-XA becomes Cat. No. 800TC-XA.
- (3) Suitable for use in a Class I, Div. 2 hazardous location when device is installed in a suitable UL Listed enclosure.
- (4) Additional contacts cannot be stacked on XA2 and XA2R contact blocks.



Contact Type	Self-Monitoring Contact Block (SMCB) <sup>(1) (2)</sup>	
	Cat. No.	Code
1 N.C.L.B. (wired in series with 1 N.O. monitoring contact)	800TC-XD4S	3

Contact Type	Mini Block <sup>(1) (2)</sup>		Time Delay Block <sup>(3)</sup>	MaxDuty Block <sup>(2)</sup>	
	Cat. No.	Code	Cat. No.	Cat. No.	Code
1 N.O.	800T-XD5	K	800T-XT	800T-XD1M	1
1 N.C.	800T-XD6	L	800T-XS	800T-XD2M	2
1 N.C.L.B.	—	—	—	800T-XD4M	4

- (1) Contact blocks with normally closed contacts meet direct drive positive opening standard requirements when properly fused to IEC 269-1 and 269-2. Shallow/mini contacts: 10 A gl or N type cartridge fuse. PenTUFF contacts: 6 A gl or N type cartridge fuse.
- (2) Must be mounted on the first level of the operator. The N.O. monitoring contact automatically closes when the S.M.C.B. is properly installed onto the operator. If the S.M.C.B. is separated from the operator, the N.O. monitoring contact automatically opens.

- (1) Contact blocks with normally closed contacts meet direct drive positive opening standard requirements when properly fused to IEC 269-1 and 269-2. Shallow/mini contacts: 10 A gl or N type cartridge fuse. PenTUFF contacts: 6 A gl or N type cartridge fuse.
- (2) Specify Bulletin 800TC for fingersafe contact blocks. Example: Cat. No. 800T-XD5 becomes Cat. No. 800TC-XD5.
- (3) For contact ratings, see [page 4](#).



Description	Cat. No.
Contact block mounting screw <sup>(1)</sup>	800T-N335
Screw retainer	800T-N336
Actuator extender <sup>(2)</sup>	800T-N337

- (1) Not compatible with explosion-protected, stackable sealed switch, and mini contact blocks.
- (2) Not compatible with explosion-protected and self-monitoring contact blocks.

## Contact Block Code Descriptions – Traditional Type

Table 16 - Standard Contact Blocks

Code	Description	Non-illuminated	Illuminated
Blank	No contacts	X	X <sup>(1)</sup>
	1 N.O., 1 N.C.	–	X <sup>(2)</sup>
A	1 N.O., 1 N.C.	X	X
A1	1 N.C.L.B., 1 N.O.	X	X
A16	1 N.O., 1 N.C. (in position 2)	X <sup>(3)</sup>	–
A1S	1 N.C.L.B. (self-monitoring), 1 N.O.	X <sup>(4)</sup>	X <sup>(4)</sup>
A2	2 N.O.	X	X
A4	2 N.C.	X	X
A5	2 N.C.L.B.	X <sup>(4)</sup>	X <sup>(4)</sup>
A5S	2 N.C.L.B. (self-monitoring)	X <sup>(4)</sup>	–
A7	1 N.C.L.B., 1 N.C.	X	X
B	2 N.O., 2 N.C.	X	–
B6	2 N.C.L.B., 2 N.C.	X <sup>(4)</sup>	–
C	4 N.O., 4 N.C.	X	–
D1	1 N.O.	X	X
D2	1 N.C.	X	X
D3	1 N.O.E.M.	X	X
D4	1 N.C.L.B.	X	X
D4S	1 N.C.L.B. (self-monitoring)	X <sup>(4)</sup>	X <sup>(4)</sup>
F	2 N.O., 2 N.C.	X <sup>(3)</sup>	–
F8	2 N.C.	X <sup>(3)</sup>	–
F9	2 N.O.	X <sup>(3)</sup>	–
G1	2 N.O., 2 N.C.	–	X
H	3 N.O., 3 N.C.	X	–
J	4 N.O., 4 N.C.	X <sup>(3)</sup>	–
K	3 N.O., 3 N.C.	X <sup>(3)</sup>	–
X	No contacts	–	X <sup>(5)</sup>

- (1) Trigger action E-stops and push-pull units
- (2) Momentary contact push buttons and push-to-test pilot lights
- (3) Mechanically interlocked units
- (4) Push-pull units
- (5) Momentary contact push buttons

Table 17 - Mini Contact Blocks

Code	Description	Non-illuminated	Illuminated
D5	1 N.O.	X	–
D6	1 N.C.	X	–

Table 18 - PentUFF Contact Blocks

Code	Description	Non-illuminated	Illuminated
AV	1 N.O., 1 N.C.	X	X
A16V	1 N.O., 1 N.C. (in position 2)	X <sup>(1)</sup>	–
BV	2 N.O., 2 N.C.	X	–
CV	4 N.O., 4 N.C.	X	–
D1V	1 N.O.	X	X
D2V	1 N.C.	X	X
D3V	1 N.O.E.M.	X	X
D4V	1 N.C.L.B.	X	X
FV	2 N.O., 2 N.C.	X <sup>(1)</sup>	–
F8V	2 N.C.	X <sup>(1)</sup>	–
F9V	2 N.O.	X <sup>(1)</sup>	–
G1V	2 N.O., 2 N.C.	–	X
HV	3 N.O., 3 N.C.	X	–
JV	4 N.O., 4 N.C.	X <sup>(1)</sup>	–
KV	3 N.O., 3 N.C.	X <sup>(1)</sup>	–

- (1) Mechanically interlocked units

Table 19 - MaxDuty Contact Blocks

Code	Description	Non-illuminated	Illuminated
D1M	1 N.O.	X	X
D2M	1 N.C.	X	X
D4M	1 N.C.L.B.	X	X

Table 20 - Snap Action Contact Blocks

Code	Description	Non-illuminated	Illuminated
M	1 N.O., 1 N.C.	X <sup>(1)</sup>	--
N	2 N.O., 2 N.C.	X <sup>(1)</sup>	--

- (1) Momentary contact push buttons

Table 21 - Time Delay Contact Blocks

Code	Description	Non-illuminated	Illuminated
S	1 N.C.	X <sup>(1)</sup>	–
T	1 N.O.	X <sup>(1)</sup>	–

- (1) Momentary contact push buttons



Table 22 - Logic Reed Contact Blocks <sup>(1)</sup>

Code	Description	Non-illuminated	Illuminated
AR	1 N.O., 1 N.C.	X	X
A16R	1 N.O., 1 N.C. (in position 2)	X <sup>(2)</sup>	—
A2R	2 N.O.	X	X
A4R	2 N.C.	X	X
BR	2 N.O., 2 N.C.	X	—
CR	4 N.O., 4 N.C.	X	—
D1R	1 N.O.	X	X
D2R	1 N.C.	X	X
FR	2 N.O., 2 N.C.	X <sup>(2)</sup>	—
F8R	2 N.C.	X <sup>(2)</sup>	—
F9R	2 N.O.	X <sup>(2)</sup>	—
G1R	2 N.O., 2 N.C.	—	X
HR	3 N.O., 3 N.C.	X	—
JR	4 N.O., 4 N.C.	X <sup>(2)</sup>	—
KR	3 N.O., 3 N.C.	X <sup>(2)</sup>	—

(1) Class I Div. 2 rated

(2) Mechanically interlocked units

Table 24 - Stackable Sealed Switch Contact Blocks <sup>(1)</sup>

Code	Description	Non-illuminated	Illuminated
AY	1 N.O., 1 N.C.	X	X
A16Y	1 N.O., 1 N.C. (in position 2)	X <sup>(2)</sup>	—
BY	2 N.O., 2 N.C.	X	—
CY	4 N.O., 4 N.C.	X	—
D1Y	1 N.O.	X	X
D2Y	1 N.C.	X	X
FY	2 N.O., 2 N.C.	X <sup>(2)</sup>	—
F8Y	2 N.C.	X <sup>(2)</sup>	—
F9Y	2 N.O.	X <sup>(2)</sup>	—
G1Y	2 N.O., 2 N.C.	—	X
HY	3 N.O., 3 N.C.	X	—
JY	4 N.O., 4 N.C.	X <sup>(2)</sup>	—
KY	3 N.O., 3 N.C.	X <sup>(2)</sup>	—

(1) Class I Div. 2 rated

(2) Mechanically interlocked units

Table 23 - Explosion-protected Contact Blocks <sup>(1)</sup>

Code	Description	Non-illuminated	Illuminated
AF	1 N.O., 1 N.C.	X	X
A16F	1 N.O., 1 N.C. (in position 2)	X <sup>(2)</sup>	—
BF	2 N.O., 2 N.C.	X	—
CF	4 N.O., 4 N.C.	X	—
FF	2 N.O., 2 N.C.	X <sup>(2)</sup>	—
G1F	2 N.O., 2 N.C.	—	X
HF	3 N.O., 3 N.C.	X	—
JF	4 N.O., 4 N.C.	X <sup>(2)</sup>	—
KF	3 N.O., 3 N.C.	X <sup>(2)</sup>	—

(1) Class I Div. 2 rated

(2) Mechanically interlocked units

## Contact Block Code Descriptions – Modular Type

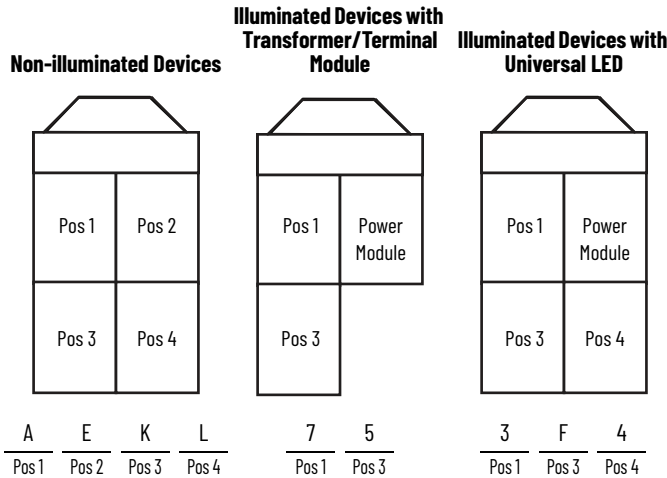

**Table 25 - Standard Contact Blocks**

Code	Configuration	
A	1 N.O., 1 N.C.	800T-XA
B	1 N.C.L.B., 1 N.O.	800T-XA1
C	1 N.C.L.B., 1 N.C.	800T-XA7
D	1 N.O.	800T-XD1
E	1 N.C.	800T-XD2
G	1 N.O.E.M.	800T-XD3
J	1 N.C.L.B.	800T-XD4
M <sup>(1)</sup>	2 N.O.	800T-XA2
N	2 N.C.	800T-XA4
3 <sup>(2)</sup>	1 SMCB	800TC-XD4S
X	—	No block this position

- (1) Cannot be stacked upon
- (2) Can only be configured in positions 1 and 2

**Table 26 - Mini Contact Blocks**

Code	Configuration	
K <sup>(1)</sup>	1 N.O.	800T-XD5
L <sup>(1)</sup>	1 N.C.	800T-XD6
X	—	No block this position

- (1) Cannot be stacked upon

**Table 27 - PenTUFF Contact Blocks**

Code	Configuration	
F	1 N.O., 1 N.C.	800T-XAV
H	1 N.O.	800T-XD1V
I	1 N.O.E.M.	800T-XD3V
Q	1 N.C.L.B.	800T-XD4V
U	1 N.C.	800T-XD2V
X	—	No block this position

**Table 28 - MaxDuty Contact Blocks**

Code	Configuration	
1	1 N.O.	800T-XD1M
2	1 N.C.	800T-XD2M
4	1 N.C.L.B.	800T-XD4M
X	—	No block this position

**Table 29 - Logic Reed Contact Blocks<sup>(1) (2)</sup>**

Code	Configuration	
T	1 N.O., 1 N.C.	800T-XAR
V	1 N.O.	800T-XD1R
W	1 N.C.	800T-XD2R
γ <sup>(3)</sup>	2 N.O.	800T-XA2R
Z	2 N.C.	800T-XA4R
X	—	No block this position

- (1) Class I Div. 2 rated
- (2) Logic reed contact blocks can only be configured with other logic reed contact blocks
- (3) Cannot be stacked upon

**Table 30 - Explosion-protected Contact Blocks<sup>(1) (2)</sup>**

Code	Configuration	
0	1 N.O., 1 N.C.	800TC-XAF
X	—	No block this position

- (1) Class I Div. 2 rated
- (2) Explosion-protected contact blocks can only be configured with other explosion-protected contact blocks

**Table 31 - Stackable Sealed Switch Contact Blocks<sup>(1) (2)</sup>**

Code	Configuration	
5	1 N.O.	800T-XD1Y
6	1 N.C.	800T-XD2Y
7	1 N.O., 1 N.C.	800T-XAY
X	—	No block this position

- (1) Class I Div. 2 rated
- (2) Stackable sealed switch contact blocks can only be configured with other stackable sealed switch contact blocks

# Power Modules

Packaged in kit form for field installation. Lamps are listed on [page 53](#).

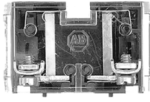

Full Voltage <sup>(1)</sup>		Transformer <sup>(1)</sup>		Dual Input		
Lamp Voltage	Cat. No.	Voltage	Cat. No.	Type	Voltage	Cat. No.
6...130V AC/DC	800T-N330	48V AC 50/60 Hz	800T-N325	Transformer <sup>(2)</sup>	120V AC	800T-N296
		120V AC 50/60 Hz	800T-N326	Diode Type <sup>(3)</sup>	24V AC/DC	800T-N291N
		240V AC 50/60 Hz	800T-N327		120V AC/DC	800T-N290N
		277V AC 50/60 Hz	800T-N327Y		—	—
		480V AC 50/60 Hz	800T-N328	—	—	
240V AC/DC <sup>(4)</sup>	800T-N331	600V AC 50/60 Hz	800T-N329	—	—	—

- (1) Specify Bulletin 800TC for fingersafe power modules. Example: Cat. No. 800T-N330 becomes Cat. No. 800TC-N330.
- (2) Transformer type dual input provides circuit isolation via a miniature type relay. This module is used with a 120V transformer.
- (3) Diode type dual input provides circuit isolation via opposing diodes. Not recommended for use with solid-state outputs and neon indicators.
- (4) 240V full-voltage module contains 50% dropping resistors for use with a 120V incandescent lamp.

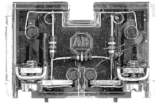
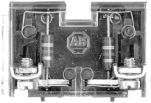

Resistor (10% Drop) <sup>(1)</sup>		Neon <sup>(1) (2)</sup>	
Voltage	Cat. No.	Voltage	Cat. No.
120V AC/DC	800T-N332	120V AC/DC	800T-N333
		240V AC/DC	800T-N334



- (1) Specify Bulletin 800TC for fingersafe power modules. Example: Cat. No. 800T-N332 becomes Cat. No. 800TC-N332.
- (2) Neon modules contain resistors.

# Universal LED Module

Allows mounting of contact blocks when used with illuminated momentary contact push button and push-pull operators. This module is used with 800T-N376x LED lamps (see [Table 32 on page 53](#)).

	Voltage	Cat. No.
	12...130V AC/DC	800TC-N374

# Trigger Action E-stop Latches

	Description	Cat. No.
	Illuminated type	800T-N380
	Non-illuminated type	800T-N379

## Replacement Color Caps

The following color caps are for field replacement on installed devices or for completion of devices that are ordered with color caps omitted.



Push-Pull



Push-Pull/Twist



Push-Pull Jumbo



Push-Pull/Twist Jumbo

### Push-Pull Color Caps, Illuminated

Color	800T Push-Pull	800H Push-Pull	800T/H Push-Pull/Twist	800T/H Push-Pull Jumbo	800T/H Push-Pull/Twist Jumbo
	Cat. No.	Cat. No.	Cat. No.	Cat. No.	Cat. No.
Amber	800T-N159A	800H-N112A	800T-N301A	800T-N209A	800T-N306A
Blue	800T-N159B	800H-N112B	800T-N301B	800T-N209B	800T-N306B
Clear	800T-N159C	800H-N112C	800T-N301C	800T-N209C	800T-N306C
Green	800T-N159G	800H-N112G	800T-N301G	800T-N209G	800T-N306G
Red	800T-N159R	800H-N112R	800T-N301R	800T-N209R	800T-N306R
White	800T-N159W	800H-N112W	800T-N301W	800T-N209W	800T-N306W



Illuminated Mushroom



Illuminated Jumbo Mushroom



Standard



Push-to-test



Glass Caps for Pilot Lights

Color	800T/H Push Button Color Caps, Illuminated		800T/H Pilot Light Color Caps			Glass Caps for 800T Pilot Lights
	Mushroom	Jumbo Mushroom	Standard	Push-to-test	18 mm	
	Cat. No.	Cat. No.	Cat. No.	Cat. No.	Cat. No.	
Amber	800T-N304A	800T-N305A	800T-N26A	800T-N42	800T-N122A	800T-N22
Blue	800T-N304B	800T-N305B	800T-N26B	800T-N43	800T-N122B	800T-N23
Clear	800T-N304C	800T-N305C	800T-N26C	800T-N45	800T-N122C	800T-N25
Green	800T-N304G	800T-N305G	800T-N26G	800T-N41	800T-N122G	800T-N21
Red	800T-N304R	800T-N305R	800T-N26R	800T-N40	800T-N122R	800T-N20
White	800T-N304W	800T-N305W	800T-N26W	800T-N44	800T-N122W	800T-N24
Yellow	—	—	800T-N26Y	800T-N46	—	—

The following color caps are for field replacement on installed devices or for completion of devices that are ordered with color caps omitted.



Plastic Mushroom



Plastic Jumbo Mushroom



Padlocking Metal Mushroom



Metal Jumbo Mushroom

**Push Button Color Caps, Non-Illuminated**

Button Color	800T Plastic Mushroom	800H Plastic Mushroom	800T Plastic Jumbo Mushroom	800H Plastic Jumbo Mushroom	800T Padlocking Metal Mushroom	800T Metal Jumbo Mushroom
	Cat. No.	Cat. No.	Cat. No.	Cat. No.	Cat. No.	Cat. No.
Red	800T-N246R	800H-N114A	800T-N247R	800H-N115A	800T-N311R	800T-N248R <sup>(1)</sup>
Green	800T-N246G	800H-N114B	800T-N247G	800H-N115B	800T-N311G	800T-N248G <sup>(1)</sup>
Black	800T-N246B	800H-N114H	800T-N247B	800H-N115H	800T-N311B	800T-N248B <sup>(1)</sup>
Orange	800T-N246O	800H-N114F	800T-N247O	800H-N115F	—	—
Gray	800T-N246GR	800H-N114G	800T-N247GR	800H-N115G	—	—
Blue	800T-N246BL	800H-N114C	800T-N247BL	800H-N115C	—	—
Yellow	800T-N246Y	800H-N114E	800T-N247Y	800H-N115E	800T-N311Y	800T-N248Y <sup>(1)</sup>
Natural	—	—	—	—	—	—
White	800T-N246W	800H-N114L	—	800H-N115L	—	—

(1) For padlocking jumbo mushroom style, change listed cat. no. from 248 to 313. Example: Cat. No. 800T-N248G becomes Cat. No. 800T-N313G.



Push-Pull



Push-Pull/Twist



Push-Pull Jumbo



Push-Pull/Twist Jumbo

**800T/H Push-Pull Color Caps, Non-Illuminated**

Button Color	800T/H Push-Pull Color Caps, Non-Illuminated			
	Push-Pull	Push-Pull/Twist	Push-Pull Jumbo	Push-Pull/Twist Jumbo
	Cat. No.	Cat. No.	Cat. No.	Cat. No.
Red	800T-N160A	800T-N302A	800T-N208A	800T-N307A
Green	800T-N160B	800T-N302B	800T-N208B	800T-N307B
Blue	800T-N160C	800T-N302C	800T-N208C	800T-N307C
Yellow	800T-N160E	800T-N302E	800T-N208E	800T-N307E
Orange	800T-N160F	800T-N302F	800T-N208F	800T-N307F
Gray	800T-N160G	800T-N302G	800T-N208G	800T-N307G
Black	800T-N160H	800T-N302H	800T-N208H	800T-N307H
White	800T-N160L	800T-N302L	800T-N208L	800T-N307L

## Selector Switch Knobs – Illuminated





Standard Knob



Knob Lever

Color	800T Knob Type		800H Knob Type	
	Standard Knob	Knob Lever	Standard Knob	Knob Lever
	Cat. No.	Cat. No.	Cat. No.	Cat. No.
Amber	800T-N297A	800T-N298A	800H-N154A	800H-N155A
Blue	800T-N297B	800T-N298B	800H-N154B	800H-N155B
Clear	800T-N297C	800T-N298C	800H-N154C	800H-N155C
Green	800T-N297G	800T-N298G	800H-N154G	800H-N155G
Red	800T-N297R	800T-N298R	800H-N154R	800H-N155R
White	800T-N297W	800T-N298W	800H-N154W	800H-N155W

## Selector Switches

	Description	Item	Color	Cat. No.
 <p>Standard Knob Lever</p> <p>Coin Slot</p> <p>Wing Lever</p>	<b>800T Knobs and Actuators for Selector Switches</b> Selector switch knobs can be changed in the field. Standard knob and knob levers can be ordered with white inserts or with a packet of colored inserts, which includes one insert of each color.	Standard Knob	White	800T-N230F
		Knob Lever	Kit	800T-N230
			White	800T-N231F
		Wing Lever	Kit	800T-N231
			Gray	800T-N238
Coin Slot	Black Only	800T-N239		
	800H Knob	Standard Knob	White	800H-N145F
	Description	Color	Cat. No.	
	<b>800T/H Color Insert Kits</b> Available on Selector switches with removable color inserts. Standard knob and knob levers use the same insert. If color All is selected, a packet of color inserts is furnished which includes one of each color. Color Insert kits can also be ordered with operators at no additional charge.	Red	800T-N124	
		Green	800T-N125	
		Blue	800T-N126	
		Yellow	800T-N127	
		White	800T-N128	
		Orange	800T-N286	
		All	800T-N123	

## Booted Selector Switch Knobs (800H only) – Non-illuminated

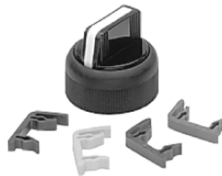

Insert Material	Material			
	Chlorosulfonated Polyethylene <sup>(1)</sup>	Silicone <sup>(1)</sup>	Urethane <sup>(1)</sup>	Ethylene Propylene <sup>(1)</sup>
	Cat. No.	Cat. No.	Cat. No.	Cat. No.
Brass	800H-NR5 <sup>(2)</sup>	800H-NR101 <sup>(2)</sup>	800H-NR100 <sup>(2)</sup>	800H-NR103 <sup>(2)</sup>
Stainless Steel	800HS-NR5	800HS-NR101	800HS-NR100	800HS-NR103

(1) Dots that are printed on the inside of the boot identify the boot material. See [Protective Boot Application Information on page 47](#) for a description of the materials.

(2) Color insert packet (Cat. No. 800T-N123) is included in each kit.

## Protective Boots

### Protective Boot for Illuminated Push Buttons



Cat. No. 800H-N11



Cat. No. 800H-N12

Description	Type	Cat. No.
Can be added to guarded units, units without guard, or push-to-test devices. This protective boot guards against the entrance of foreign materials reaching the opening between the button and locking ring.	Boot without Guard	800H-N11
	Boot with Guard	800H-N12

### Protective Boots for Non-illuminated Push Buttons

**IMPORTANT** Can be added to flush or extended head push button units to help protect against foreign materials reaching the opening between the button and the locking ring.

Boots supplied with control stations and components are made of a chlorosulfonated polyethylene material with stainless steel insert ring. To order boots with silicone, urethane, or ethylene propylene material, see the following table that shows the material application information.

Insert Material	Boot Color	Material			
		Chlorosulfonated Polyethylene <sup>(1)</sup>	Silicone • <sup>(1)</sup>	Urethane •• <sup>(1)</sup>	Ethylene • Propylene •• <sup>(1)</sup>
		Cat. No.	Cat. No.	Cat. No.	Cat. No.
Stainless steel <sup>(2)</sup>	Red	800H-N5A	800H-N101R	800H-N100R	800H-N103R
	Green	800H-N5B	800H-N101G	800H-N100G	800H-N103G
	Black	800H-N5H	800H-N101B	800H-N100B	800H-N103B
	Yellow	800H-N5E	800H-N101Y	800H-N100Y	—
	Blue	800H-N5C	800H-N101BL	800H-N100BL	—

(1) Dots that are printed on the inside of the boot identify the boot material.

(2) Series B boots incorporate a stainless steel insert as standard.



### Protective Boot Application Information

Material	Description
Chlorosulfonated Polyethylene (synthetic rubber)	Resistant to attack by oxidizing chemicals such as concentrated sulfuric acid and hypochlorite solutions. Also resistant to attack by oils and performs well in a wide range of other chemicals and solvents. Good flex and high impact resistance. The standard boot material that is supplied with 800H NEMA Type 4/4X push buttons unless otherwise specified.
Silicone	Excellent high temperature resistance. Suited for use where organic acids or vegetable oils are present. Also excellent resistance to the effects of outdoor use, such as oxygen, ozone, and weather.
Urethane	Excellent resistance to mechanical failure. Most durable boot material. Suited for use where lubricating oils and automotive fuels are present. Also well suited for outdoor use.
Ethylene-propylene	Suited for high temperature applications. Resistant to attack by many acids and alkalies, detergents, phosphate esters, ketones, alcohols, and glycols. Outstanding service in areas with hot water and steam wash downs.

## Potentiometer Replacement Knobs









Description	Cat. No.
Type 4/13 (800T)	40274-073-55
Type 4/4X/13 (800H)	40274-073-54

## Push Buttons

	Description	Cat. No.
 <p>Cat. No. 800T-N179 (Operators not included)</p>	<p><b>Bul. 800T/H Mechanical Interlock</b> Used on momentary contact push button units. Guards against closing the N.O. contacts of one button while the other N.O. contacts of the button are closed. Buttons remain momentary. For maintained units, see <a href="#">page 29</a>.</p>	800T-N179
 <p>Cat. No. 800T-N12</p>	<p><b>Bul. 800T Rocker Arm Operating Lever</b> The rocker arm lever operates two flush head or one flush with one extended head momentary contact push button units spaced 1-27/32 in. (46.8 mm) center-to-center. Legend plates must be ordered separately and should be inverted 180° before engraving and installation.</p>	800T-N12

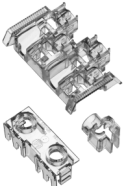

## Miscellaneous

	Description	Cat. No.
 Cat. No. 800T-N245	<b>Bul. 800T/H Mounting Ring Wrench</b> This wrench simplifies tightening or loosening the octagonal mounting ring that is used on Bul. 800T units. This wrench is double-ended and can be used for 18 mm and 30 mm pilot light mounting rings.	800T-N245
 Cat. No. 800T-N209RE1	<b>Bul. 800T/H Jumbo Push-Pull Cap</b> For use on Bul. 800T or 800H push-pull operators. Fits on illuminated and non-illuminated devices.	800T-N209RE <sup>(1)</sup>
	<b>Bul. 800T 63 mm Red Anodized Aluminum Cap</b> For use on Bul. 800T non-illuminated push-pull devices.	800T-N210R
	<b>Bul. 800T 63 mm Red Anodized Aluminum Cap with E-stop</b> For use on Bul. 800T non-illuminated push-pull devices.	800T-N210RE <sup>(1)</sup>
	<b>Bul. 800T 90 mm Gold Anodized Aluminum Cap</b> For use on Bul. 800T non-illuminated push-pull devices.	800T-N211GL
 Cat. No. 800T-N300	<b>Bul. 800T Bonding Bracket</b> The bonding bracket establishes an electrical circuit between the mounting surface and metal operator bushing for grounding purposes; recommended for installations that require CSA approval. Necessary mounting hardware is included. Order Cat. No. 800T-N300 for back-of-panel bracket. Order Cat. No. 800T-N300F for front-of-panel bracket.	800T-N300
		800T-N300F
 Cat. No. 800E-ALR1	<b>Bul. 800T/H Lens/Bulb Removal Tool</b> The small end of this tool provides quick and easy removal of any incandescent or LED lamp.	800F-ALR1
 IEC Fingersafe Accessories	<b>Bul. 800T/H IEC Fingersafe Terminal Guards</b> Snap-on accessories that provide IEC, IP2X, and VGB fingersafe protection. Single terminal guards for single circuit contact blocks, full-voltage modules, LED modules, and so on (800T-XD1, -XD2, -XD3, -XD4, -XD5, -XD6, -XAP, -XD1P, -XD2P, -PC..., and -QC...) <sup>(2)</sup>	800T-N322 <sup>(3)</sup>
	Transformer covers for transformer only.	800T-N324 <sup>(4)</sup>
	Multi-terminal side cover for use on single or double circuit contact blocks. (800T-XA, -XA1, -XA2, -XA4, -XA7, -XAR, -XA2R, -XA4R, -XD1R, and -XD2R)	800T-N323 <sup>(4)</sup>
 Cat. No. 800T-N292	<b>Gray Bul. 800T Trim Washer</b> Used to mount the operator properly when a legend plate is not being used.	800T-N292 <sup>(5)</sup>
	<b>Plastic Bul. 800H Trim Washer</b> Used to mount the operator properly when a legend plate is not being used.	800H-N148 <sup>(5)</sup>
 Cat. No. 800T-N293	<b>Metal Bul. 800T Thrust Washer</b> Used to help prevent rotation of operators in a keyed or notched hole.	800T-N293 <sup>(5)</sup>
	<b>Plastic Bul. 800H Thrust Washer</b> Used to help prevent rotation of operators in a keyed or notched hole.	800H-N146 <sup>(5)</sup>
	<b>Description</b>	<b>Color</b>
 Cat. No. 800T-N1	<b>Bul. 800T/H Closing Button</b> Where an enclosure or flush plate with more than the required number of openings is used, this button can be supplied to close the unused openings.	Gray
		Black
		<b>Cat. No.</b>
		800T-N1
		800T-N1B

(1) Does not comply with EN ISO 13850.









(2) Power modules excluding transformers and dual inputs.

(3) Must be ordered in multiples of 100 pieces.

(4) Must be ordered in multiples of 25 pieces.

(5) Must be ordered in multiples of 10 pieces.





## Locking Attachments

	Description	Cat. No.
 <p>Cat. No. 800T-N2 (Padlock not included)</p>	<p><b>Bul. 800T Extended Head Push Button Padlocking Attachments</b> Permits locking in the depressed position. Locks the normally closed contact in the open position. For extended head non-illuminated momentary push buttons.</p>	800T-N2
 <p>Cat. No. 800T-N10 (Padlock not included)</p>	<p><b>Bul. 800T Flush Head Push Button Padlocking Attachments</b> Permits locking in the depressed position. Locks the normally closed contact in the open position. For flush head push button.</p>	800T-N10
 <p>Cat. No. 800T-N315 (Padlock not included)</p>	<p><b>Bul. 800T Momentary Mushroom Padlocking Attachments</b> For Bul. 800T non-illuminated momentary mushroom push button. Requires use of Cat. No. 800T-N311 mushroom cap. This device is used to lock the mushroom button in a depressed position.</p>	800T-N315
 <p>Cat. No. 800T-N314 (Padlock not included)</p>	<p><b>Bul. 800T/H Push-Pull Padlocking Attachment</b> For 2-position push-pull and push-pull/twist release illuminated and nonilluminated operators. Use on standard head only (40 mm dia.). Locks the normally closed contacts open only. Conversion of normally closed late break contacts to standard normally closed contacts are recommended when using this accessory. Made of stainless steel.</p>	800T-N314
 <p>Cat. No. 800T-N163 (Padlock not included)</p>	<p><b>Bul. 800T/H Padlocking Cover</b> Guards against unauthorized operation for non-illuminated, standard knob selector switches and potentiometers. Stainless steel and clear plastic construction.</p>	800T-N163
 <p>Cat. No. 800T-N378 (Padlock not included)</p>	<p><b>Bul. 800T/H Trigger Action Padlocking Attachment</b> For 2-position trigger action E-stops with 45 mm heads.</p>	800T-N378
 <p>Cat. No. 800H-N140 (Padlock not included)</p>	<p><b>Bul. 800T/H Padlocking Cover</b> Guards against unauthorized operation. For non-illuminated push buttons, 2-position push-pull or twist-release units, and standard knob selector switches. When applying Cat. No. 800H-N140 on 2-position maintained push-pull units, cover locks only when the button is in depressed position. Padlocking cover includes blank legend plate for customer marking. <sup>(1)</sup></p>	800H-N140
 <p>Cat. No. 800T-NX446 (Padlock not included)</p>	<p><b>Bul. 800T 2- and 3-Position Non-illuminated Selector Switch Padlocking Attachment – Standard Knob</b> Padlocking guard for 2- and 3-position selector switches with standard knob operators only. Locks selector switch in any maintained position. <sup>(2)</sup></p>	800T-NX446

(1) A pre-marked legend plate is available. The words OPEN COVER TO OPERATE are on the front and PULL-TO-START-PUSH-TO-STOP are on the rear. To order legend plate only, specify Cat. No. 800H-W174L.











(2) Diameter of hasp is 11/32 in. (8.73 mm).

## Locking Attachments, Continued

	Description	Position	Cat. No.
 <p>Cat. No. 800H-N141R (Padlock not included)</p>	<p><b>Bul. 800H 2- and 3-Position Selector Switch with Padlocking Guards</b> Padlocking guard for 2- and 3-position selector switches with standard knob operators only.</p>	<p>Left Center Right</p>	<p>800H-N141L 800H-N141C 800H-N141R</p>
 <p>Cat. No. 800T-NX446A (Padlock not included)</p>	<p><b>Bul. 800T 4-Position Selector Switch Attachment – Standard Knob</b> Kit includes selector switch and guard (padlock not included). Padlocking guard for 4-position selector switches with standard knob operators only. Locks selector switch in any maintained position. <sup>(1)</sup></p>		<p>800T-NX446A</p>
	Description	Position	Cat. No.
 <p>Cat. No. 800H-N316J (Padlock not included)</p>	<p><b>Bul. 800T/H Non-Illuminated Selector Switch Padlocking Attachment</b> 2-, 3-, and 4-position selector switch padlocking attachments. Can be used to lock operators in a desired position. For 3-position selector switches, this device can also be used to lock out a left or right position as shown in the photo to the left.</p>	<p><b>For 2- and 3-position Selector Switches</b> Left Center Right Window Center through Right - Prevent Left Operation Window Center through Left - Prevent Right Operation</p> <p><b>For 4-position Selector Switches</b> Left (Pos. 1) Center Left (Pos. 2) Center Right (Pos. 3) Right (Pos. 4)</p>	<p>800T-N316L 800T-N316C 800T-N316R 800T-N316J 800T-N316K 800T-N317L 800T-N317CL 800T-N317CR 800T-N317R</p>
 <p>Cat. No. 800H-N4162L (Padlock not included)</p>	<p><b>Bul. 800T/H Illuminated Selector Switch Padlocking Attachment</b> 2- and 3-position selector switch padlocking attachments for illuminated selector switches. Stainless steel material</p>	<p><b>For 2-position Selector Switches</b> Left Right</p> <p><b>For 3-position Selector Switches</b> Left Center Right Window Center through Right - Prevent Left Operation Window Center through Left - Prevent Right Operation</p>	<p>800T-N4162L 800T-N4162R 800T-N4163L 800T-N4163C 800T-N4163R 800T-N4163J 800T-N4163K</p>



(1) Diameter of hasp is 11/32 in. (8.73 mm).

## Guards

	Description	Type	Cat. No.	
 <p>Cat. No. 800T-N13</p>	<b>Bul. 800T Push Button Guards</b> Momentary push button guards to reduce the risk of accidental operation.	1 in. guard for non-illuminated	800T-N13	
		1/2 in. guard for non-illuminated	800T-N143	
		1-1/2 in. guard for illuminated	800T-N93	
		1-1/2 in. guard for non-illuminated with locking attachment	800T-N39	
 <p>Cat. No. 800H-N152</p>	<b>Bul. 800H Illuminated Push Button Guard</b> This guard provides additional protection against accidental operation of the push button unit. 1-1/2 in. (38.1 mm) guard for illumination units.		800H-N152	
 <p>Cat. No. 800T-N226</p>	<b>Bul. 800T 18 mm Guard</b> Provides side protection for 18 mm pilot lights.		800T-N226	
 <p>Cat. No. 800H-N153</p>	<b>Bul. 800H Stainless Steel Guard</b> Used on non-illuminated push buttons that have protective boots as shown on <a href="#">page 47</a> .		800H-N153	
 <p>Cat. No. 800T-N129</p>	<b>Bul. 800T Mushroom Push Button Guards</b> Momentary mushroom guards for standard and jumbo mushroom push buttons. Reduces the risk of accidental operation.	Standard guard	800T-N129	
		Standard guard with set screw	800T-N165	
		Jumbo guard	800T-N151	
		Jumbo guard with set screw	800T-N154	
	<b>Description</b>	<b>Operator Head Size</b>	<b>Finish</b>	<b>Cat. No.</b>
 <p>Cat. Nos. 800T-N310 and 800T-NX1320</p>  <p>Cat. No. 800T-N310J</p>	<b>Bul. 800T/H Protective Guard</b> Stainless steel protective ring (Type 4/4X/13) for 2-position push-pull operators, illuminated, or non-illuminated. Often used in E-stop applications to avoid unintentional actuation of the E-stop operator.	40 mm (standard)	—	800T-N310
			Black	800T-NX1320
		60 mm (jumbo)	—	800T-N310J
		63 mm	—	800T-N310L
 <p>Cat. No. 800T-NGCY</p>	<b>Bul. 800T/H Protective Guard</b> Die-cast aluminum protective guard (Type 4/4X/13) for 2-position push-pull/twist release operators, illuminated, or non-illuminated. Often used in E-stop applications to avoid unintentional actuation of the E-stop operator.	40 mm (standard)	Yellow	800T-NGCY
 <p>Cat. No. 800T-N381</p>	<b>Bul. 800T/H Protective Guard</b> Die-cast aluminum protective guard (Type 4/4X/13) for 800T/H trigger action E-stop operators.	45 mm (standard)	Yellow	800T-N381
 <p>Cat. No. 800H-NTA60G</p>	<b>Bul. 800T/H Protective Guard</b> Yellow plastic protective guard (Type 4/4X/13) for 800T/H trigger action E-stop operators.	60/63 mm	—	800H-NTA60G
 <p>Cat. No. 800T-N339</p>	<b>Bul. 800T/H Ramp Guard</b> For Bul. 800T/800H 2- and 3-position illuminated and non-illuminated push-pull units. Standard-size button only (40 mm).			800T-N339

## Replacement Lamps

**Table 32 - Pilot Lights, Illuminated Push Buttons, Illuminated Push-Pull, Illuminated Push-Pull/Twist to Release, and Illuminated Selector Switches**

Lamp	Type	Current, Typical	Lamp Voltage	ANSI No.	Catalog Voltage Code	Cat. No.
 Incandescent	Full-voltage Transformer	150 mA/250 mA	6.3V AC	755/1866	6, 16, 26, 36, 46, 56, 76	800T-N65 <sup>(1)</sup>
	Full Voltage	80 mA	14V AC/DC	756	12	800T-N141 <sup>(1)</sup>
		70 mA	24V AC/DC	757	24	800T-N157 <sup>(1)</sup>
		50 mA	48V AC/DC	1835	48	800T-N365 <sup>(1)</sup>
	Full-voltage Resistor	22 mA	120V AC/DC	949	10, 11	800T-N169 <sup>(1)</sup>
	Flashing	150 mA	6V AC/DC	267	6	800T-N212 <sup>(1)</sup>
Dual-input Diode	57 mA	24V AC/DC	24 MB	24	800T-N180 <sup>(1)</sup>	
	21 mA	120V AC	90 MB	16	800T-N261 <sup>(1)</sup>	
 Neon	—	2 mA	120V AC/DC	B2A	10, 20	609-N9
Lamp	Type	Current, Typical	Lamp Voltage	Leakage Current	Code	Cat. No. <sup>(2)</sup>
 LED	Universal	13 mA @ 24V DC 8.5 mA @ 120V AC <sup>(3)</sup>	3V <sup>(4)</sup>	3 mA	2	800T-N376x <sup>(5)</sup>
	Transformer	60	6V	14 mA	16, 26, 46, 56	800T-N377x <sup>(5)</sup>

(1) Item is sold in multiples of five. Order quantity of five to receive package of five pieces.

(2) To complete the cat. no. replace the x with the first letter of the desired color: Green, Red, or White.

(3) Typical current consumption values that are indicated are relative to the input of the power module.

(4) Lamp is intended for use with power module Cat. No. 800TC-N374, which has an input voltage rating of 12 ...130V AC/DC.

(5) Lamp useful lifetime is 50,000 hours (L70 classification – light output will have diminished 70% at 50,000 hours).

**Table 33 - Legacy LED Lamps**

Lamp	Type	Current, Typical	Lamp Voltage	Leakage Current	Catalog Voltage Code	Cat. No. <sup>(1) (2)</sup>
 LED <sup>(3)</sup>	Full Voltage	16 mA	24...48V AC/DC	3 mA	24, 32, 48	800T-N419x
		12 mA	120...130V AC/DC	3 mA	10, 13	800T-N421x
	Flashing <sup>(4)</sup>	18 mA	24V AC/DC	—	—	800T-N319Fx

(1) In full-voltage applications, these lamps are intended to be used with power module Cat. No. 800T-N330.

(2) To complete the cat. no. replace the x with the first letter of the desired color: Green, Red, or White.

(3) All LEDs have an internal shunt resistor for use with solid-state outputs. LEDs do not illuminate below the listed leakage current.

(4) Flashing rate is 2 Hz.

**Table 34 - Cluster Pilot Lights**

Lamp	Type	Current, Typical	Lamp Voltage	Polarity	Cat. No.
 LED	Full Voltage	15 mA	12V AC/DC	Bi-polar	800T-N341W <sup>(1)</sup>
			28V AC/DC		800T-N80W <sup>(2)</sup>

(1) Can also be used for replacement in transformer type and 6V full voltage cluster pilot light units.

(2) For use with 24V AC/DC rated devices.

## Replacement Keys for Cylinder Lock 2-, 3-, and 4-position Selector Switches (Bulletin 800T only)

Cylinder Lock Key Option Code	Series Key Number	Cat. No.	Cylinder Lock Key Option Code	Series Key Number	Cat. No.
Blank (standard key)	D018 (standard key)	X-181170	15	T112 <sup>(1)</sup>	40269-087-01
03	D020 <sup>(2)</sup>	X-307922	16	T115 <sup>(1)</sup>	40269-087-02
04	D025 <sup>(2)</sup>	X-307923	17	T324 <sup>(1)</sup>	40269-087-03
05	D335 <sup>(2)</sup>	X-307924	18	T382 <sup>(1)</sup>	40269-087-04
06	D429 <sup>(2)</sup>	X-307925	19	T404 <sup>(1)</sup>	40269-087-05
07	D461 <sup>(2)</sup>	X-307926	20	T171 <sup>(1)</sup>	40269-087-06
08	D111 <sup>(2)</sup>	X-307927	21	T484 <sup>(1)</sup>	40269-087-07
09	D587 <sup>(2)</sup>	X-307928	22	T547 <sup>(1)</sup>	40269-087-08
10	D682 <sup>(2)</sup>	X-307929	23	T569 <sup>(1)</sup>	40269-087-09
11	D713 <sup>(2)</sup>	X-307930	24	T692 <sup>(1)</sup>	40269-087-10
12	D900 <sup>(2)</sup>	X-307931	25	T752 <sup>(1)</sup>	40269-087-11
13	D992 <sup>(2)</sup>	X-307932	26	T178 <sup>(1)</sup>	40269-087-12
14	D118 <sup>(2)</sup>	X-307933			

(1) Uses master key 15T, Cat. No. X-433359.

(2) Uses master key DM81, Cat. No. X-433358.

## Replacement Keys for Push Button Switches with Cylinder Locks (Bulletin 800T only)

Lock Key Option Code			Series Key Number	Cat. No.
Spring Bolt	Dead Bolt A	Dead Bolt B		
Blank (standard key)	Blank (standard key)	Blank (standard key)	E158 (standard key)	X-144218
44	32	20	E109	X-386233
45	33	21	E131	X-386234
46	34	22	E100	X-386235
47	35	23	E115	X-386236
48	36	24	E120	X-386237
49	37	25	E104	X-386238
50	38	26	E108	X-386239
51	39	27	E132	X-386240
52	40	28	E144	X-386241
53	41	29	E157	X-386242
54	42	30	E101	X-386243
55	43	31	E102	40274-250-01
66	61	56	E106	40274-250-07
67	62	57	E111	40274-250-02
68	63	58	E117	40274-250-14
69	64	59	E125	40274-250-21
70	65	60	E130	40274-250-26

## Legend Plates – Aluminum, Type 4/13 (Bulletin 800T)

### Blank/Custom Legend Plates



Legend Plate Color	Standard	Jumbo
	Cat. No.	Cat. No.
Gray	800T-X559	800T-X559J
Red	800T-X621	800T-X621J
Yellow	800T-X679	800T-X679J
Gray (with custom text)	800T-X559E	800T-X559JE
Red (with custom text)	800T-X621E	800T-X621JE
Yellow (with custom text)	800T-X679E	800T-X679JE

### Specialty Legend Plates

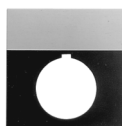

Legend Plate Color	Automotive	Half Round <sup>(1)</sup>
	Cat. No.	Cat. No.
Gray (blank)	800T-X700	800T-X59
Red (blank)	800T-X701	800T-X121
Gray (with custom text) <sup>(2)</sup>	–	800T-X59E
Red (with custom text) <sup>(2)</sup>	–	800T-X121E

(1) All half round legend plates must be ordered in quantities of 25.

(2) Include text with custom legends. See [Table 35](#) for guidelines.

**Table 35 - Custom Text Guidelines**

Legend Size	Number of Lines	Number of Characters per Line, Max
Standard	1 or 2 lines	14
Jumbo	5 lines	14
Automotive	4 lines	20

### Custom Legend Plates for 4-way Toggle and Cluster Pilot Lights

Legend Size	Cat. No. <sup>(1)</sup>	Color	Text Options <sup>(2)</sup>
Standard	800T-X619E	Aluminum (with custom text)	<ul style="list-style-type: none"> <li>• 2 lines of up to 14 characters on top</li> <li>• 1 line of up to 14 characters on bottom</li> <li>• 1 vertical line of up to 7 characters on left side</li> <li>• 1 vertical line of up to 7 characters on right side</li> </ul> <hr/> <ul style="list-style-type: none"> <li>• 1 vertical line of up to 9 characters on left side</li> <li>• 1 vertical line of up to 9 characters on right side</li> </ul>

(1) For blank toggle or cluster pilot legend, order Cat. No. 800T-X619.

(2) Rule sets listed are mutually exclusive; only one can be chosen.



## Specialty Legend Plates



Type	Start/Stop Legend Plates		Emergency Stop Legend Plates	
	Gray	Yellow	Yellow (Large Size)	Yellow IEC Ring
	Cat. No.	Cat. No.	Cat. No.	Cat. No.
Push-to-Stop Pull-to-Start or Push-to-Stop Twist or Pull Release	800T-X618	800T-X618Y	800T-X647Y	—
Blank	—	—	800T-X645Y	800T-X646
Custom	—	—	800T-X645YE	—
Emergency Stop	—	—	—	800T-X646EM <sup>(1)</sup>

(1) Does not comply with EN ISO 13850.

## Potentiometer Legend Plates

	Type	Cat. No.
	Potentiometer with graduated markings	800T-X609 <sup>(1)</sup>
	SPEED	800T-X608

(1) For graduated markings with a custom text, order Cat. No. 800T-X609E and specify up to two lines of text, 14 characters per line.

## 18 mm Legend Plates

	Type	Description	Cat. No.
 Cat. No. 800T-N515	Blank	Type A	800T-N515
		Type B	800T-N516
	With custom marking <sup>(1)</sup>	Type A with text	800T-N515E
		Type B with text	800T-N516E

(1) Text must be supplied. See [Table 36](#) for guidelines.

**Table 36 - Custom Text Guidelines**

Legend Type	Number of Lines	Maximum Number of Characters per Line
A	1	9
B	2	13



## Standard Legend Plates



Standard Legend Plate



Jumbo Legend Plate

Marking	Standard	Jumbo	Marking	Standard	Jumbo
	Cat. No.	Cat. No.		Cat. No.	Cat. No.
AUTO-OFF-HAND	800T-X501	800T-X501J	ON-OFF	800T-X622	800T-X622J
AUTO-MAN-OFF	800T-X625	800T-X625J	OPEN	800T-X531	800T-X531J
CLOSE	800T-X502	800T-X502J	OPEN-CLOSE	800T-X532	800T-X532J
CYCLE START	800T-X562	800T-X562J	OPEN-OFF-CLOSE	800T-X533	800T-X533J
DOWN	800T-X503	800T-X503J	OUT	800T-X534	800T-X534J
EMERG. STOP (Yellow) <sup>(1)</sup>	800T-X504Y	—	POWER ON	800T-X639	800T-X639J
EMERG. STOP (Red) <sup>(1)</sup>	800T-X504	800T-X504J	RAISE	800T-X535	800T-X535J
EMERGENCY STOP (Red) <sup>(1)</sup>	800T-X648	800T-X648J	RAISE-LOWER	800T-X536	800T-X536J
FAST	800T-X505	800T-X505J	RAISE-OFF-LOWER	800T-X537	800T-X537J
FEED START	800T-X566	800T-X566J	RESET	800T-X538	800T-X538J
FEED STOP	800T-X567	800T-X567J	REVERSE	800T-X539	800T-X539J
FOR.-REV.	800T-X506	800T-X506J	RUN	800T-X540	800T-X540J
FOR.-OFF-REV.	800T-X507	800T-X507J	RUN-INCH	800T-X634	800T-X634J
FORWARD	800T-X508	800T-X508J	RUN-JOG	800T-X541	800T-X541J
FOURTH SPEED	800T-X624	800T-X624J	SAFE-RUN	800T-X542	800T-X542J
FULL SPEED	800T-X509	800T-X509J	SECOND SPEED	800T-X543	800T-X543J
HAND-AUTO	800T-X510	800T-X510J	SPEED <sup>(2)</sup>	800T-X608	—
HAND-OFF-AUTO	800T-X511	800T-X511J	SLOW	800T-X544	800T-X544J
HIGH	800T-X512	800T-X512J	SLOW-FAST	800T-X545	800T-X545J
HIGH-LOW	800T-X513	800T-X513J	SLOW-OFF-FAST	800T-X546	800T-X546J
HIGH-OFF-LOW	800T-X514	800T-X514J	START	800T-X547	800T-X547J
IN	800T-X515	800T-X515J	START-JOG	800T-X548	800T-X548J
INCH	800T-X516	800T-X516J	START-STOP	800T-X549	800T-X549J
JOG	800T-X517	800T-X517J	STOP (Red)	800T-X550	800T-X550J
JOG FORWARD	800T-X518	800T-X518J	STOP-START	800T-X551	800T-X551J
JOG REVERSE	800T-X519	800T-X519J	SUMMER-OFF-WINTER	800T-X553	800T-X553J
JOG RUN	800T-X520	800T-X520J	SUMMER-WINTER	800T-X552	800T-X552J
JOG-SAFE-RUN	800T-X522	800T-X522J	TEST	800T-X554	800T-X554J
JOG-STOP-RUN	800T-X521	800T-X521J	THIRD SPEED	800T-X555	800T-X555J
LEFT-RIGHT	800T-X523	800T-X523J	UP	800T-X556	800T-X556J
LOCAL-REMOTE	800T-X638	800T-X638J	UP-DOWN	800T-X557	800T-X557J
LOW	800T-X524	800T-X524J	UP-OFF-DOWN	800T-X558	800T-X558J
LOW SPEED	800T-X525	800T-X525J	0 (Red)	800T-X640	800T-X640J
LOWER	800T-X526	800T-X526J	I	800T-X641	800T-X641J
OFF	800T-X527	800T-X527J	0 I	800T-X642	800T-X642J
OFF-COOLANT-ON	800T-X528	800T-X528J	I 0 II	800T-X643	800T-X643J
OFF-ON	800T-X529	800T-X529J			
ON	800T-X530	800T-X530J			

(1) These legend plates do not comply with EN ISO 13850.

(2) Potentiometer type with graduated markings.

## Legend Plates - Plastic, Type 4/4X (Bulletin 800H)

### Blank/Custom Legend Plates

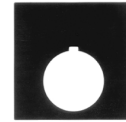

Type 4/4X

Legend Plate Color	Standard	Jumbo	Automotive
	Cat. No.	Cat. No.	Cat. No.
Gray (Blank)	800H-W100	800H-W100J	800H-W100A
Red (Blank)	800H-W300	800H-W300J	800H-W300A
White (Blank)	800H-W500	800H-W500J	800H-W500A
Yellow (Blank)	800H-W700	800H-W700J	800H-W700A
Gray (with Custom Text) <sup>(1)</sup>	800H-W100E	800H-W100JE	800H-W100AE
Red (with Custom Text) <sup>(1)</sup>	800H-W300E	800H-W300JE	800H-W300AE
White (with Custom Text) <sup>(1)</sup>	800H-W500E	800H-W500JE	800H-W500AE
Yellow (with Custom Text) <sup>(1)</sup>	800H-W700E	800H-W700JE	800H-W700AE

(1) Include text with custom legends. See [Table 37](#) for guidelines.

Table 37 - Custom Text Guidelines

Legend Size	Number of Lines	Maximum Number of Characters per Line
Standard	1 or 2 Lines of	13
Jumbo	5 Lines	13
Automotive	4 Lines	16

### Potentiometer Legend Plate

	Legend Marking	Cat. No.
	Graduated Markings Only	800H-W080
	SPEED	800H-W081
	Custom Legend with Graduated Marking	800H-W080E

### Start/Stop and Emergency Stop Legend Plates

			
Type	Start/Stop Legend Plates	Emergency Stop Legend Plates	
	Gray	Yellow (Large Size)	Yellow IEC Ring
	Cat. No.	Cat. No.	Cat. No.
Push-to-Stop Pull-to-Start	800H-W196	800H-W797A	—
Blank	—	800H-W700A	800H-W690
Custom	800H-W100E	800H-W700AE	—

## Standard Legend Plates

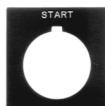

Gray Legend Plate (Type 4/4X)



White Legend Plate (Type 4/4X)

Marking	Gray Type 4/4X	White Type 4/4X	Marking	Gray Type 4/4X	White Type 4/4X	Marking	Gray Type 4/4X	White Type 4/4X
	Cat. No.	Cat. No.		Cat. No.	Cat. No.		Cat. No.	Cat. No.
AUTO OFF HAND	800H-W154	800H-W554	LEFT	800H-W004	800H-W404	RIGHT	800H-W005	800H-W405
AUTO MAN OFF	800H-W059	800H-W459	LEFT RIGHT	800H-W036	—	RUN	800H-W123	800H-W523
CLOSE	800H-W101	800H-W501	LOC OFF REMOTE	800H-W055	800H-W455	RUN INCH	800H-W037	—
CYCLE START	800H-W006	800H-W406	LOW	800H-W113	800H-W513	RUN JOG	800H-W032	—
CYCLE STOP (Red)	800H-W376	—	LOW HIGH	800H-W035	—	SAFE RUN	800H-W033	—
DECREASE	800H-W002	800H-W402	LOW OFF HIGH	800H-W056	—	SECOND SPEED	800H-W124	800H-W524
DOWN	800H-W102	800H-W502	LOW SPEED	800H-W114	800H-W514	SLOW	800H-W125	800H-W525
EMERG. STOP (Red) <sup>(1)</sup>	800H-W372	—	LOWER	800H-W115	800H-W515	SLOW FAST	800H-W136	800H-W536
			MAN AUTO	800H-W031	800H-W431	SLOW OFF FAST	800H-W157	800H-W557
EMERGENCY STOP (Red) <sup>(1)</sup>	800H-W373	—	MAN OFF AUTO	800H-W062	800H-W462	SPEED <sup>(2)</sup>	800H-W081	800H-W481
			MOTOR RUN	800H-W008	800H-W408	SPEED <sup>(2)</sup>	800H-W182	—
FAST	800H-W104	800H-W504	MOTOR STOP (Red)	800H-W375	—	START	800H-W126	800H-W526
FEED START	800H-W007	—				START JOG	800H-W138	800H-W538
FEED STOP (Red)	800H-W377	—	OFF	800H-W116	800H-W516	START JOG STOP	800H-W158	800H-W558
FOR. REV.	800H-W132	800H-W532	OFF COOLANT ON	800H-W052	800H-W452	START RUN STOP	800H-W054	—
FOR. OFF REV.	800H-W152	800H-W552				START STOP	800H-W137	800H-W537
FORWARD	800H-W105	800H-W505	OFF LOC REMOTE	800H-W061	—	STOP (Red)	800H-W371	—
FOURTH SPEED	800H-W010	—	OFF MAN AUTO	800H-W060	800H-W460	STOP RUN START	800H-W053	—
FULL SPEED	800H-W106	800H-W506	OFF ON	800H-W133	800H-W533	STOP START	800H-W038	800H-W438
HAND AUTO	800H-W131	800H-W531	ON	800H-W117	800H-W517	SUMMER OFF WINTER	800H-W159	800H-W559
HAND OFF AUTO	800H-W151	800H-W551	OPEN	800H-W118	800H-W518			
HIGH	800H-W107	800H-W507	OPEN CLOSE	800H-W134	800H-W534	SUMMER WINTER	800H-W139	800H-W539
HIGH LOW	800H-W030	—	OPEN OFF CLOSE	800H-W153	800H-W553			
HIGH LOW OFF	800H-W058	—	OUT	800H-W119	800H-W519	TEST	800H-W128	800H-W528
HIGH OFF LOW	800H-W155	800H-W555	POWER ON	800H-W001	800H-W401	THIRD SPEED	800H-W129	800H-W529
IN	800H-W108	800H-W508	PULL-TO-START	800H-W198	—	UP	800H-W009	800H-W409
INCH	800H-W109	800H-W509	PUSH-TO-STOP (Red)	800H-W378	—	UP DOWN	800H-W039	—
INCREASE	800H-W003	—				UP OFF DOWN	800H-W160	800H-W560
JOG	800H-W110	800H-W510	RAISE	800H-W120	800H-W520	0 (Red)	800H-W184	—
JOG FORWARD	800H-W111	800H-W511	RAISE LOWER	800H-W034	—	0 I	800H-W185	800H-W582
JOG REVERSE	800H-W112	800H-W512	RAISE OFF LOWER	800H-W156	800H-W556	I	800H-W181	800H-W581
JOG RUN	800H-W135	800H-W535				I 0 II	800H-W183	800H-W583
JOG SAFE RUN	800H-W051	—	RESET	800H-W121	800H-W521			
JOG STOP RUN	800H-W057	—	REVERSE	800H-W122	800H-W522			

(1) These legend plates do not comply with EN ISO 13850.

(2) Potentiometer type with graduated markings.

## Flip Lever Legend Plates (for use with Series D operators)

Marking	Gray (Type 4/4X)	Marking	Gray (Type 4/4X)	Marking	Gray (Type 4/4X)
	Cat. No.		Cat. No.		Cat. No.
Blank	800H-W200	LOW	800H-W213	RUN	800H-W223
Customer-specified <sup>(1)</sup>	800H-W200E	BAS	800H-W213F	EN MARCHE	800H-W223F
CLOSE	800H-W201	LOW SPEED	800H-W214	SECOND SPEED	800H-W224
FERMER	800H-W201F	VITESSE MIN	800H-W214F	VITESSE 2	800H-W224F
DOWN	800H-W202	LOWER	800H-W215	SLOW	800H-W225
DESCENDRE	800H-W202F	ABAISSER	800H-W215F	LENT	800H-W225F
FAST	800H-W204	OFF	800H-W216	START	800H-W226
RAPIDE	800H-W204F	ARRÊTER	800H-W216F	MARCHE	800H-W226F
FORWARD	800H-W205	ON	800H-W217	TEST	800H-W228
AVANT	800H-W205F	DÉMARRER	800H-W217F	ESSAI	800H-W228F
FULL SPEED	800H-W206	OPEN	800H-W218	THIRD SPEED	800H-W229
VITESSE MAX	800H-W206F	OUVRIR	800H-W218F	VITESSE 3	800H-W229F
HIGH	800H-W207	OUT	800H-W219	I	800H-W281
HAUT	800H-W207F	SORTIR	800H-W219F	O	800H-W284
IN	800H-W208	RAISE	800H-W220	LEFT	800H-W286
ENTRER	800H-W208F	ÉLEVER	800H-W220F	GAUCHE	800H-W286F
INCH	800H-W209	RESET	800H-W221	RIGHT	800H-W287
POUCE	800H-W209F	RÉARMER	800H-W221F	DROITE	800H-W287F
JOG	800H-W210	REVERSE	800H-W222	UP	800H-W288
À COUPS	800H-W210F	ARRIERE	800H-W222F	EN HAUT	800H-W288F

(1) 12 characters, max

Marking	Red (Type 4/4X)
	Cat. No.
Blank	800H-W400
Customer-specified <sup>(1)</sup>	800H-W400E
EMERG. STOP <sup>(2)</sup>	800H-W472
ARRÊT URGENT	800H-W472F
STOP	800H-W471
ARRET	800H-W471F
O	800H-W484

(1) 12 characters, max

(2) Does not comply with EN ISO 13850.

Dimensions in inches (millimeters). Dimensions are not intended to be used for manufacturing purposes.

## Mounting Instructions for Push Buttons with Shallow Blocks, Mini Blocks, Logic Reed Blocks, Sealed Switch Blocks, and Time Delay Blocks

[Figure 2](#) shows the minimum distance between centerlines when mounting Bulletin 800T/H controls either side by side, facing each other, or one above the other. When control units are mounted so that the contact block terminals face each other, the 2-1/4 in. (57.2 mm) dimension must be used to get proper electrical clearance. When control units are mounted so that the contact block terminals do not face each other, the 1-27/32 in. (46.8 mm) dimension can be used. (See footnotes following [Figure 2](#) for exceptions)

**Figure 2 - Minimum Distance Between Centerlines**

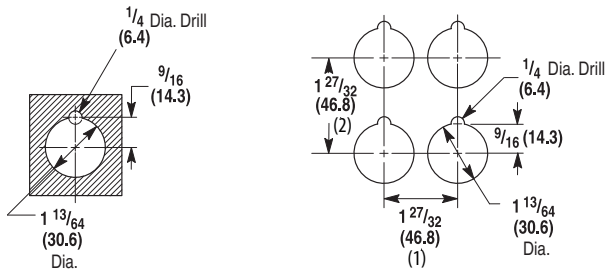

- (1) Change to 2-1/4 in. (57.2 mm) for transformer type pilot light, push-to-test pilot lights, illuminated selector switches, and all push-pull buttons.  
**Note:** Large legend plate requires minimum horizontal spacing of 2-15/32 in. (62.7 mm).
- (2) Vertical minimum spacing dimension changes for the following legend plates:  
 jumbo 2-15/32 in. (62.7 mm); large 2-7/16 in. (61.9 mm); cluster pilot light and 2-, 3-, 4-way switches 2-1/16 in. (52.4 mm).

## Typical Panel Cut-out

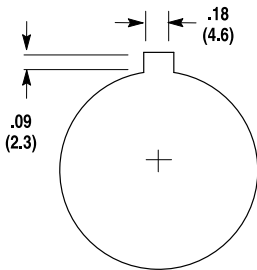

## Panel Thickness

Kits are shipped with three 1/16 in. (1.58 mm) gaskets. [Table 38](#) shows the number of washers that are required for various panel thicknesses.

**Table 38 - Washers Required**

Bulletin	1/16 in. (1.6 mm) (16 Gauge)	7/64 in. (2.8 mm) (12 Gauge) 9/64 in. (3.6 mm) (10 Gauge)	3/16 in. (4.8 mm) Panel	Thicker Than 3/16 in. (4.8 mm) Panel	Thicker Than 1/4 in. (6.4 mm) Panel
800T	3 washers	2 washers	1 washer	Counterbore to 3/16 in. (4.8 mm)	Counterbore to 3/16 in. (4.8 mm)
800H	4 washers	3 washers	2 washers	1 washer	Counterbore to 1/4 in. (6.4 mm)

Dimensions in inches (millimeters). Dimensions are not intended to be used for manufacturing purposes.

## 18 mm Small Pilot Lights

### Mounting Instructions

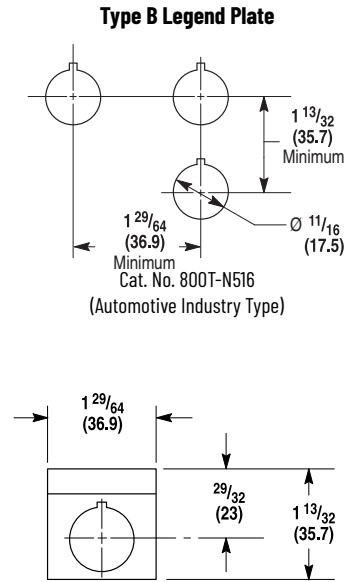
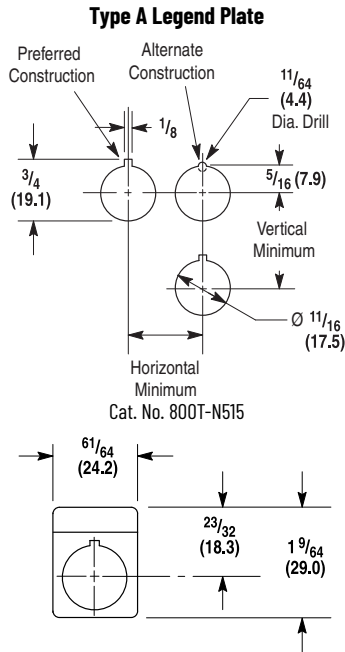

Device	Dimensions [in. (mm)]	
	Horizontal	Vertical
800T-PS, -PSD, -PST, -QS, -QST, and -RST	$\frac{31}{32}$ (24.6)	$1\text{-}\frac{5}{32}$ (29.4)
800T-PSDT	$1\text{-}\frac{3}{64}$ (26.6)	$1\text{-}\frac{15}{64}$ (31.4)

### Dimensions

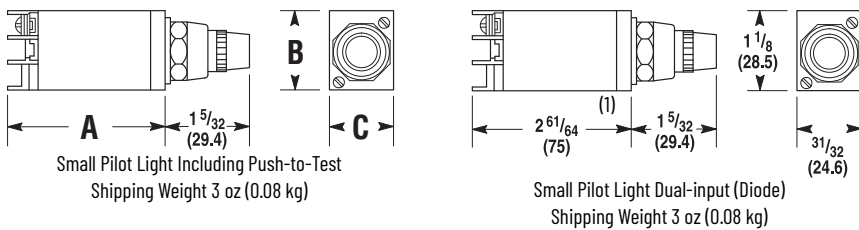

(1) dual-input transformer pilot light dimension is  $2\text{-}\frac{31}{32}$  in. (75.4 mm).

Device	Dimensions [in. (mm)]		
	A	B	C
800T-PS, -PSD, -PST, -QS, -QST, and -RST	$2\text{-}\frac{1}{4}$ (57.2)	$1\text{-}\frac{1}{16}$ (27)	$\frac{27}{32}$ (21.4)
800T-PSDT	$2\text{-}\frac{61}{64}$ (75)	$1\text{-}\frac{15}{64}$ (31.4)	$\frac{31}{32}$ (24.6)

Dimensions in inches (millimeters). Dimensions are not intended to be used for manufacturing purposes.

## Legend Plate Dimensions (Bulletin 800T Only)

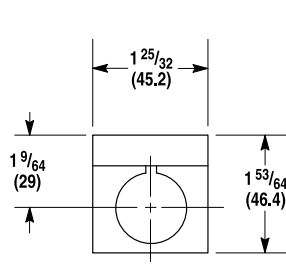

Standard Legend Plate

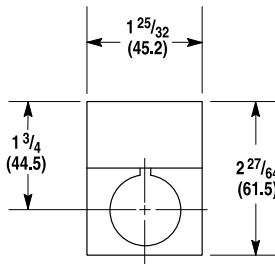

Jumbo Legend Plate

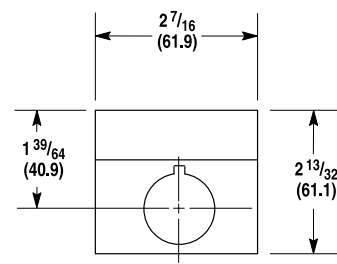

Large Legend Plate  
(Automotive Industry Type)

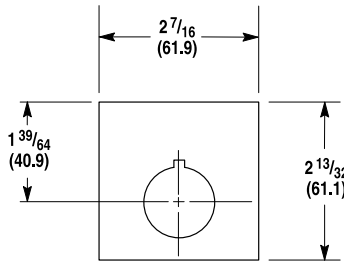

Large Size Push-pull/Twist Legend Plate  
Cat. No. 800T-X647<sup>(1)</sup>

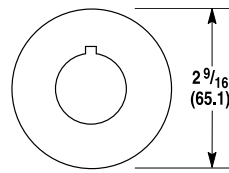

Round  
Cat. No. 800T-X646<sup>(1)</sup>

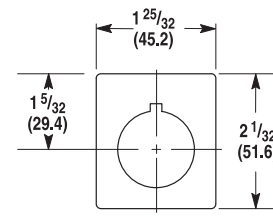

Cluster Pilot Light and 2-3-4 Way Switch  
Silver Legend Plate  
Cat. No. 800T-X619

(1) For panel mounting only. Not for use with Allen-Bradley® enclosures.

## Legend Plate Dimensions (Bulletin 800H Only)

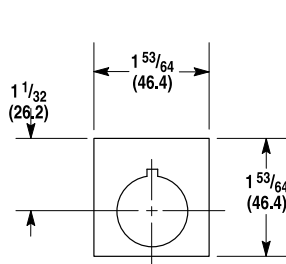

Type 4/4X  
Standard Legend Plate

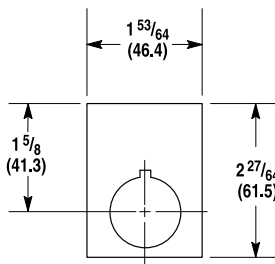

Type 4/4X  
Jumbo Legend Plate

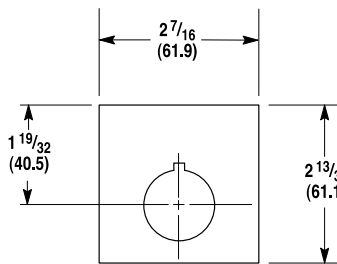

Type 4/4X  
Large Legend Plate  
(Automotive Industry Type)

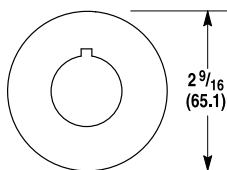

Type 4/4X  
Round

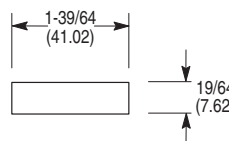

Type 4/4X  
Standard Legend Plate  
(Flip Lever Operators)

Dimensions in inches (millimeters). Dimensions are not intended to be used for manufacturing purposes.

## Contact Blocks (Bulletin 800T Only)

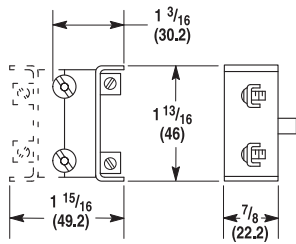

Mini Contact Block  
7/8 (22.2) Deep

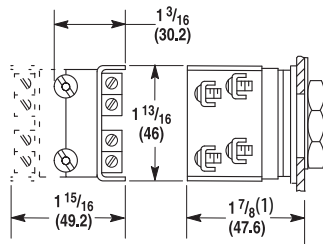

Shallow, PenTUFF™, and Logic Reed Contact Blocks  
1-7/8 (28.6) Deep

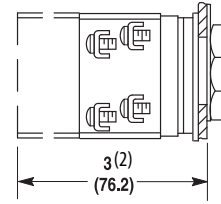

Tandem Mounting  
(two shallow contact blocks stacked)

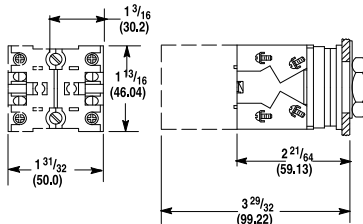

Stackable Sealed Switch Block  
1 5/8 (40.1) Deep

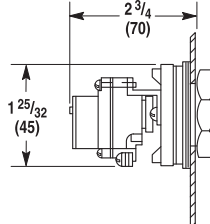

Time Delay Contact Block  
(For Push Buttons Only)

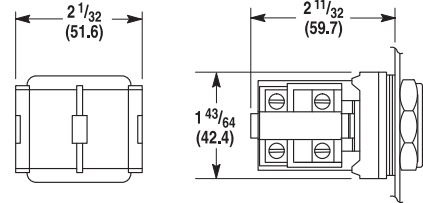

Snap Action Contact Block (For Push Button Only)

- 1) Dimension that is shown is for push buttons. Selector switch dimension is 2-1/32 in. (51.6 mm).
- 2) Dimension that is shown is for push buttons. Selector switch dimension is 3-5/32 in. (80.2 mm).

## Contact Blocks (Bulletin 800H Only)

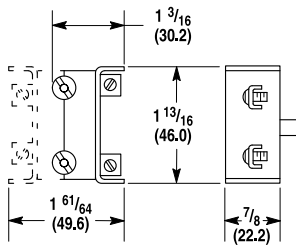

Mini Contact Block

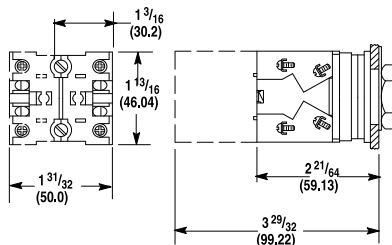

Stackable Sealed Switch Block  
1 5/8 (40.1) Deep

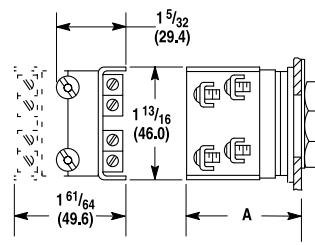

Shallow, PenTUFF, and Logic Reed Contact Blocks

Dimension (1)	Momentary Push Button [in. (mm)]	Maintained Push Button [in. (mm)]	Selector Switch [in. (mm)]
A	2 (50.8)	2 (50.8)	1-29/32 (48.4)

(1) Operator Extension Behind Panel – When mounted with thrust washer, trim washer, or notched legend plate and correct number of rubber washers.

## Push Buttons and Switches (Bulletin 800T Only)

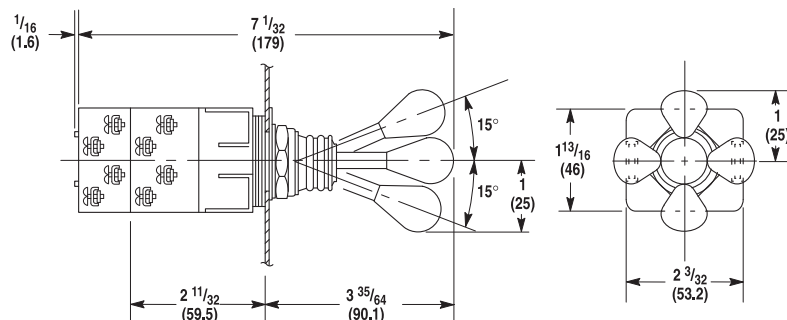

2-3-4 Way Switch  
Shipping Weight with Two Contact Blocks 6 oz (0.17 kg), with Four Contact Blocks 8-1/2 oz (0.24 kg)

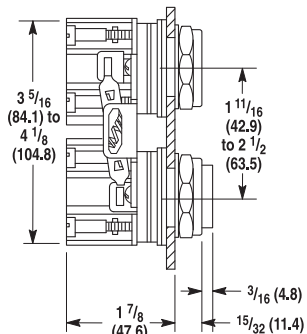

Mechanically Interlocked Maintained Contact Push Button  
Shipping Weight 1 lb (0.45 kg)



Dimensions in inches (millimeters). Dimensions are not intended to be used for manufacturing purposes.

## Push Buttons and Pilot Lights

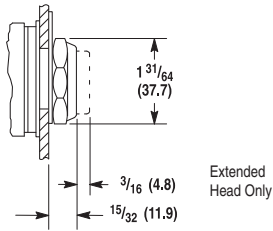

Flush and Extended Head Push Button  
Shipping Weight 5-1/2 oz (0.15 kg)

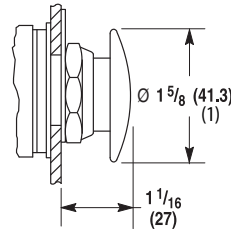

Mushroom Head Push Button  
Shipping Weight 7-1/2 oz (0.21 kg)

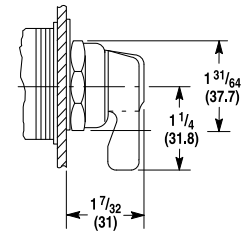

Non-illuminated Knob Lever and Standard Knob Selector Switch  
Shipping Weight 6 oz (0.17 kg)

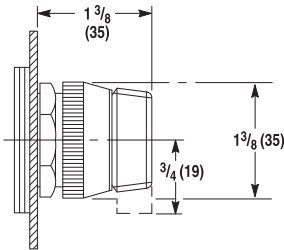

Illuminated Knob Lever and Standard Knob Selector Switch  
Shipping Weight 6 oz (0.17 kg)

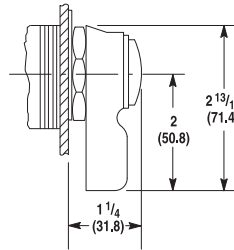

Wing Lever Selector Switch  
Shipping Weight 8 oz (0.22 kg)

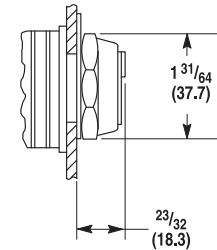

Coin Slot Selector Switch  
Shipping Weight 6 oz (0.17 kg)

(1) Except jumbo, which is 2-1/4 (57.2).

## Operator Extension in Front of Panel (Bulletin 800T Only)

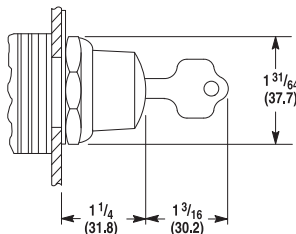

Key Operated Selector Switch  
Shipping Weight 12 oz (0.34 kg)

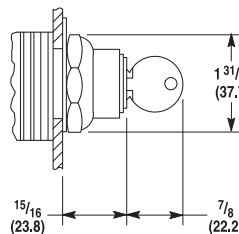

Push Button with Cylinder Lock  
Shipping Weight 12 oz (0.34 kg)

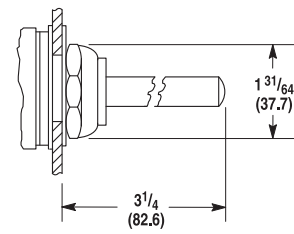

Wobble Stick  
Shipping Weight 9 oz (0.25 kg)

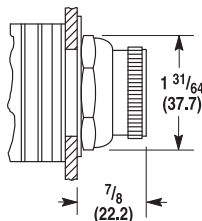

Selector Push Button  
Shipping Weight 6 oz (0.17 kg)

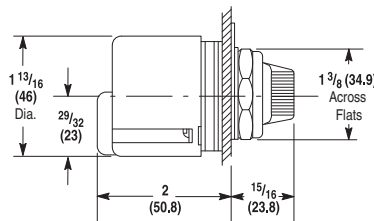

Type J Potentiometer Unit  
Shipping Weight 4 oz (0.11 kg)

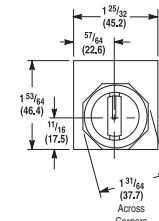

Dimensions in inches (millimeters). Dimensions are not intended to be used for manufacturing purposes.

## Push Buttons and Switches (Bulletin 800H Only)

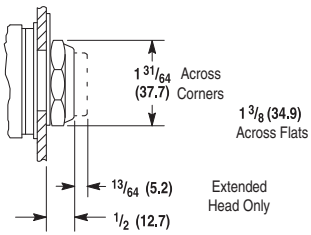

Bootless Flush and Extended Head Momentary Contact Push Button  
Shipping Weight: 5-1/2 oz (0.16 kg)

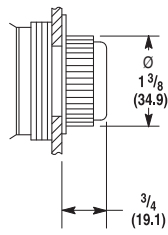

Booted Flush and Extended Head Momentary Contact Push Button  
Shipping Weight: 5-1/2 oz (0.16 kg)

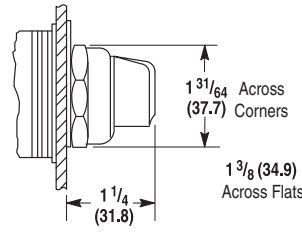

Standard Knob Selector Switch Non-illuminated  
Shipping Weight: 6 oz (0.17 kg)

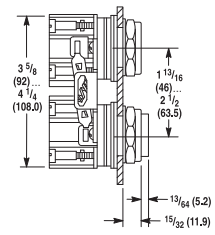

Bootless Maintained Contact Push Buttons

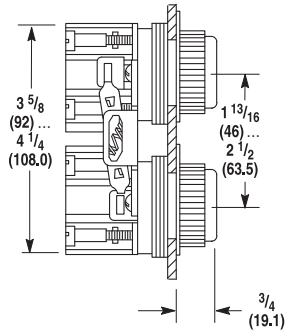

Booted Maintained Contact Push Buttons  
Shipping Weight: 1 lb (0.45 kg)

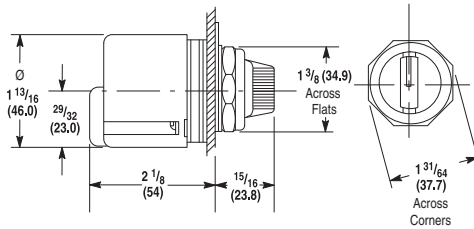

Type J Potentiometer Unit  
Shipping Weight: 7 oz (0.20 kg)

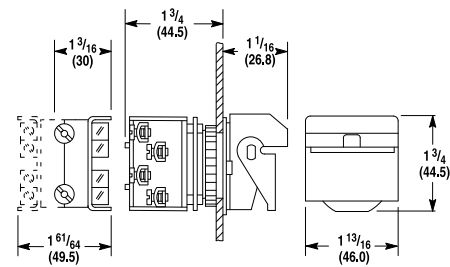

Type 4 Flip Lever  
Shipping Weight: 8 oz (0.14 kg)

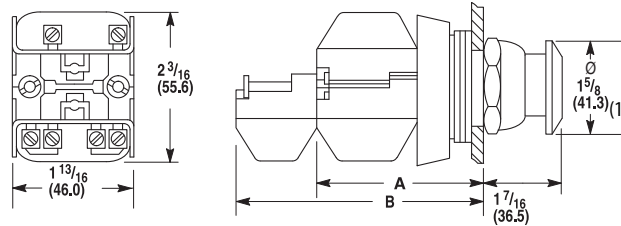

Mushroom Head – Maintained and Momentary

(1) Jumbo versions are 2-1/4 (57.2).

### Non-illuminated Mushroom and Push-pull Push Buttons

Cat. No. Suffix	Description	Dimensions [in. (mm)]	Shipping Weights [oz (kg)]
D4	One shallow block	A 2-1/32 (51.6)	5 (0.14)
A1, A5, and A7	Two shallow blocks	A 2-1/32 (51.6)	6 (0.17)
B6	Two shallow blocks and two mini blocks	B 2-7/8 (73.0)	8 (0.22)

## Break-glass Station

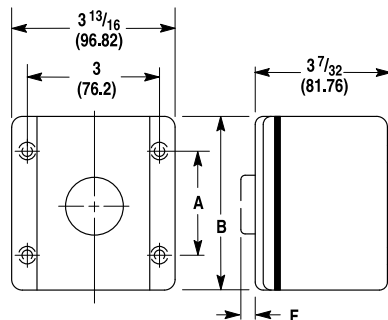

A = 2 3/4 (69.85)  
B = 4 3/16 (106.38)  
F = 9/16 (14.28)

Dimensions in inches (millimeters). Dimensions are not intended to be used for manufacturing purposes.

## Pilot Light and Illuminated Devices (Bulletin 800T Only)

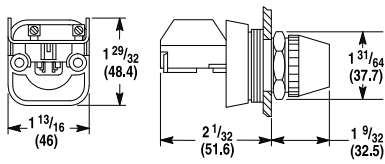

Full-voltage, Neon, and Dual-input Pilot Light  
Shipping Weight 5 oz (0.14 kg)

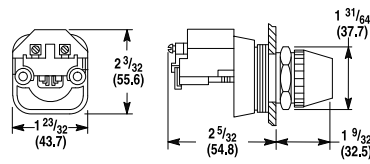

Transformer Type Pilot Light  
Shipping Weight 8 oz (0.22 kg)

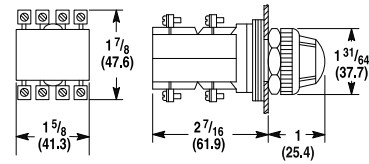

Cluster Pilot Light  
Shipping Weight 12 oz (0.34 kg)

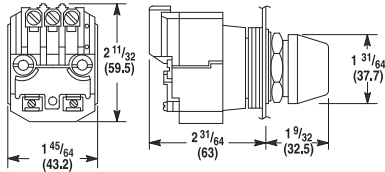

Dual-input Transformer  
Type Pilot Light

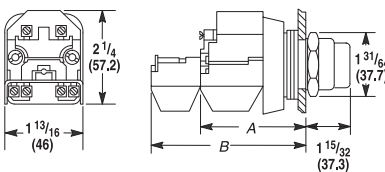

Transformer Type  
(Push-to-test Pilot Light and Illuminated Push Button)

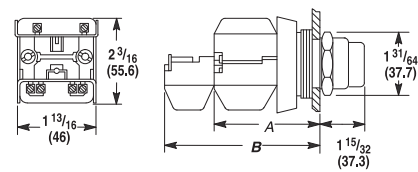

Full-voltage, Neon, and Dual-input Type  
(Push-to-test Pilot Light and Illuminated Push Button)

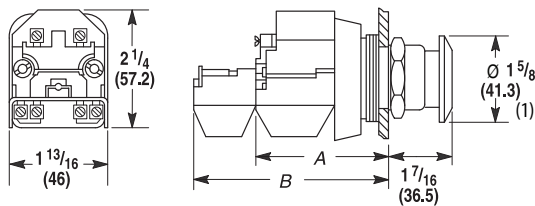

Push-pull and Twist or Pull Release Units  
(Transformer Type Illuminated)

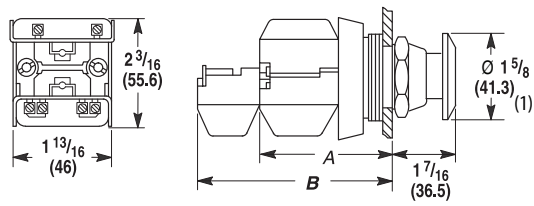

Push-pull and Twist or Pull Release Units  
(Full-voltage, Neon, and Dual-input Illuminated and All Non-illuminated)

(1) Jumbo mushroom versions are 2-1/4 in. (57.2 mm) diameter.

Push-to-test Pilot Lights Illuminated Push Buttons and Illuminated Push-pull Buttons							Non-illuminated Push-pull Buttons					
Cat. No. Suffix	Description	Transformer Type		Full-voltage or Neon Type		Cat. No. Suffix	Description	Transformer Type				
		Dim.	Ship. Wt.	Dim.	Ship. Wt.			Dim.	Ship. Wt.			
D4	Transformer or Terminal Module and One Shallow Contact Block	A	2-5/32 (54.8) (1)	9 oz. (0.25 kg)	A	2-1/32 (51.6)	7 oz. (0.25 kg)	D4	One Shallow Contact Block	A	2-1/32 (51.6)	5 oz. (0.14 kg)
A1 and A7	Transformer or Terminal Module and One Shallow Block and One Mini Contact Block	B	2-7/8 (73)	10 oz. (0.28 kg)	B	2-7/8 (73)	8 oz. (0.22 kg)	A4, A5, and A7	Two Shallow Contact Blocks	A	2-1/32 (51.6)	6 oz. (0.17 kg)
								B6	Two Shallow Blocks and Two Mini Contact Blocks	B	2-7/8 (73)	8 oz. (0.22 kg)

(1) Dual-input type pilot light dimension is 2-13/32 in. (61.1 mm).

Dimensions in inches (millimeters). Dimensions are not intended to be used for manufacturing purposes.

## Push-to-test Pilot Light and Illuminated Devices (Bulletin 800H Only)

Figure 3 - Transformer, Full Voltage, and Dual-input Diode Type

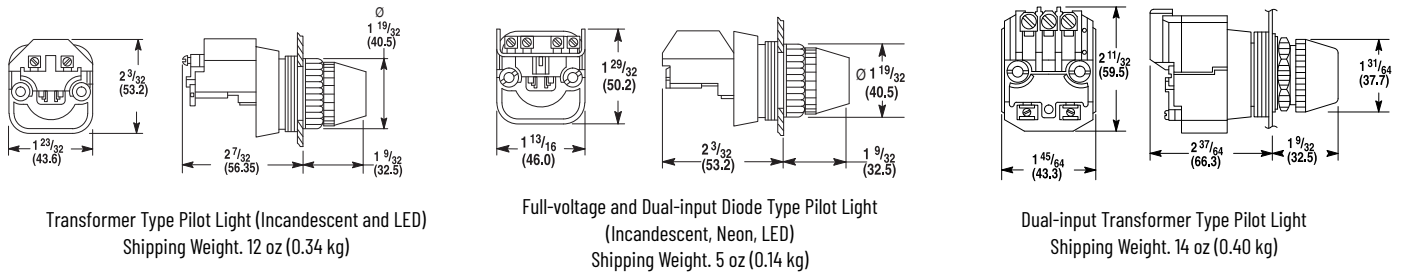
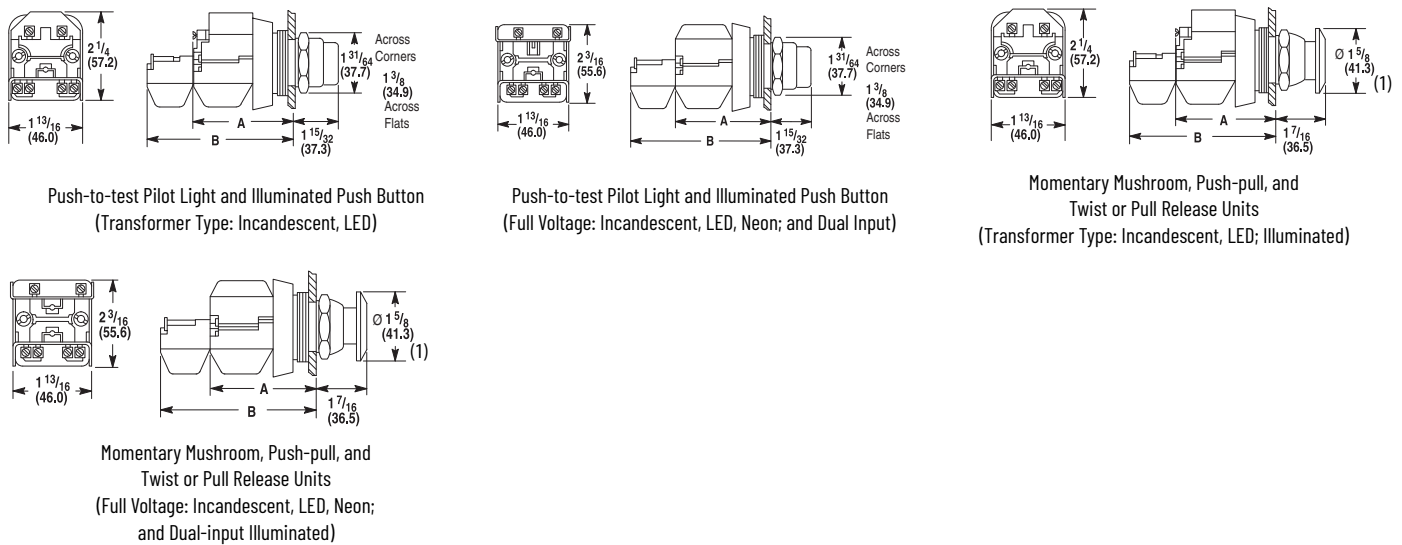

Figure 4 - Push-to-test Pilot Lights – Illuminated Push Buttons, Illuminated Push-pull and Twist, or Pull Release Push Buttons



(1) Jumbo mushroom versions are 2-1/4 in. (57.2 mm) diameter.

### Push-to-test Pilot Lights Illuminated Push Buttons, Illuminated Push-pull and Twist, or Pull Release Push Buttons

Cat. No. Suffix	Description	Transformer Type		Full-voltage or Neon Type		
		Dimension	Shipping Weight	Dimension	Shipping Weight	
D4	Transformer or Terminal Module and One Shallow Contact Block	A	2-5/32 (54.8) <sup>(1)</sup>	A	2-1/32 (51.6) <sup>(2)</sup>	7 oz. (0.20 kg)
A1 and A7	Transformer or Terminal Module, One Shallow Block and One Mini Contact Block	B	2-7/8 (73)	B	2-7/8 (73)	8 oz. (0.22 kg)

(1) Dual-input type pilot light dimension is 2-13/32 in. (61.1 mm).

(2) Dual-input type pilot light dimension is 2-9/32 in. (57.9 mm).

Dimensions in inches (millimeters). Dimensions are not intended to be used for manufacturing purposes.

## Accessories

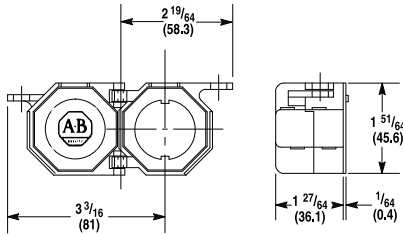

Push Button Padlocking Cover  
(not for use with Jumbo Mushroom Head devices)  
Shipping Weight 1 oz (0.03 kg)

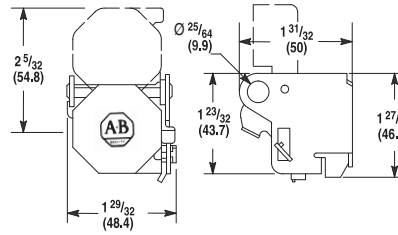

Selector Switch and Potentiometer  
Unit Padlocking Cover

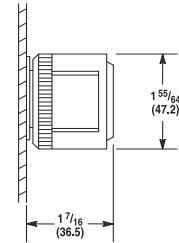

Protective Ring and  
Push-pull Illuminated  
or Non-illuminated Operators

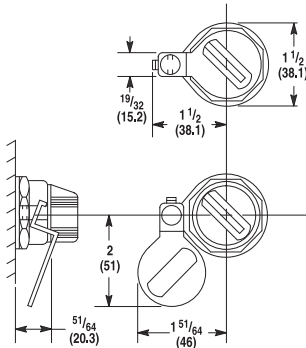

Selector Switch Padlocking Attachment

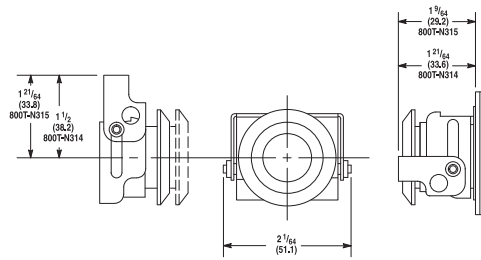

Push-pull Padlocking Attachment and  
Metal Mushroom Push Button Padlocking Attachment

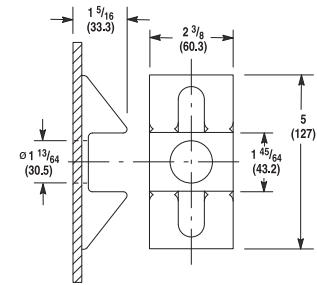

Ramp Guard for Push-pull Illuminated or  
Non-illuminated Operators

## Accessories (Bulletin 800H Only)

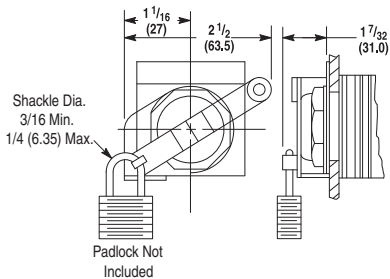

Locking Attachment for Extended,  
Non-illuminated Push Buttons

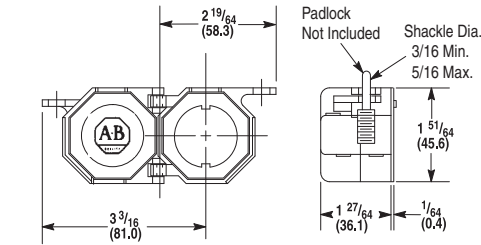

800H-N140 Locking Cover for 2-position Non-illuminated Maintained  
Twist or Pull Release and Standard Knob Selector Switch  
(1-5/8 (41.3) Mushroom Head only)

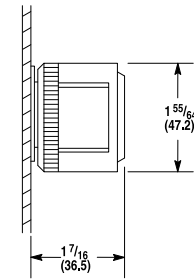

Protective Ring for 2-position  
Push-pull/Twist Illuminated  
or Non-illuminated Operators

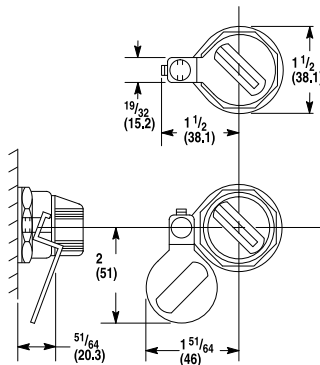

Non-illuminated Selector Switch  
Padlocking Attachment

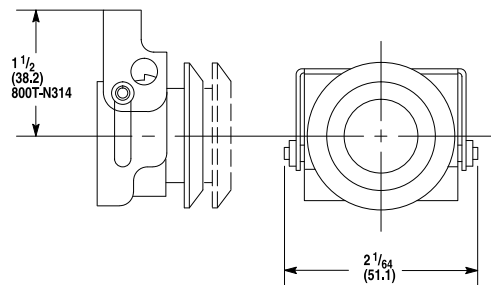

Push-pull/Twist Padlocking Attachment

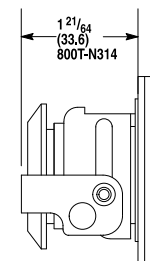

Dimensions in inches (millimeters). Dimensions are not intended to be used for manufacturing purposes.

## Die Cast Enclosures (Bulletin 800T Only)

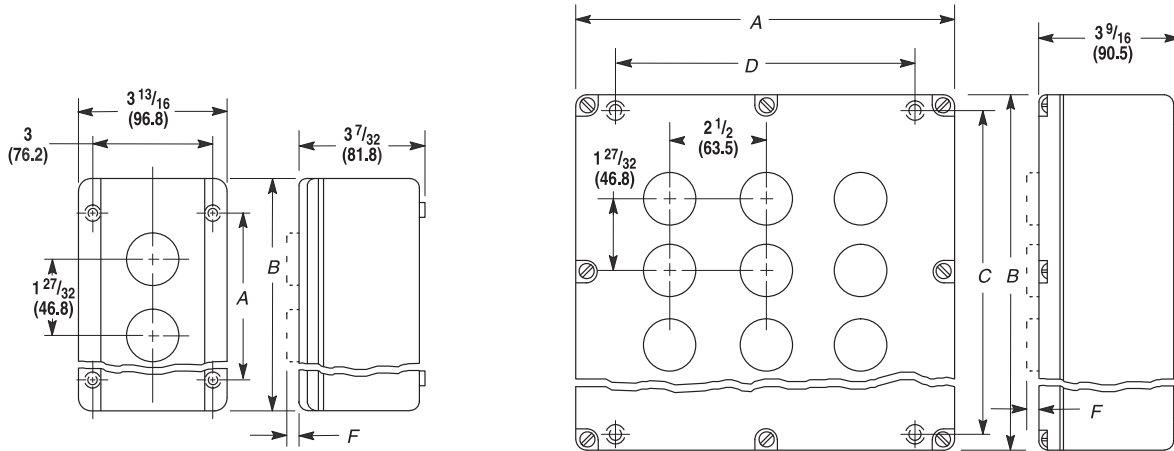

Enclosure Dimensions (1)					
Dim.	No. of Units				
	1	2	3	4	6
A	2-3/4 (69.9)	4-1/2 (114.3)	6-1/4 (158.8)	8 (203.2)	12-1/8 (308)
B	4-3/16 (106.4)	5-7/8 (144.2)	7-9/16 (192.1)	9-1/2 (241.3)	13-1/2 (342.4)

Enclosure Dimensions (2)				
Dim.	No. of Units			
	6	9	12	16
A	7-1/4 (184.2)	9-3/4 (247.7)	9-3/4 (247.7)	12-1/2 (317.5)
B	9 (228.6)	9 (228.6)	11 (279.4)	11 (279.4)
C	8-1/4 (209.6)	8-1/4 (209.6)	10-1/8 (257.2)	10-1/8 (257.2)
D	5-3/8 (136.5)	7-7/8 (200)	7-7/8 (200)	10-5/8 (269.9)

(1) Mounting holes (4) – Screw shaft 13/64 in. (5.16 mm) max diameter.  
 (2) Mounting holes (4) – Screw shaft 7/32 in. (5.56 mm) max diameter.

Table 39 - F Dimension

Type of Unit		F Dimension
Push Buttons	Flush Extended	15/32 (11.9)
	Extended	21/32 (16.7)
	Mushroom	1 (25.4)
	Selector	7/8 (22.2)
	Cylinder Lock	1-13/16 (46)
Selector Switches	Standard	1-7/32 (30.9)
	Cylinder Lock	2-7/16 (61.9)
	Coin Slot	3/4 (19.1)
Pilot Light		1-1/8 (28.6)
Potentiometers		1-1/16 (27)

Table 40 - Conduit Openings

General Class	Description	No. of Units (1)						
		1...4	6	9	12	16	20	25
Surface-mounted enclosure	Die cast	3/4 in. 14 N.P.T.	1 in. 11-1/2 N.P.T.	1 in. 11-1/2 N.P.T.	1 in. 11-1/2 N.P.T.	1-1/2 in. 11-1/2 N.P.T.	–	–

(1) Number of units that can be mounted in the enclosure.

Dimensions in inches (millimeters). Dimensions are not intended to be used for manufacturing purposes.

## Enclosures (Bulletin 800T Only)

### Pendant Stations

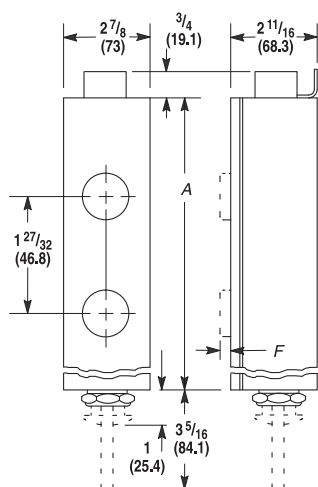

Table 41 - Dimension A

No. of Units	Dimension A
2	5-13/16 (147.6)
3	7-21/32 (194.5)
4	9-1/2 (241.3)
5	11-11/32 (288.1)
6	13-3/16 (335)

Table 42 - Dimension F

Type of Unit		Dimension F
Push buttons	Flush extended	15/32 (11.9)
	Extended	21/32 (16.7)
	Mushroom	1 (25.4)
	Selector	7/8 (22.2)
	Cylinder lock	1-13/16 (46)
Selector switches	Standard	1-7/32 (30.9)
	Cylinder lock	2-7/16 (61.9)
	Coin slot	3/4 (19.1)
Pilot light		1-1/8 (28.6)
Potentiometers		1-1/16 (27)

Table 43 - Conduit Openings

General Class	Description	Number of Units <sup>(1)</sup>	
		2...5	6
Pendant-type enclosure	Opening in bottom	1 (25.4) conduit hub	1-1/4 (31.8) conduit hub
	Opening in cover	1 (25.4) conduit hub	1-1/4 (31.8) conduit hub

(1) Number of units that can be mounted in the enclosure.

Dimensions in inches (millimeters). Dimensions are not intended to be used for manufacturing purposes.

## Enclosures (Bulletin 800H Only)

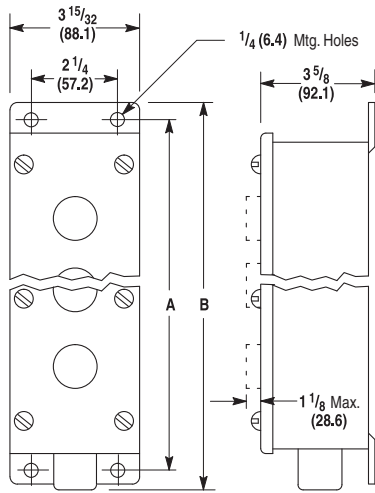

Type 4/4X/13 Stainless Steel  
Watertight, Oiltight, Corrosion-resistant Enclosure

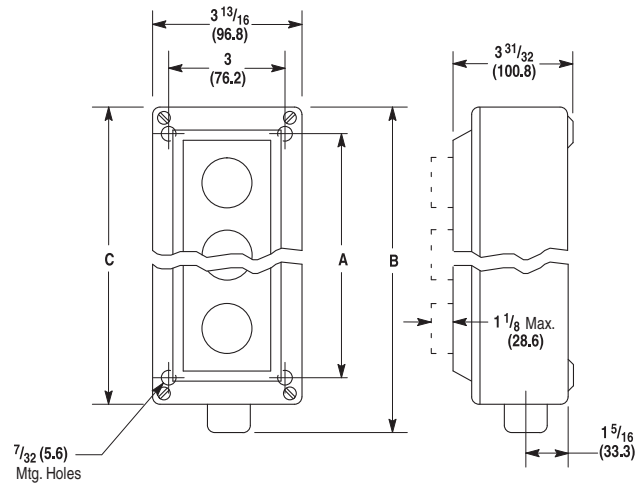

Type 4/4X/13 Rosite Glass Polyester  
Watertight, Oiltight, Corrosion-resistant Enclosure

Dimension	Type 4/4X/13 Stainless Steel							
	Number of Units							
	1	2	3	4	5	6	7	8
A	5-5/32 (131)	7 (177.8)	8-27/32 (224.6)	10-11/16 (271.5)	12-17/32 (318.3)	14-3/8 (365.1)	16-7/32 (412)	18-1/16 (458.8)
B	6-13/32 (162.7)	8-1/4 (209.6)	10-1/8 (257.2)	11-31/32 (304)	14-1/32 (356.4)	15-7/8 (403.2)	17-3/4 (450.8)	19-19/32 (497.7)
C	-				-			
Conduit knockout size	-				-			
Pipe tap size	3/4 (19.1)				1 (25.4)			
Approximate shipping weight [lb (kg)]	2-3/4 (1.3)	3-3/4 (1.7)	4-3/4 (2.2)	5-3/4 (2.6)	6-3/4 (3.1)	7-3/4 (3.5)	8-3/4 (4)	9-3/4 (4.4)

Dimension	Type 4/4X/13 Rosite					
	Number of Units					
	1	2	3	4	5	6
A	4-1/2 (114.3)	4-1/2 (114.3)	6-1/4 (158.8)	8 (203.2)	12-1/8 (308)	12-1/8 (308)
B	7-1/32 (178.6)	7-1/32 (178.6)	8-23/32 (221.5)	10-21/32 (270.7)	14-7/8 (377.8)	14-7/8 (377.8)
C	5-7/8 (149.2)	5-7/8 (149.2)	7-9/16 (192)	9-1/2 (241.8)	13-1/2 (342.9)	13-1/2 (342.9)
Conduit knockout size	-			-		
Pipe tap size	3/4 (19.1)			1 (25.4)		
Approximate shipping weight [lb (kg)]	2 (0.9)	2 (0.9)	2-1/2 (1.1)	3 (1.4)	4 (1.8)	4 (1.8)



Dimensions in inches (millimeters). Dimensions are not intended to be used for manufacturing purposes.

## Enclosures (Bulletin 800H Only), Continued

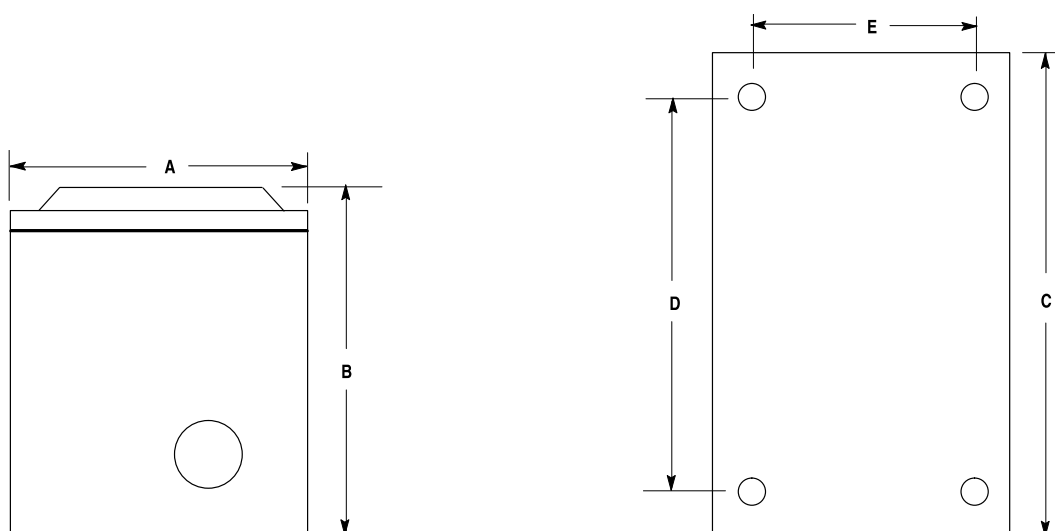

Dimension	Fiberglass Type 4/4X/12/13		
	Number of Units		
	1	2	3
A x B x C	4-1/2 x 5-3/16 x 6 (114.3 x 131.8 x 152.4)	4-1/2 x 5-3/16 x 8 (114.3 x 131.8 x 203.2)	6-1/2 x 5-7/16 x 8 (165.1 x 138.1 x 203.2)
D x E	4-3/4 x 2 (120.7 x 50.8)	6-3/4 x 2 (171.5 x 50.8)	6-3/4 x 4 (171.5 x 101.6)
Conduit knockout size	3/4 (19.1)	1 (25.4)	1 (25.4)
Approximate shipping weight [lb (kg)]	2 (0.9)	1/4 (1.0)	3 (1.4)

# General-purpose Enclosures



<b>Attribute</b>	<b>800H-1HZ4C (1-hole), 800H-2HZ4C (2-hole), 800H-3HZ4C (3-hole), 800H-4HZ4C (4-hole)</b>
Description	Push button enclosure
Features	Designed to house 30.5 mm (Bulletin 800H) push buttons (available in gray or yellow colors)
Degree of protection	Type 1, 4, 4X, 12, 13 IP66 Indoor/outdoor
Storage temperature range	-40...+75 °C (-40...+158 °F)
Operating temperature range	-40...+55 °C (-40...+131 °F)
Material	
Enclosure	Enclosure thermoplastic polyester blend, UL94-5VA
Gasket	Foam-in-place polyurethane
Standards	UL 508A and CSA C22.2, No. 14
Certifications	c-UL-us, CE

## Approximate Dimensions

Dimensions are shown in millimeters (inches). Dimensions are not intended to be used for manufacturing purposes.

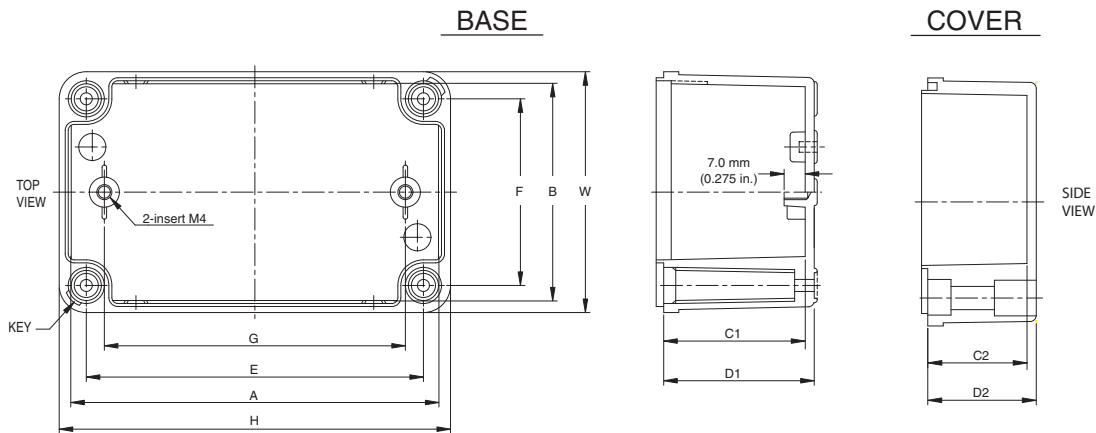
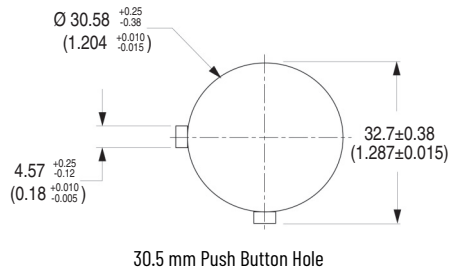

**Table 44 - General-purpose Enclosure Dimensions [in. (mm)]**

Cat. No.	Type	Overall Dimension				Inside Dimension				Enclosure Mounting Dimension		Mounting Plate Mounting Dimension
		H	W	D1	D2	A	B	C1	C2	E	F	G
800H-1HZ4...	1-hole	110 (4.33)	80 (3.15)	50 (1.97)	20 (0.79)	104 (4.09)	74 (2.91)	46.5 (1.83)	16.5 (0.65)	92 (3.62)	62 (2.44)	80 (3.15)
800H-2HZ4...	2-hole	130 (5.12)	80 (3.15)	50 (1.97)	35 (1.38)	120 (4.72)	70 (2.76)	46.5 (1.83)	31.5 (1.24)	112 (4.41)	62 (2.44)	100 (3.94)
800H-3HZ4...	3-hole	180 (7.09)	80 (3.15)	50 (1.97)	35 (1.38)	170 (6.69)	70 (2.76)	46.5 (1.83)	31.5 (1.24)	162 (6.38)	62 (2.44)	150 (5.91)
800H-4HZ4...	4-hole	250 (9.84)	80 (3.15)	50 (1.97)	35 (1.38)	240 (9.45)	70 (2.76)	46.5 (1.83)	31.5 (1.24)	232 (9.13)	62 (2.44)	220 (8.66)

Dimensions are shown in millimeters (inches). Dimensions are not intended to be used for manufacturing purposes.

## Push Button Hole



## Push Button Hole Spacing

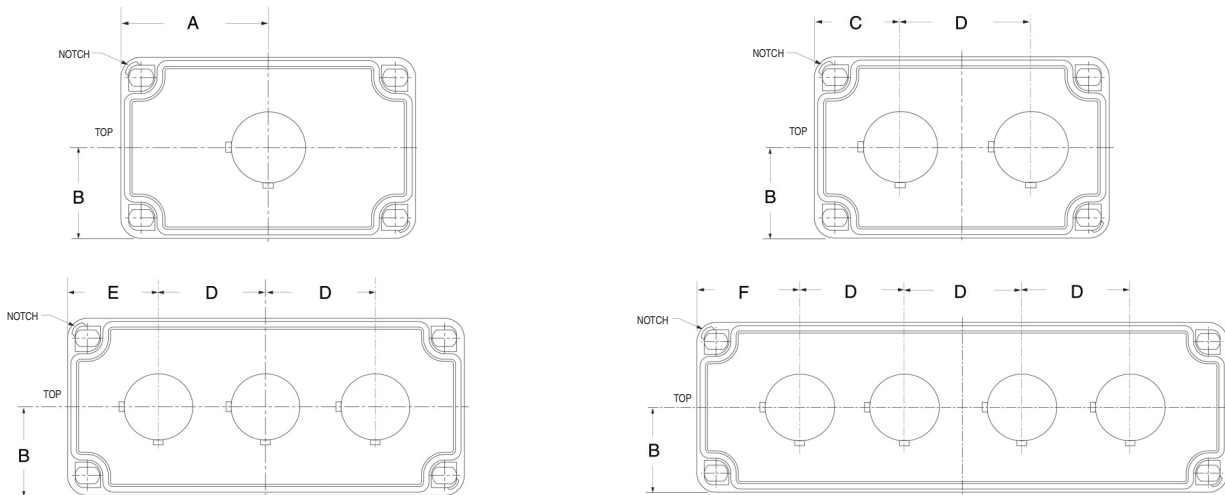

Cat. No.	Type	A	B	C	D	E	F
800H-1HZ4C	1-hole	55±.216 (2.165±0.0085)	40±0.5 (1.57±0.020)	—	46.8±0.191 (1.843±0.0075)	—	—
800H-2HZ4C	2-hole	—		41.6±0.175 (1.64±0.0069)		—	—
800H-3HZ4C	3-hole	—		—		43.2 +0.32/-0.18 (1.7 +0.0126/-0.0071)	—
800H-4HZ4C	4-hole	—		—		—	54.8±0.216 (2.16±0.0085)

## Additional Resources

These documents contain additional information concerning related products from Rockwell Automation. You can view or download publications at [rok.auto/literature](http://rok.auto/literature).

Resource	Description
800T/H 30 mm Push Buttons Brochure, publication <a href="#">800T-BR012</a>	Provides information regarding the design and selection of 800T/H push buttons.
EtherNet/IP Network Devices User Manual, <a href="#">ENET-UM006</a>	Describes how to configure and use EtherNet/IP devices to communicate on the EtherNet/IP network.
Ethernet Reference Manual, <a href="#">ENET-RM002</a>	Describes basic Ethernet concepts, infrastructure components, and infrastructure features.
System Security Design Guidelines Reference Manual, <a href="#">SECURE-RM001</a>	Provides guidance on how to conduct security assessments, implement Rockwell Automation products in a secure system, harden the control system, manage user access, and dispose of equipment.
American Standards, Configurations, and Ratings: Introduction to Motor Circuit Design, publication <a href="#">IC-AT001</a>	Provides an overview of American motor circuit design based on methods that are outlined in the NEC.
Industrial Components Preventive Maintenance, Enclosures, and Contact Ratings Specifications, publication <a href="#">IC-TD002</a>	Provides a quick reference tool for Allen-Bradley industrial automation controls and assemblies.
Safety Guidelines for the Application, Installation, and Maintenance of Solid-state Control, publication <a href="#">SGI-1.1</a>	Designed to harmonize with NEMA Standards Publication No. ICS 1.1-1987 and provides general guidelines for the application, installation, and maintenance of solid-state control in the form of individual devices or packaged assemblies incorporating solid-state components.
Industrial Automation Wiring and Grounding Guidelines, publication <a href="#">1770-4.1</a>	Provides general guidelines for installing a Rockwell Automation industrial system.
Product Certifications website, <a href="http://rok.auto/certifications">rok.auto/certifications</a> .	Provides declarations of conformity, certificates, and other certification details.

# Rockwell Automation Support

Use these resources to access support information.

<b>Technical Support Center</b>	Find help with how-to videos, FAQs, chat, user forums, Knowledgebase, and product notification updates.	<a href="http://rok.auto/support">rok.auto/support</a>
<b>Local Technical Support Phone Numbers</b>	Locate the telephone number for your country.	<a href="http://rok.auto/phonesupport">rok.auto/phonesupport</a>
<b>Technical Documentation Center</b>	Quickly access and download technical specifications, installation instructions, and user manuals.	<a href="http://rok.auto/techdocs">rok.auto/techdocs</a>
<b>Literature Library</b>	Find installation instructions, manuals, brochures, and technical data publications.	<a href="http://rok.auto/literature">rok.auto/literature</a>
<b>Product Compatibility and Download Center (PCDC)</b>	Download firmware, associated files (such as AOP, EDS, and DTM), and access product release notes.	<a href="http://rok.auto/pcdc">rok.auto/pcdc</a>

## Documentation Feedback

Your comments help us serve your documentation needs better. If you have any suggestions on how to improve our content, complete the form at [rok.auto/docfeedback](http://rok.auto/docfeedback).





Allen-Bradley, expanding human possibility, PentUFF, and Rockwell Automation are trademarks of Rockwell Automation, Inc.

EtherNet/IP is a trademark of ODVA, Inc.

Trademarks not belonging to Rockwell Automation are property of their respective companies.

Rockwell Automation maintains current product environmental compliance information on its website at [rok.auto/pec](http://rok.auto/pec).

Rockwell Otomasyon Ticaret A.Ş. Kar Plaza İş Merkezi E Blok Kat:6 34752, İçerenköy, İstanbul, Tel: +90 (216) 5698400 EEE Yönetmeliğine Uygundur

Connect with us.    

**rockwellautomation.com** ————— expanding **human possibility**<sup>®</sup>

AMERICAS: Rockwell Automation, 1201 South Second Street, Milwaukee, WI 53204-2496 USA, Tel: (1) 414.382.2000, Fax: (1) 414.382.4444

EUROPE/MIDDLE EAST/AFRICA: Rockwell Automation NV, Pegasus Park, De Kleetlaan 12a, 1831 Diegem, Belgium, Tel: (32) 2 663 0600, Fax: (32) 2 663 0640

ASIA PACIFIC: Rockwell Automation, Level 14, Core F, Cyberport 3, 100 Cyberport Road, Hong Kong, Tel: (852) 2887 4788, Fax: (852) 2508 1846

UNITED KINGDOM: Rockwell Automation Ltd. Pitfield, Kiln Farm Milton Keynes, MK11 3DR, United Kingdom, Tel: (44)(1908) 838-800, Fax: (44)(1908) 261-917

Publication 800-TD009J-EN-P - September 2022

Supersedes Publication 800-TD009I-EN-P - August 2022

Copyright © 2022 Rockwell Automation, Inc. All rights reserved. Printed in the U.S.A.