

# VisiSight M20A General Purpose Photoelectric Sensors

Catalog Numbers 42JA-B2LNA1-xx, 42JA-B2LNA2-xx, 42JA-B2LPA1-xx, 42JA-B2LPA2-xx, 42JA-C2LNA1-xx, 42JA-C2LPA1-xx, 42JA-D2LNA1-xx, 42JA-D2LPA1-xx, 42JA-E1EZB1-xx, 42JA-E2EZB1-xx, 42JA-N2LNA2-xx, 42JA-N2LPA2-xx, 42JA-P2LNA1-xx, 42JA-P2LPA1-xx, 42JA-R1LNA1-xx, 42JA-R1LPA1-xx, 42JA-R2LNA1-xx, 42JA-R2LPA1-xx, 42JA-W2LPA1-xx

Topic	Page
Description	1
Features	1
Available Models	1
Product Selection	2
Specifications	3
Status Indicators and User Interface	3
Wiring	3
Approximate Dimensions	4
Typical Response Curves	4
Additional Resources	5

## Features

- Visible light source offered on all models for ease of alignment
- Selectable light operate or dark operate adjustment knob
- Wide range of sensing modes
- 360° visible status indicators
- Additional transmitted beam models available with Infrared light source for excellent cross talk immunity
- Input to disable light source on transmitted beam emitter
- IP67 rated enclosure

## Summary of Changes

This publication contains the following new or updated information. This list includes substantive updates only and is not intended to reflect all changes.

Topic	Page
Added Clear Object Teach Process section.	3
Added UKCA certification.	3

## Available Models

- Diffuse
- Wide angle diffuse
- Background suppression
- Background reflection
- Polarized retroreflective
- Clear object detection
- Transmitted beam

## Description

42JA VisiSight™ M20A photoelectric sensors offer a wide range of sensing modes and an adjustable knob that simplifies sensitivity adjustment and offers light versus dark operate output selection.

The VisiSight offers a small rectangular package with visible light beam for ease of alignment and industry-standard mounting hole spacing of 25.4 mm (1 in.).

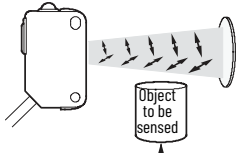
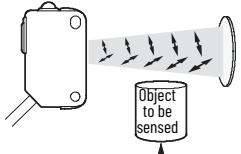
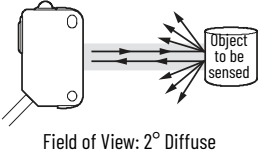
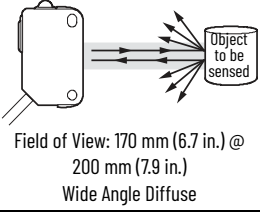
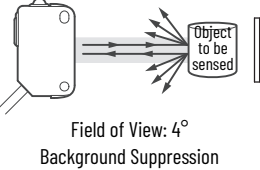
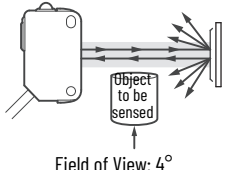
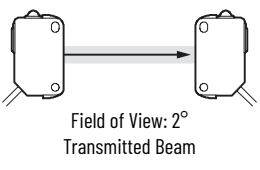

# Product Selection

Sensing Mode	Light Source	Sensing Distance	Sensitivity Adjustment	Output Function	Output Type	Cat. No. <sup>(1)</sup>
 <p>Field of View: 4° Polarized Retroreflective</p>	Visible red (634 nm)	0.01...5 m (0.3...16.4 ft) with 92-125 reflector	Adjustable knob	Selectable light or dark operate	NPN	42JA-P2LNA1-F4
					PNP	42JA-P2LPA1-F4
 <p>Field of View: 4° Clear Object Detection</p>	Visible red (634 nm)	0.01...2.5 m (0.3...8.2 ft) with 92-125 reflector	Adjustable knob	Selectable light or dark operate	NPN	42JA-C2LNA1-F4
					PNP	42JA-C2LPA1-F4
 <p>Field of View: 2° Diffuse</p>	Visible red (634 nm)	3...1000 mm (0.1...39.4 in.)	Adjustable knob	Selectable light or dark operate	NPN	42JA-D2LNA1-F4
					PNP	42JA-D2LPA1-F4
 <p>Field of View: 170 mm (6.7 in.) @ 200 mm (7.9 in.) Wide Angle Diffuse</p>	Visible red (634 nm)	0...200 mm (0...7.9 in.)	Adjustable knob	Selectable light or dark operate	PNP	42JA-W2LPA1-F4
 <p>Field of View: 4° Background Suppression</p>	Visible red (634 nm)	3...100 mm (0.1...3.9 in.)	Adjustable knob	Selectable light or dark operate	NPN	42JA-B2LNA1-F4
		3...350 mm (0.1...13.8 in.)			PNP	42JA-B2LPA1-F4
					NPN	42JA-B2LNA2-F4
					PNP	42JA-B2LPA2-F4
 <p>Field of View: 4° Background Reflection</p>	Visible red (634 nm)	3...350 mm (0.1...13.8 in.)	Adjustable knob	Selectable light or dark operate	NPN	42JA-N2LNA2-F4
					PNP	42JA-N2LPA2-F4
 <p>Field of View: 2° Transmitted Beam</p>	Visible red (634 nm)	10 m (32.8 ft)	No adjustment knob	Selectable light or dark operate	—	42JA-E2EZB1-F4
			Adjustable knob		NPN	42JA-R2LNA1-F4
			Adjustable knob		PNP	42JA-R2LPA1-F4
	Infrared (860 nm)	15 m (49.2 ft)	No adjustment knob		—	42JA-E1EZB1-F4
			Adjustable knob		NPN	42JA-R1LNA1-F4
			Adjustable knob		PNP	42JA-R1LPA1-F4

**(1) Connection options**

The following suffixes describe the available connection options:

- F4: Describes a 4-pin DC micro (M12) quick-disconnect on a 300 mm (11.8 in.) pigtail
- P4: Describes a 4-pin Pico (M8) integral quick-disconnect
- Y4: Describes a 4-pin Pico (M8) quick-disconnect on a 300 mm (11.8 in.) length pigtail
- A2: Describes a 2 m (6.6 ft) PVC cable

Additional connection options may be available. See [configurator.rockwellautomation.com](http://configurator.rockwellautomation.com) for available options by sensing mode.

# Specifications

Attribute	Value
Certifications	CE Marked for all applicable directives, UKCA Marked for all applicable regulations, and cULus Listed
EMC Directive	EN 60947-5-2
Standards	UL 60947-5-2
Ambient light immunity	EN 60697-5-2:2007+A:2012
<b>Functional Safety Parameters</b>	
MTTFd	860 a
Mission Time (TM)	20 a
Diagnostic Coverage (DC)	0%
<b>User Interface</b>	
Status indicators	Green and orange
Adjustments	Two adjustable knobs
<b>Optical</b>	
Light-emitting diode (LED)	Red and infrared (specific transmitted beam models)
<b>Electrical</b>	
Operating voltage	10 ...30V DC
Current consumption	<20 mA
Sensor protection	Reverse polarity and short circuit
Load current	100 mA max, resistive load
<b>Output</b>	
Output types	1 x PNP or 1 x NPN by catalog number
<b>Response Time</b>	
Diffuse	0.5 ms
Wide angle diffuse	0.5 ms
Background suppression	1 ms
Background reflection	1 ms
Polarized retroreflective	0.5 ms
Transmitted beam	2 ms
Clear object detection	0.5 ms
<b>Mechanical</b>	
Housing material	PC (Polycarbonate)
Lens material	PMMA
<b>Environmental</b>	
Enclosure rating	IP67
Operating temperature	-30...+60 °C (-22...+140 °F)

## Status Indicators and User Interface

Diffuse, Polarized Retroreflective, Background Suppression, Background Reflection, Transmitted Beam, and Wide Angle Diffuse

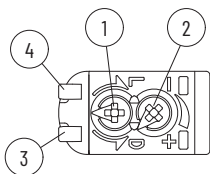

Item	Description
1	Light or dark operate selection
2	Sensing range adjustment knob
3	Orange status indicator
4	Green status indicator

### Clear Object Detection

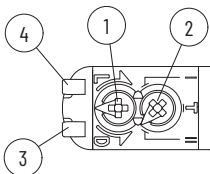

Item	Description
1	Light or dark operate selection
2	Teach knob
3	Orange status indicator
4	Green status indicator

Table 1 provides indicator status in the RUN mode, during operation for diffuse, polarized retroreflective, background suppression, background reflection, transmitted beam, and wide angle diffuse models.

**Table 1 - Operating Mode Indication**

Status Indicator Color	Status	Description
Green	OFF	Power is OFF
	ON	Power is ON
Orange	OFF	Output de-energized
	ON	Output energized

For clear object detection mode, the adjustment knob has three settings:

- Teach mode
- 18% contrast mode
- 40% contrast mode

## Clear Object Teach Process

To teach clear object detection:

1. Place the reflector at the desired distance away from the sensor.

**IMPORTANT** The sensor and the reflector must remain stationary and cannot change position during the teach-in process, otherwise the sensor must be reprogrammed.

2. To start the teach process, turn the potentiometer to the I position. The green and orange status indicators start to flash.
3. Turn the potentiometer to either the I or II position depending on what object you are trying to sense.
  - Position I must see an 18% change and works for most clear applications.
  - Position II must see a 40% change in the returned light from the reflector.

During the teach process, no objects can block the light path between sensor and reflector. The sensor is programming itself to the reflector to determine how much light is returned. That becomes 100% and from there you can choose either an 18% or 40% change to make the output switch.

## Wiring

The quick disconnect connector is shown in Figure 1. The pin numbers correspond to the plugs on the sensor.

**Figure 1 - Pinouts**

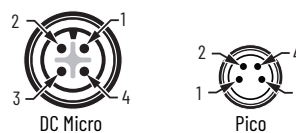

## Wiring Diagrams

Figure 2 - PNP Output Wiring

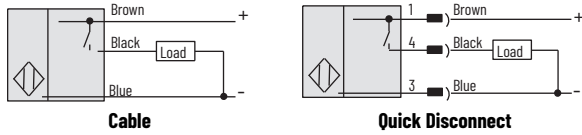

Figure 3 - NPN Output Wiring

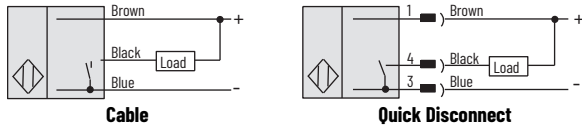
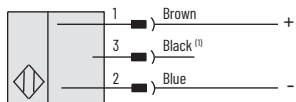

Figure 4 - Transmitted Beam Emitter



(1) The emitter light source is disabled when this pin is connected to 0V.

## Approximate Dimensions

Figure 5 - Integral M8 Pico QD Models

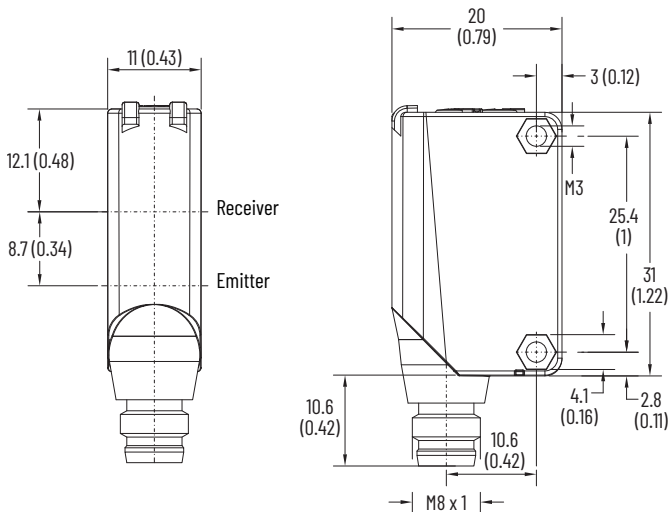
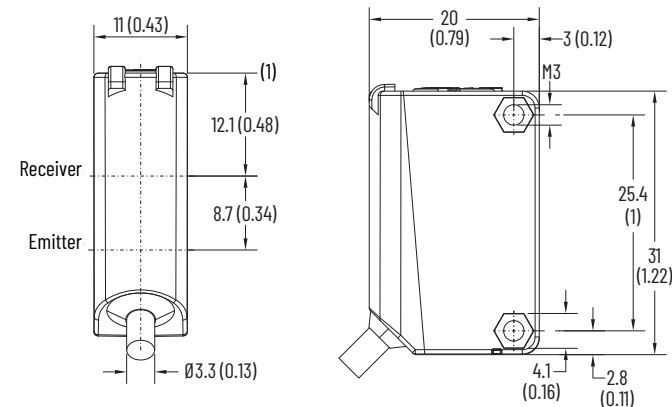

Figure 6 - 2 m (6.6 ft) Cable, 4-pin M12 QD on 300 mm (11.8 in.) Pigtail, 4-pin M8 QD on 300 mm (11.8 in.) Pigtail Models



(1) For the transmitted beam emitter, the LED centerline is located 14.1 mm (0.56 in.) lower than this point.

## Typical Response Curves

Figure 7 - Background Suppression - Beam Pattern

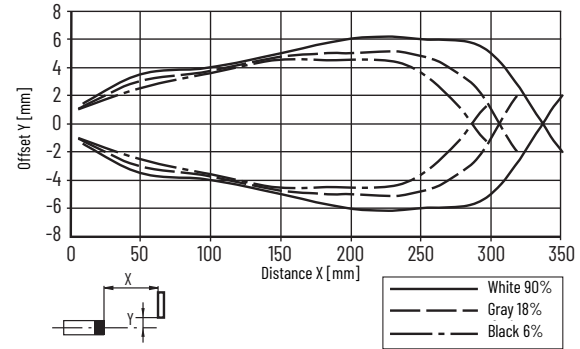

Figure 8 - Background Suppression - Detection Distance

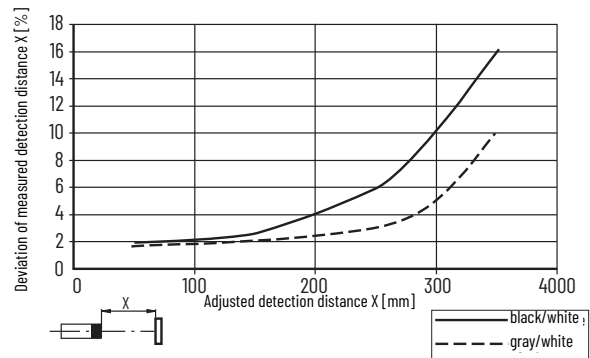

Figure 9 - Background Reflection - Minimum Object Height

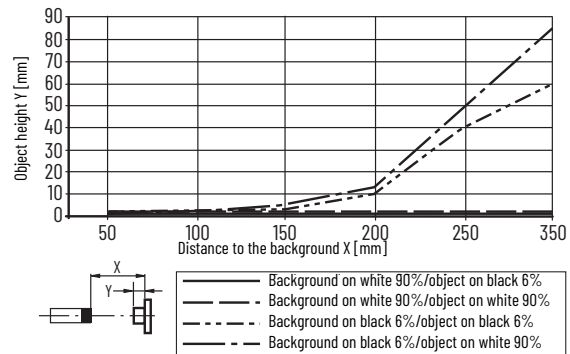
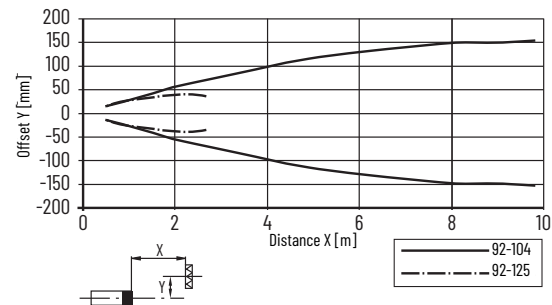
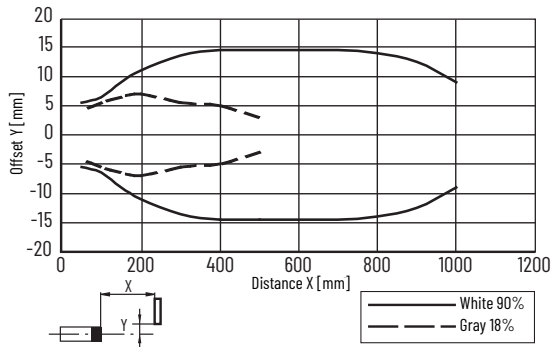

Figure 10 - Polarized Retroreflective - Beam Pattern



**Figure 11 - Diffuse - Beam Pattern**



**Figure 12 - Diffuse - Margin Curve**

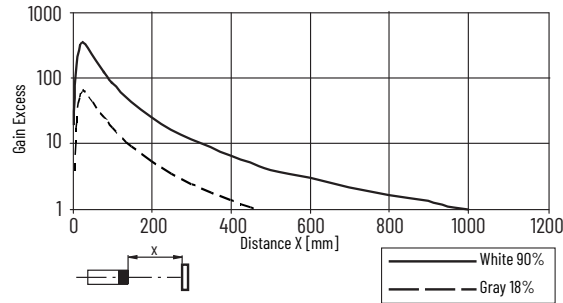

**Figure 13 - Diffuse - Detection Ranges**

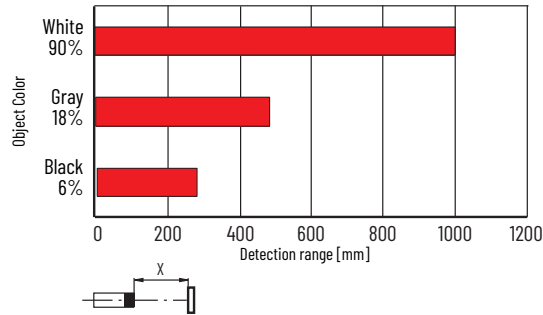

**Figure 14 - Clear Object Detection - Beam Pattern**

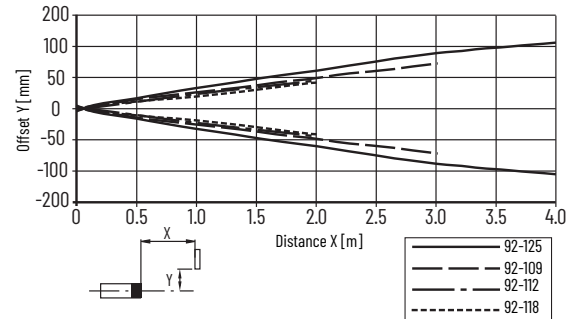

**Figure 15 - Transmitted Beam - Beam Pattern**

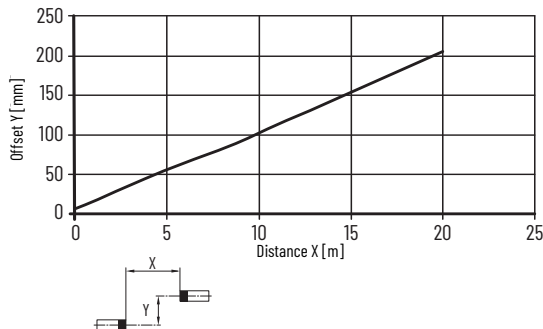

**Figure 16 - Transmitted Beam - Margin Curve**

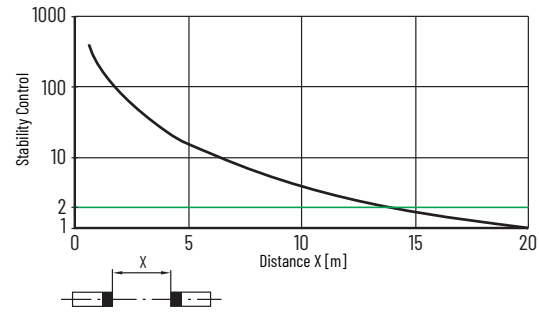

**Figure 17 - Wide Angle Diffuse - Margin Curve**

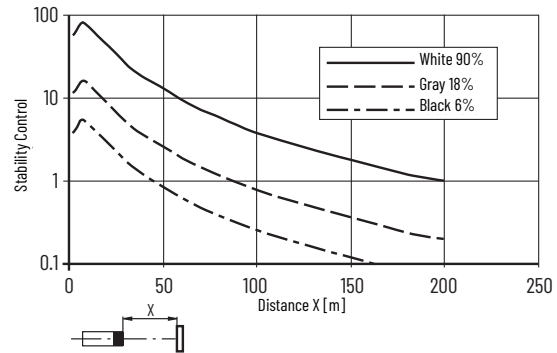

**Figure 18 - Wide Angle Diffuse - Beam Pattern**

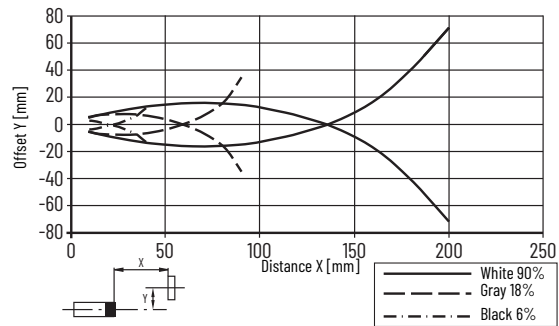

**Figure 19 - Wide Angle Diffuse - Detection Ranges**

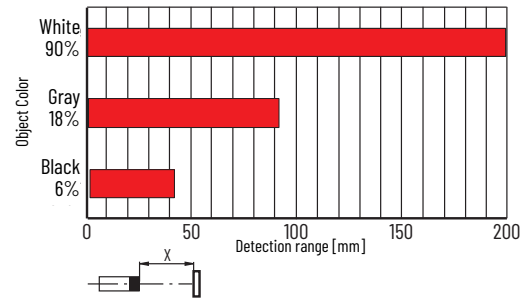

## Additional Resources

To download publications, visit [rok.auto/literature](http://rok.auto/literature) and search for the following publication numbers.

Resource	Description
VisiSight M20A Installation Instructions, publication <a href="#">42JA-IN001</a>	Provides information to install and wire a VisiSight M20A sensor.
Industrial Automation Wiring and Grounding Guidelines, publication <a href="#">1770-4.1</a>	Provides general guidelines for installing a Rockwell Automation industrial system.
Product Certifications website, <a href="http://rok.auto/certifications">rok.auto/certifications</a> .	Provides declarations of conformity, certificates, and other certification details.

# Rockwell Automation Support

Use these resources to access support information.

<b>Technical Support Center</b>	Find help with how-to videos, FAQs, chat, user forums, and product notification updates.	<a href="http://rok.auto/support">rok.auto/support</a>
<b>Knowledgebase</b>	Access Knowledgebase articles.	<a href="http://rok.auto/knowledgebase">rok.auto/knowledgebase</a>
<b>Local Technical Support Phone Numbers</b>	Locate the telephone number for your country.	<a href="http://rok.auto/phonesupport">rok.auto/phonesupport</a>
<b>Literature Library</b>	Find installation instructions, manuals, brochures, and technical data publications.	<a href="http://rok.auto/literature">rok.auto/literature</a>
<b>Product Compatibility and Download Center (PCDC)</b>	Download firmware, associated files (such as AOP, EDS, and DTM), and access product release notes.	<a href="http://rok.auto/pcdc">rok.auto/pcdc</a>





## Documentation Feedback

Your comments help us serve your documentation needs better. If you have any suggestions on how to improve our content, complete the form at [rok.auto/docfeedback](http://rok.auto/docfeedback).

Allen-Bradley, expanding human possibility, Rockwell Automation, and VisiSight are trademarks of Rockwell Automation, Inc. Trademarks not belonging to Rockwell Automation are property of their respective companies.

Rockwell Automation maintains current product environmental compliance information on its website at [rok.auto/pec](http://rok.auto/pec).

Rockwell Otomasyon Ticaret A.Ş. Kar Plaza İş Merkezi E Blok Kat:6 34752, İçerenköy, İstanbul, Tel: +90 (216) 5698400 EEE Yönetmeliğine Uygundur

Connect with us.    

**rockwellautomation.com** ————— expanding **human possibility**<sup>®</sup>

AMERICAS: Rockwell Automation, 1201 South Second Street, Milwaukee, WI 53204-2496 USA, Tel: (1) 414.382.2000, Fax: (1) 414.382.4444

EUROPE/MIDDLE EAST/AFRICA: Rockwell Automation NV, Pegasus Park, De Kleetlaan 12a, 1831 Diegem, Belgium, Tel: (32) 2 663 0600, Fax: (32) 2 663 0640

ASIA PACIFIC: Rockwell Automation, Level 14, Core F, Cyberport 3, 100 Cyberport Road, Hong Kong, Tel: (852) 2887 4788, Fax: (852) 2508 1846