



# PowerFlex 527 Adjustable Frequency AC Drive

Bulletin Number 25C



**Allen-Bradley**

by ROCKWELL AUTOMATION

User Manual

Original Instructions

## Important User Information

Read this document and the documents listed in the additional resources section about installation, configuration, and operation of this equipment before you install, configure, operate, or maintain this product. Users are required to familiarize themselves with installation and wiring instructions in addition to requirements of all applicable codes, laws, and standards.

Activities including installation, adjustments, putting into service, use, assembly, disassembly, and maintenance are required to be carried out by suitably trained personnel in accordance with applicable code of practice.

If this equipment is used in a manner not specified by the manufacturer, the protection provided by the equipment may be impaired.

In no event will Rockwell Automation, Inc. be responsible or liable for indirect or consequential damages resulting from the use or application of this equipment.

The examples and diagrams in this manual are included solely for illustrative purposes. Because of the many variables and requirements associated with any particular installation, Rockwell Automation, Inc. cannot assume responsibility or liability for actual use based on the examples and diagrams.

No patent liability is assumed by Rockwell Automation, Inc. with respect to use of information, circuits, equipment, or software described in this manual.

Reproduction of the contents of this manual, in whole or in part, without written permission of Rockwell Automation, Inc., is prohibited.

Throughout this manual, when necessary, we use notes to make you aware of safety considerations.



**WARNING:** Identifies information about practices or circumstances that can cause an explosion in a hazardous environment, which may lead to personal injury or death, property damage, or economic loss.



**ATTENTION:** Identifies information about practices or circumstances that can lead to personal injury or death, property damage, or economic loss. Attentions help you identify a hazard, avoid a hazard, and recognize the consequence.

**IMPORTANT** Identifies information that is critical for successful application and understanding of the product.

These labels may also be on or inside the equipment to provide specific precautions.



**SHOCK HAZARD:** Labels may be on or inside the equipment, for example, a drive or motor, to alert people that dangerous voltage may be present.



**BURN HAZARD:** Labels may be on or inside the equipment, for example, a drive or motor, to alert people that surfaces may reach dangerous temperatures.



**ARC FLASH HAZARD:** Labels may be on or inside the equipment, for example, a motor control center, to alert people to potential Arc Flash. Arc Flash will cause severe injury or death. Wear proper Personal Protective Equipment (PPE). Follow ALL Regulatory requirements for safe work practices and for Personal Protective Equipment (PPE).

The following icon may appear in the text of this document.



Identifies information that is useful and can help to make a process easier to do or easier to understand.

## Preface

About This Publication .....	7
Download Firmware, AOP, EDS, and Other Files .....	7
Summary of Changes.....	7
Who Should Use this Manual.....	7
Additional Resources .....	8
Manual Conventions .....	8
Drive Frame Sizes.....	9
General Precautions .....	10
Catalog Number Explanation .....	11

## Chapter 1

### Installation/Wiring

Mounting Considerations .....	13
Minimum Mounting Clearances .....	14
Ambient Operating Temperatures.....	15
Current Derating Curves .....	15
Debris Protection.....	16
Storage .....	16
AC Supply Source Considerations .....	17
Ungrounded Distribution Systems .....	17
Input Power Conditioning.....	18
General Grounding Requirements.....	18
Ground Fault Monitoring .....	18
Safety Ground - (PE) .....	19
Motor Ground.....	19
Shield Termination - SHLD.....	19
RFI Filter Grounding.....	19
Fuses and Circuit Breakers.....	20
Fusing .....	20
Circuit Breakers .....	20
Fuses and Circuit Breakers for PowerFlex 527 .....	21
Power and Control Module.....	26
Control Module Cover .....	29
Power Module Terminal Guard.....	29
Power Wiring.....	30
Motor Cable Types Acceptable for 100...600 Volt Installations ....	30
Reflected Wave Protection.....	32
Output Disconnect .....	32
Power Terminal Block .....	33
I/O Wiring .....	33
Motor Start/Stop Precautions.....	33
Signal and Control Wire Types.....	34
Maximum Control Wire Recommendations.....	34
Control I/O Terminal Block .....	34
PowerFlex 527 Control I/O Removable Terminal Block .....	35
CE Conformity .....	37

Low Voltage Directive (2014/35/EU)..... 37  
 EMC Directive (2014/30/EU) ..... 37  
 Machinery Directive (2006/42/EC) ..... 37  
 ATEX Directive (2014/34/EU) ..... 38  
 UKCA Conformity..... 38  
     Electrical Equipment (Safety) Regulations (2016 No. 1101) ..... 38  
     Electromagnetic Compatibility Regulations (2016 No. 1091)..... 38  
     Supply of Machinery (Safety) Regulations (2008 No. 1597) ..... 38  
     Equipment and Protective Systems Intended for Use in Potentially  
     Explosive Atmospheres Regulations (2016 No. 1107) ..... 38  
     General Considerations ..... 39

**Chapter 2**

**Start Up**

Prepare for Drive Startup ..... 45  
     Drive Startup Task List..... 45  
     Start, Stop, Direction, and Speed Control ..... 46  
 Understanding the PowerFlex 527 Display and Indicators..... 46  
     Startup Sequence..... 48  
     Device and Axis States ..... 48  
     Information Display ..... 49  
     Network Configuration ..... 49  
     Real-time Information Display..... 51  
 Drive Programming Tools ..... 51  
 Language Support ..... 52  
 Using the Ethernet Port ..... 52

**Chapter 3**

**Configuring the PowerFlex 527  
 Drive with Integrated Motion**

Configure the Drive ..... 53  
     Set the Network Configuration ..... 53  
 Configure the Logix Designer Application Project..... 54  
     Configure the Logix 5000 Controller ..... 54  
 Add a PowerFlex 527 Drive ..... 58  
 Configure the PowerFlex 527 Drive ..... 59  
     Configure Drive with Hardwired Safety Connections ..... 60  
     Configure Drive with Integrated Safety Connections ..... 61  
     Continue Drive Configuration ..... 64  
     Configure the Motion Group..... 67  
     Configure Axis Properties ..... 68  
     Download the Program ..... 79  
 Apply Power to the PowerFlex 527 Drive ..... 79  
 Test and Tune the Axes – Velocity and Position Control Modes ..... 80  
     Test the Axes ..... 80  
     Tune the Axes ..... 82



	<b>Chapter 4</b>	
<b>PowerFlex 527 Integrated Safe Torque-Off</b>	Certification.....	85
	Important Safety Considerations .....	85
	Category 3 Requirements According to ISO 13849 .....	85
	Stop Category Definition .....	86
	Performance Level (PL) and Safety Integrity Level (SIL) .....	86
	Description of Operation .....	86
	Probability of Dangerous Failure Per Hour (PFH) .....	86
	PFH Data .....	86
	Safe Torque-Off (STO) Feature .....	87
	Safe Torque-Off Feature Bypass.....	87
	As-Shipped Safety Configuration .....	88
	Out-of-Box (OOB) Safety State .....	88
	Recognizing the Out-of-Box State .....	88
	Restoring the Drive to the Out-of-Box State .....	88
	Safe Torque-Off Status .....	90
	Axis Tags .....	90
	Explicit Messages .....	91
	Safety Supervisor State.....	91
	Propose TUNID Blocked.....	91
	Safe Torque-Off Mode .....	92
Safe Torque-Off Faults .....	92	
	<b>Chapter 5</b>	
<b>Hardwired Control of Safe Torque-Off</b>	Description of Operation .....	93
	Selection of Hardwired Safe Torque-Off .....	93
	Operation of Hardwired Safe Torque-Off .....	93
	Troubleshoot the Safe Torque-Off Function .....	94
	Safe Torque-Off Connector Data .....	96
	Wire the Safe Torque-Off Circuit .....	96
	Safe Torque-Off Wiring Requirements .....	96
Safe Torque-Off Specifications .....	97	
	<b>Chapter 6</b>	
<b>Network Control of Safe Torque-Off</b>	Compatible Safety Controllers .....	99
	Selection of Network Safe Torque-Off .....	99
	Safety Application Requirements.....	100
	Network Safe Torque-off Specifications .....	100
	Safe Torque-off Assembly Tags.....	100
	STO Fault Reset .....	101
	Troubleshoot Network Safe Torque-Off.....	102
	Understanding Integrated Safety Drive Replacement.....	103
	Replacing an Integrated Safety Drive in a GuardLogix System.....	103
	Replacement with “Configure Only When No Safety Signature Exists” Enabled.....	104
Replacement with “Configure Always” Enabled.....	108	
Motion Direct Commands in Motion Control Systems.....	109	

Understanding STO Bypass When Using Motion Direct Commands  
110  
Logix Designer Application Warning Messages..... 110  
Torque Permitted in a Multi-workstation Environment ..... 112  
Warning Icon and Text in Axis Properties..... 112  
Functional Safety Considerations..... 114

**Chapter 7**

**Troubleshooting**

Safety Precautions ..... 115  
Interpret Status Indicators..... 115  
    Display Interface ..... 115  
    Fault Codes ..... 116  
    PowerFlex 527 Drive Status Indicators ..... 120  
General Troubleshooting ..... 122  
Logix 5000 Controller and Drive Behavior ..... 123  
    PowerFlex 527 Drive Exception Behavior..... 124

**Appendix A**

**Supplemental Drive Information**

Certifications..... 127  
Environmental Specifications ..... 128  
Technical Specifications ..... 129  
Power Specifications ..... 132

**Appendix B**

**Accessories and Dimensions**

Product Selection ..... 137  
Product Dimensions ..... 144  
    Replacing the PowerFlex 527 Control Module Internal Fan..... 157

**Appendix C**

**Out-of-Box Configuration**

Recommended Out-of-Box Settings ..... 159  
Setting the ACO/AVO Attribute..... 162

**Appendix D**

**Encoder Option Card Usage**

Installing the Encoder Option Card..... 163  
Removing the Encoder Option Card ..... 164  
Encoder Option Card Usage..... 164  
    Encoder Interface ..... 165  
    HTL/TTL DIP Switches..... 166  
Wiring Notes ..... 166

**Index**

..... 167

## About This Publication

The purpose of this manual is to provide you with the basic information that is needed to install, startup, and troubleshoot the PowerFlex® 527 Adjustable Frequency AC Drive.

Topic	Page
Who Should Use this Manual	7
Additional Resources	8
Manual Conventions	8
Drive Frame Sizes	9
General Precautions	10
Catalog Number Explanation	11

Rockwell Automation recognizes that some of the terms that are currently used in our industry and in this publication are not in alignment with the movement toward inclusive language in technology. We are proactively collaborating with industry peers to find alternatives to such terms and making changes to our products and content. Please excuse the use of such terms in our content while we implement these changes.

## Download Firmware, AOP, EDS, and Other Files

Download firmware, associated files (such as AOP, EDS, and DTM), and access product release notes from the Product Compatibility and Download Center at [rok.auto/pcdc](http://rok.auto/pcdc).

## Summary of Changes

This publication contains the following new or updated information. This list includes substantive updates only and is not intended to reflect all changes.

Topic	Page
Updated template	Throughout
Added Inclusive Language acknowledgment	7
Added topic UKCA Conformity	13, 38
Added footnotes to table Altitude Limit (Based on Voltage)	16
Updated section Fuses and Circuit Breakers	20
Updated Fuse and Circuit Breaker tables for 140M/140MT and UL 61800-5-1 applications	21...25
Updated section General Considerations for UK LV Regulations	39, 40
Updated table PFD and PFH Data	87
Updated Certifications	127, 128
Updated table Dynamic Brake Resistors	138
Updated table EMC Line Filters in Appendix B	139

## Who Should Use this Manual

This manual is intended for qualified personnel. You must be able to program and operate Adjustable Frequency AC Drive devices. In addition, you must have a working knowledge and understanding of ControlLogix®/Studio 5000® and CIP Motion™.

If you do not have a basic understanding of the PowerFlex 527 drives, contact your local Rockwell Automation sales representative for information on available training courses.

## Additional Resources

All recommended documentation that is listed in this section is available online at [rok.auto/literature](http://rok.auto/literature).

The following publications provide general information:

Title	Publication
Wiring and Grounding Guidelines for Pulse Width Modulated (PWM) AC Drives	<a href="#">DRIVES-IN001</a>
Preventive Maintenance of Industrial Control and Drive System Equipment	<a href="#">DRIVES-TD001</a>
Safety Guidelines for the Application, Installation, and Maintenance of Solid-State Control	<a href="#">SGI-1.1</a>
Guarding Against Electrostatic Damage	<a href="#">8000-4.5.2</a>
Industrial Automation Wiring and Grounding Guidelines	<a href="#">1770-4.1</a>
Product Certifications website, <a href="http://rok.auto/certifications">rok.auto/certifications</a>	

The following publications provide information on the use and configuration of GuardLogix® 5570, CompactLogix™ 5370, ControlLogix 5580, GuardLogix 5580, and Compact GuardLogix 5370.

Title	Publication
GuardLogix 5570 Controllers User Manual	<a href="#">1756-UM022</a>
GuardLogix 5570 and Compact GuardLogix 5370 Safety Reference Manual	<a href="#">1756-RM099</a>
CompactLogix 5370 Controllers User Manual	<a href="#">1769-UM021</a>
ControlLogix 5580 and GuardLogix 5580 Controllers User Manual	<a href="#">1756-UM543</a>
Compact GuardLogix 5370 Controllers User Manual	<a href="#">1769-UM022</a>
PowerFlex Dynamic Braking Resistor Calculator Application Technique	<a href="#">PFLEX-AT001</a>

The following publications provide information on the use and configuration of PowerFlex 527 drives on an EtherNet/IP network.

Title	Publication
Integrated Motion on the EtherNet/IP Network Configuration and Startup User Manual	<a href="#">MOTION-UM003</a>
Integrated Motion on the EtherNet/IP Network	<a href="#">MOTION-RM003</a>

## Manual Conventions

- In this manual we refer to PowerFlex 527 Adjustable Frequency AC Drive as: drive, PowerFlex 527, PowerFlex 527 drive, or PowerFlex 527 AC drive.
- Specific drives within the PowerFlex 520-series may be referred to as:
  - PowerFlex 523, PowerFlex 523 drive, or PowerFlex 523 AC drive.
  - PowerFlex 525, PowerFlex 525 drive, or PowerFlex 525 AC drive.
  - PowerFlex 527, PowerFlex 527 drive, or PowerFlex 527 AC drive.
- The following words are used throughout the manual to describe an action:

Words	Meaning
Can	Possible, able to do something
Cannot	Not possible, not able to do something
May	Permitted, allowed
Must	Unavoidable, you must do this
Shall	Required and necessary
Should	Recommended
Should Not	Not recommended



- The Studio 5000 Automation Engineering and Design Environment® (formerly RSLogix 5000®) combines engineering and design elements into one standard framework that enables optimized productivity and reduced time to commission. As part of the Studio 5000 environment, Studio 5000 Logix Designer® application is the tool that is used to program Logix programmable automation controllers for process, batch, discrete, drives, safety, and motion-based systems. The Studio 5000 environment is the foundation for system engineering design tools and capabilities — it is the one tool for engineers to design and develop all elements of their control system.

These conventions are used throughout this manual:

- Bulleted lists such as this one provide information, not procedural steps.
- Numbered lists provide steps or hierarchical information.

## Drive Frame Sizes

The PowerFlex 527 AC drive belongs to the new generation of PowerFlex 520-series drives, which also consist of PowerFlex 523 and PowerFlex 525 drives.

Similar PowerFlex 520-series drive sizes are grouped into frame sizes to simplify spare parts ordering, dimensioning, and so on. A cross-reference of drive catalog numbers and their respective frame sizes is provided in [Appendix B on page 137](#).

## General Precautions



**ATTENTION:** The drive contains high-voltage capacitors, which take time to discharge after removal of mains supply. Before working on drive, verify isolation of mains supply from line inputs [R, S, T (L1, L2, L3)]. Wait three minutes for capacitors to discharge to safe voltage levels (DC Bus voltage is less than 50V DC). Failure to do so may result in personal injury or death. Darkened display LEDs is not an indication that capacitors have discharged to safe voltage levels.

**ATTENTION:** Only qualified personnel familiar with adjustable frequency AC drives and associated machinery should plan or implement the installation, start-up and subsequent maintenance of the system. Failure to comply may result in personal injury and/or equipment damage.

**ATTENTION:** This drive contains ESD (Electrostatic Discharge) sensitive parts and assemblies. Static control precautions are required when installing, testing, servicing, or repairing this assembly. Component damage may result if ESD control procedures are not followed. If you are not familiar with static control procedures, reference publication [8000-4.5.2](#), "Guarding Against Electrostatic Damage" or any other applicable ESD protection handbook.

**ATTENTION:** An incorrectly applied or installed drive can result in component damage or a reduction in product life. Wiring or application errors, such as undersizing the motor, incorrect or inadequate AC supply, or excessive ambient temperatures may result in malfunction of the system.

**ATTENTION:** The bus regulator function is extremely useful for preventing nuisance overvoltage faults resulting from aggressive decelerations, overhauling loads, and eccentric loads. However, it can also cause either of the following two conditions to occur.

1. Fast positive changes in input voltage or imbalanced input voltages can cause uncommanded positive speed changes.
2. Actual deceleration times can be longer than commanded deceleration times.

However, a "Decel Override" fault is generated if the drive remains in this state for one minute. If this condition is unacceptable, the bus regulator must be disabled by setting the Bus Regulator Action in the Logix Designer application. In addition, installing a properly sized dynamic brake resistor provides equal or better performance in most cases. See [Dynamic Brake Resistors on page 138](#) to select an appropriate resistor for your drive rating.

**ATTENTION:** Risk of injury or equipment damage exists. Drive does not contain user-serviceable components. Do not disassemble drive chassis.

## Catalog Number Explanation

1-3	4	5	6-8	9	10	11	12	13	14
25C	-	B	2P3	N	1	1	4	-	-
Drive	Dash	Voltage Rating	Rating	Enclosure	Reserved	Emission Class	Reserved	Dash	Dash

Code	Type
25C	PowerFlex 527

Code	Voltage	Phase
V	120V AC	1
A	240V AC	1
B	240V AC	3
D	480V AC	3
E	600V AC	3

Code	Enclosure
N	IP20 NEMA / Open

Code	EMC Filter
0	No Filter
1	Filter

Code	Braking
4	Standard

Code	Interface Module
1	Standard

Output Current @ 1 Phase, 100...120V Input						
Code	Amps	Frame	ND		HD	
			HP	kW	HP	kW
2P5 <sup>(1)</sup>	2.5	A	0.5	0.4	0.5	0.4
4P8 <sup>(1)</sup>	4.8	B	1.0	0.75	1.0	0.75
6P0 <sup>(1)</sup>	6.0	B	1.5	1.1	1.5	1.1

Output Current @ 1 Phase, 200...240V Input						
Code	Amps	Frame	ND		HD	
			HP	kW	HP	kW
2P5 <sup>(1)</sup>	2.5	A	0.5	0.4	0.5	0.4
4P8 <sup>(1)</sup>	4.8	A	1.0	0.75	1.0	0.75
8P0 <sup>(1)</sup>	8.0	B	2.0	1.5	2.0	1.5
011 <sup>(1)</sup>	11.0	B	3.0	2.2	3.0	2.2

Output Current @ 3Phase, 200...240V Input						
Code	Amps	Frame	ND		HD	
			HP	kW	HP	kW
2P5 <sup>(1)</sup>	2.5	A	0.5	0.4	0.5	0.4
5P0 <sup>(1)</sup>	5.0	A	1.0	0.75	1.0	0.75
8P0 <sup>(1)</sup>	8.0	A	2.0	1.5	2.0	1.5
011 <sup>(1)</sup>	11.0	A	3.0	2.2	3.0	2.2
017 <sup>(1)</sup>	17.5	B	5.0	4.0	5.0	4.0
024 <sup>(1)</sup>	24.0	C	7.5	5.5	7.5	5.5
032 <sup>(1)</sup>	32.2	D	10.0	7.5	10.0	7.5
048 <sup>(2)</sup>	48.3	E	15.0	11.0	10.0	7.5

Output Current @ 3 Phase, 380...480V Input						
Code	Amps	Frame	ND		HD	
			HP	kW	HP	kW
1P4 <sup>(1)</sup>	1.4	A	0.5	0.4	0.5	0.4
2P3 <sup>(1)</sup>	2.3	A	1.0	0.75	1.0	0.75
4P0 <sup>(1)</sup>	4.0	A	2.0	1.5	2.0	1.5
6P0 <sup>(1)</sup>	6.0	A	3.0	2.2	3.0	2.2
010 <sup>(1)</sup>	10.5	B	5.0	4.0	5.0	4.0
013 <sup>(1)</sup>	13.0	C	7.5	5.5	7.5	5.5
017 <sup>(1)</sup>	17.0	C	10.0	7.5	10.0	7.5
024 <sup>(1)</sup>	24.0	D	15.0	11.0	15.0	11.0
030 <sup>(2)</sup>	30.0	D	20.0	15.0	15.0	11.0
037 <sup>(2)</sup>	37.0	E	25.0	18.5	20.0	15.0
043 <sup>(2)</sup>	43.0	E	30.0	22.0	25.0	18.5

Output Current @ 3 Phase, 525...600V Input						
Code	Amps	Frame	ND		HD	
			HP	kW	HP	kW
0P9 <sup>(1)</sup>	0.9	A	0.5	0.4	0.5	0.4
1P7 <sup>(1)</sup>	1.7	A	1.0	0.75	1.0	0.75
3P0 <sup>(1)</sup>	3.0	A	2.0	1.5	2.0	1.5
4P2 <sup>(1)</sup>	4.2	A	3.0	2.2	3.0	2.2
6P6 <sup>(1)</sup>	6.6	B	5.0	4.0	5.0	4.0
9P9 <sup>(1)</sup>	9.9	C	7.5	5.5	7.5	5.5
012 <sup>(1)</sup>	12.0	C	10.0	7.5	10.0	7.5
019 <sup>(1)</sup>	19.0	D	15.0	11.0	15.0	11.0
022 <sup>(2)</sup>	22.0	D	20.0	15.0	15.0	11.0

(1) 150% Overload capability for up to 60 s, 180% for up to 3 s.

(2)   110% Overload capability for up to 60 s, 150% for up to 3 s.

**Notes:**



## Installation/Wiring

This chapter provides information on mounting and wiring the PowerFlex 527 drives.

Topic	Page
Mounting Considerations	13
AC Supply Source Considerations	17
General Grounding Requirements	18
Fuses and Circuit Breakers	20
Power and Control Module	26
Control Module Cover	29
Power Module Terminal Guard	29
Power Wiring	30
Power Terminal Block	33
I/O Wiring	33
Control I/O Terminal Block	34
CE Conformity	37
UKCA Conformity	38

Most startup difficulties are the result of incorrect wiring. Every precaution must be taken to verify that the wiring is done as instructed. All items must be read and understood before the actual installation begins.



**ATTENTION:** The following information is merely a guide for proper installation. Rockwell Automation cannot assume responsibility for the compliance or the noncompliance to any code, national, local or otherwise for the proper installation of this drive or associated equipment. A hazard of personal injury and/or equipment damage exists if codes are ignored during installation.

### Mounting Considerations

- Mount the drive upright on a flat, vertical, and level surface.

Frame	Screw Size	Screw Torque
A	M5 (#10...24)	1.56...1.96 N•m (14...17 lb•in)
B	M5 (#10...24)	1.56...1.96 N•m (14...17 lb•in)
C	M5 (#10...24)	1.56...1.96 N•m (14...17 lb•in)
D	M5 (#10...24)	2.45...2.94 N•m (22...26 lb•in)
E	M8 (5/16 in)	6.0...7.4 N•m (53...65 lb•in)

- Protect the cooling fan by avoiding dust or metallic particles.
- Do not expose to a corrosive atmosphere.
- Protect from moisture and direct sunlight.

## Minimum Mounting Clearances

For mounting dimensions, see [Product Dimensions on page 144](#).

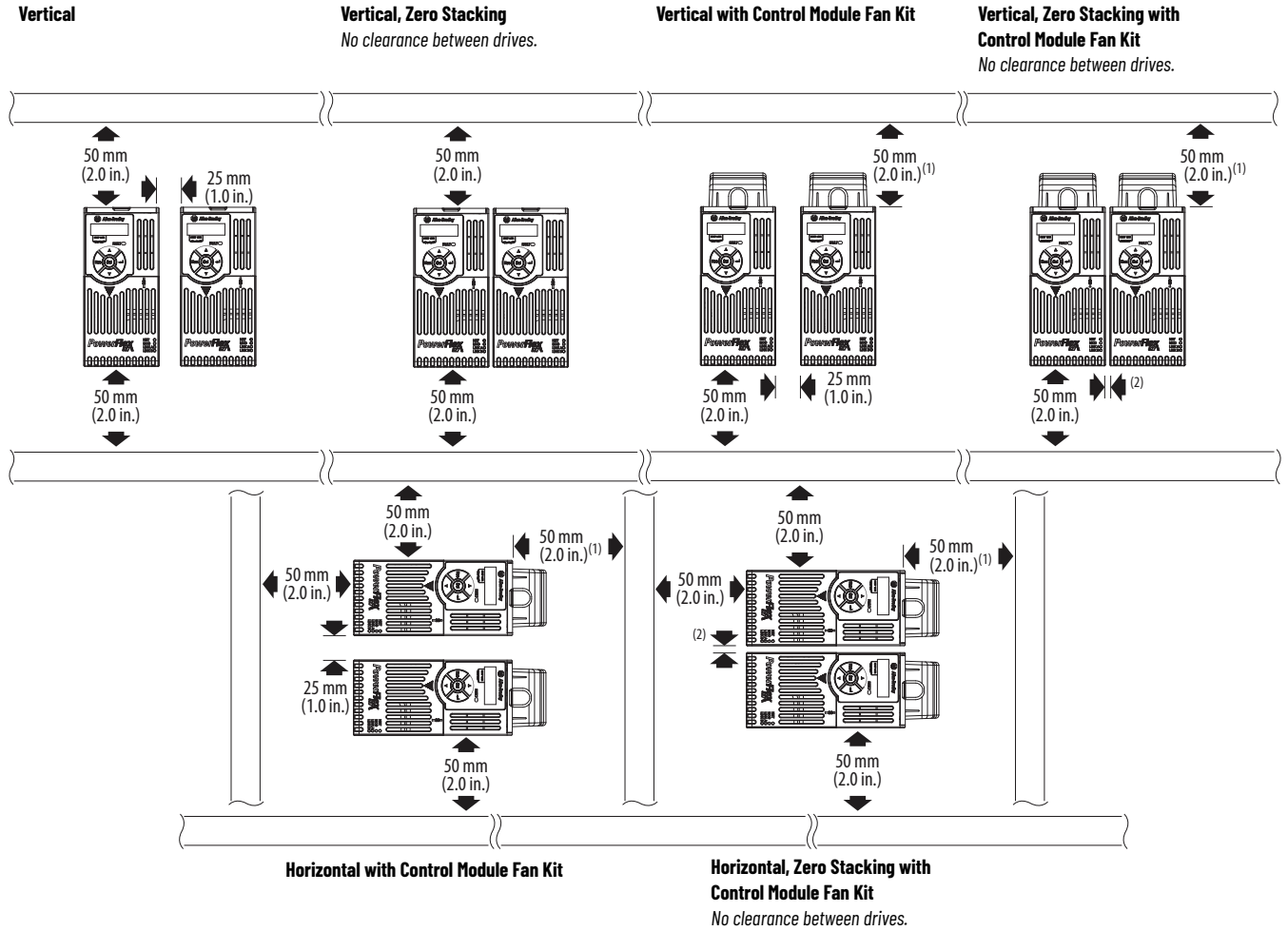

(1) For Frame E with Control Module Fan Kit only, clearance of 95 mm (3.7 in.) is required.  
 (2) For Frame E with Control Module Fan Kit only, clearance of 12 mm (0.5 in.) is required.

## Ambient Operating Temperatures

For optional accessories and kits, see [Accessories and Dimensions on page 137](#).

Mounting	Enclosure Rating <sup>(1)</sup>	Ambient Temperature			
		Minimum	Maximum (No Derate)	Maximum (Derate) <sup>(2)</sup>	Maximum with Control Module Fan Kit (Derate) <sup>(3)(5)</sup>
Vertical	IP 20/Open Type	-20 °C (-4 °F)	50 °C (122 °F)	—	70 °C (158 °F)
	IP 30/NEMA 1/UL Type 1		45 °C (113 °F)	55 °C (131 °F)	—
Vertical, Zero Stacking	IP 20/Open Type		45 °C (113 °F)	—	65 °C (149 °F)
Horizontal with Control Module Fan Kit <sup>(4)(5)</sup>	IP 20/Open Type		50 °C (122 °F)	—	70 °C (158 °F)
Horizontal, Zero Stacking with Control Module Fan Kit <sup>(4)(5)</sup>	IP 20/Open Type		45 °C (113 °F)	—	65 °C (149 °F)

(1) IP 30/NEMA 1/UL Type 1 rating requires installation of the PowerFlex 520-Series IP 30/NEMA 1/UL Type 1 option kit, catalog number 25-JBAx.

(2) For catalogs 25C-D1P4N104 and 25C-EOP9N104, the temperature that is listed under the Maximum (Derate) column is reduced by 5 °C (9 °F) for all mounting methods.

(3) For catalogs 25C-D1P4N104 and 25C-EOP9N104, the temperature that is listed under the Maximum with Control Module Fan Kit (Derate) column is reduced by 10 °C (18 °F) for vertical and vertical with zero stacking mounting methods only.

(4) Catalogs 25C-D1P4N104 and 25C-EOP9N104 cannot be mounted using either of the horizontal mounting methods.

(5) Requires installation of the PowerFlex 520-Series Control Module Fan Kit, catalog number 25-FANx-70C.

## Current Derating Curves

### Vertical Mounting

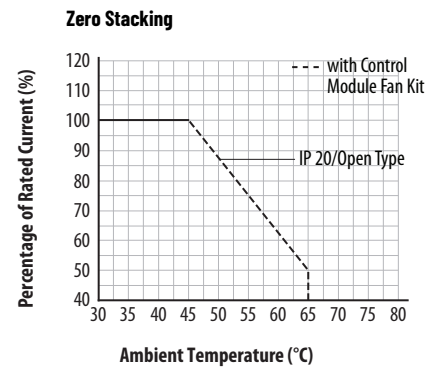
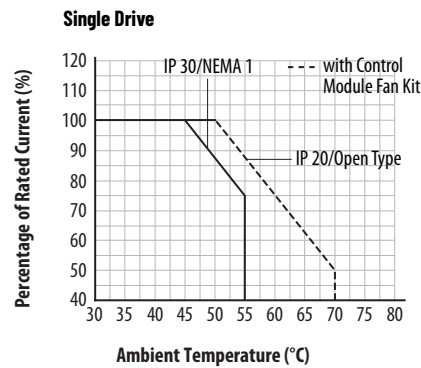

### Horizontal/Floor Mounting

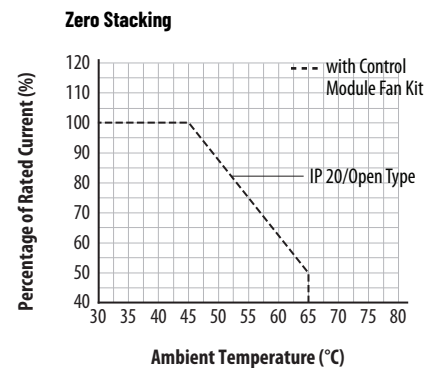
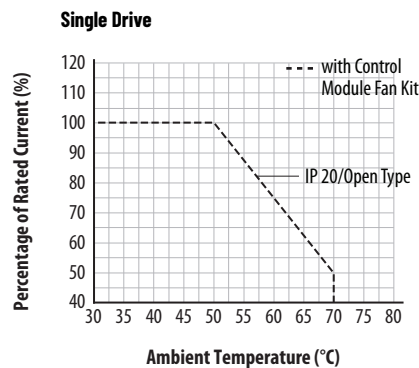

### Derating Guidelines for High Altitude

The drive can be used without derating at a maximum altitude of 1000 m (3300 ft). If the drive is used above 1000 m (3300 ft):

- Derate the maximum ambient temperature by 5 °C (9 °F) for every additional 1000 m (3300 ft), subject to limits listed in [Table 1](#).  
Or
- Derate the output current by 10% for every additional 1000 m (3300 ft), up to 3000 m (9900 ft), subject to limits listed in [Table 1](#).

**Table 1 - Altitude Limit (Based on Voltage)**

Drive Rating	Center Ground (Wye Neutral) (1)	Corner Ground, Impedance Ground, or Ungrounded (1)(2)
100...120V 1-Phase	6000 m	6000 m
200...240V 1-Phase	2000 m	2000 m
200...240V 3-Phase	6000 m	2000 m
380...480V 3-Phase	4000 m	2000 m
525...600V 3-Phase	2000 m	2000 m

(1) The circuit breaker that is used in the drive may have different altitude specifications. See publications [140UT-TD001](#) and [140-TD005](#) for more information.

(2) Impedance Ground and Ungrounded limits are not evaluated as part of UL specifications.

### High Altitude

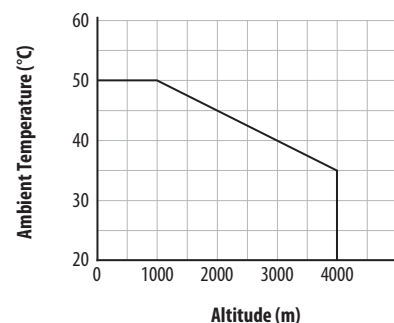
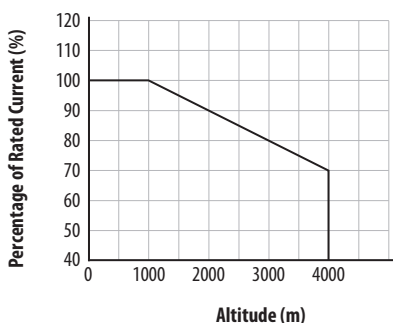

### Debris Protection

Take precautions to prevent debris from falling through the vents of the drive housing during installation.

### Storage

- Store within an ambient temperature range of -40...+85 °C (-140...+185 °F)<sup>(1)</sup>.
- Store within a relative humidity range of 0...95%, noncondensing.
- Do not expose to a corrosive atmosphere.

(1) The maximum ambient temperature for storing a Frame E drive is 70 °C (158 °F).



## AC Supply Source Considerations

### Ungrounded Distribution Systems



#### ATTENTION:

- PowerFlex 527 drives contain protective MOVs that are referenced to ground. These devices must be disconnected if the drive is installed on an ungrounded or resistive grounded distribution system.
- Removing MOVs in drives with an embedded filter will also disconnect the filter capacitor from earth ground.

#### Disconnecting MOVs

To help prevent drive damage, the MOVs connected to ground shall be disconnected if the drive is installed on an ungrounded distribution system (IT mains) where the line-to-ground voltages on any phase could exceed 125% of the nominal line-to-line voltage. To disconnect these devices, remove the jumper that is shown in the following diagrams.

1. Turn the screw counterclockwise to loosen.
2. Pull the jumper completely out of the drive chassis.
3. Tighten the screw to keep it in place.

#### Jumper Location (Typical)

Power module

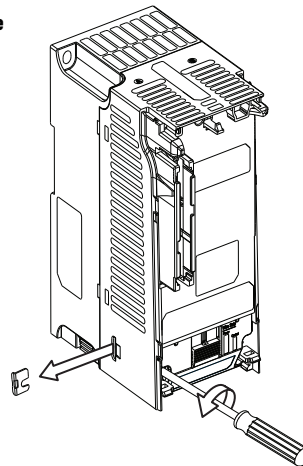

**IMPORTANT** Tighten screw after jumper removal.

#### Phase to Ground MOV Removal

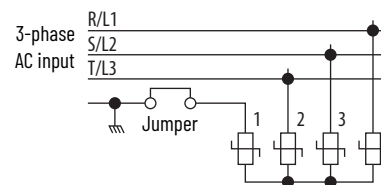

## Input Power Conditioning

The drive is suitable for direct connection to input power within the rated voltage of the drive (see [Technical Specifications on page 129](#)). Listed in [Table 2](#) are certain input power conditions which may cause component damage or reduction in product life. If any of these conditions exist, install one of the devices that are listed under the heading Corrective Action on the line side of the drive.

**IMPORTANT** Only one device per branch circuit is required. It should be mounted closest to the branch and sized to handle the total current of the branch circuit.

**Table 2 - Input Power Conditions**

Input Power Condition	Corrective Action
Low Line Impedance (less than 1% line reactance)	<ul style="list-style-type: none"> <li>• Install Line Reactor.<sup>(1)</sup></li> <li>or</li> <li>• Install Isolation Transformer.</li> </ul>
Greater than 120 kVA supply transformer	
Line has power factor correction capacitors	<ul style="list-style-type: none"> <li>• Install Line Reactor.<sup>(1)</sup></li> <li>or</li> <li>• Install Isolation Transformer.</li> </ul>
Line has frequent power interruptions	
Line has intermittent noise spikes in excess of 6000V (lightning)	<ul style="list-style-type: none"> <li>• Remove MOV jumper to ground.</li> <li>or</li> <li>• Install Isolation Transformer with grounded secondary if necessary.</li> </ul>
Phase to ground voltage exceeds 125% of normal line-to-line voltage	
Ungrounded distribution system	<ul style="list-style-type: none"> <li>• Install Line Reactor.<sup>(1)</sup></li> </ul>
240V open delta configuration (stinger leg) <sup>(2)</sup>	

(1) See [Accessories and Dimensions on page 137](#) for accessory ordering information.

(2) For drives applied on an open delta with a middle phase grounded neutral system, the phase opposite the phase that is tapped in the middle to the neutral or earth is referred to as the "stinger leg," "high leg," "red leg," and so on. This leg should be identified throughout the system with red or orange tape on the wire at each connection point. The stinger leg should be connected to the center Phase B on the reactor. See [Bulletin 1321-3R Series Line Reactors on page 143](#) for specific line reactor part numbers.

## General Grounding Requirements

The drive Safety Ground -  $\ominus$  (PE) must be connected to system ground. Ground impedance must conform to the requirements of national and local industrial safety regulations and/or electrical codes. The integrity of all ground connections should be periodically checked.

### Typical Grounding

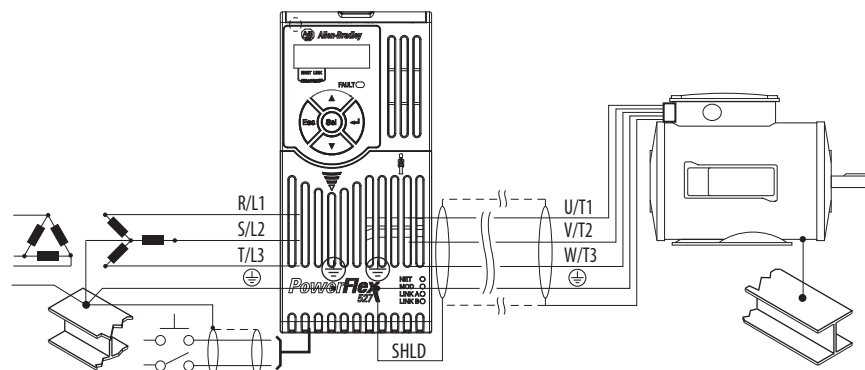

## Ground Fault Monitoring

If a system ground fault monitor (RCD) is to be used, only Type B (adjustable) devices should be used to avoid nuisance tripping.

## Safety Ground - $\oplus$ (PE)

This is the safety ground for the drive that is required by code. One of these points must be connected to adjacent building steel (girder, joist), a floor ground rod, or busbar. Grounding points must comply with national and local industrial safety regulations and/or electrical codes.

## Motor Ground

The motor ground must be connected to one of the ground terminals on the drive.

## Shield Termination - SHLD

Either of the safety ground terminals that are located on the power terminal block provides a grounding point for the motor cable shield. The **motor cable** shield connected to one of these terminals (drive end) should also be connected to the motor frame (motor end). Use a shield terminating or EMI clamp to connect the shield to the safety ground terminal. The earthing plate or conduit box option may be used with a cable clamp for a grounding point for the cable shield.

When shielded cable is used for **control and signal wiring**, the shield should be grounded at the source end only, not at the drive end.

## RFI Filter Grounding

Using a drive with filter may result in relatively high ground leakage currents. Therefore, the **filter must only be used in installations with grounded AC supply systems and be permanently installed and solidly grounded** (bonded) to the building power distribution ground. Verify that the incoming supply neutral is solidly connected (bonded) to the same building power distribution ground. Grounding must not rely on flexible cables and should exclude any form of plug or socket that would permit inadvertent disconnection. Some local codes may require redundant ground connections. The integrity of all connections should be periodically checked.

## Fuses and Circuit Breakers

The PowerFlex 527 drive does not provide branch short circuit protection. This product should be installed with either input fuses or an input circuit breaker. National and local industrial safety regulations and/or electrical codes may determine additional requirements for these installations.

The tables under [Fuses and Circuit Breakers for PowerFlex 527 on page 21](#) provide recommended AC line input fuse and circuit breaker information. See Fusing and Circuit Breakers below for UL and IEC requirements. Sizes that are listed are the recommended sizes based on 40 °C(104 °F) and the U.S. N.E.C. Other country, state, or local codes may require different ratings.

### Fusing

The recommended fuse types are listed in the tables under [Fuses and Circuit Breakers for PowerFlex 527 on page 21](#). If available current ratings do not match those listed in the tables provided, choose the next higher fuse rating.

- IEC – BS88 (British Standard) Parts 1 & 2<sup>(1)</sup>, EN60269-1, Parts 1 & 2, type GG or equivalent should be used.
- UL – UL Class CC, T, or J should be used.

### Circuit Breakers

The “non-fuse” listings in the tables under [Fuses and Circuit Breakers for PowerFlex 527 on page 21](#) include inverse time circuit breakers, instantaneous trip circuit breakers (motor circuit protectors), and 140M/140MT self-protected combination motor controllers. If one of these is chosen as the desired protection method, the following requirements apply:

- IEC – Both types of circuit breakers and 140M/140MT self-protected combination motor controllers are acceptable for IEC installations.
- UL – Only inverse time circuit breakers and the specified 140M/140MT self-protected combination motor controllers are acceptable for UL installations.

#### *Bulletin 140M/140MT (Self-Protected Combination Controller)/UL489 Circuit Breakers*

When using Bulletin 140M/140MT or UL489 rated circuit breakers, the following guidelines that are listed must be followed to meet the NEC requirements for branch circuit protection.

- Bulletin 140M/140MT can be used in single motor applications.
- Bulletin 140M/140MT can be used up stream from the drive **without** the need for fuses.

If the DC Bus terminals or the Dynamic Brake terminals are used, the drive must be installed in an enclosure and fuses must be used for input protection (for CE applications only). The ventilated enclosure needs to be IP 20 rating or higher and at least 1.5x size larger than the drive.

(1) Typical designations include, but may not be limited to the following; Parts 1 & 2: AC, AD, BC, BD, CD, DD, ED, EFS, EF, FF, FG, GF, GG, GH.



## Fuses and Circuit Breakers for PowerFlex 527

### 100...120V 1-Phase Input Protection Devices - Frames A...B – IEC (Non-UL) Applications

Catalog No. <sup>(1)</sup>	Output Ratings				Input Ratings			Frame Size	Contactor Cat. No.	IEC (Non-UL) Applications			
	ND		HD		A	kVA	Max Current A <sup>(2)</sup>			Fuses (Rating)		Circuit Breakers	
	Hp	kW	Hp	kW						Min	Max	140U	140M/140MT <sup>(3)(4)(5)</sup>
25C-V2P5N104	0.5	0.4	0.5	0.4	2.5	1.3	9.6	A	100-C12	15	20	140U-D6D2-C12	140M-C2E-C10 140MT-D9E-C10
25C-V4P8N104	1.0	0.75	1.0	0.75	4.8	2.5	19.2	B	100-C23	25	40	140U-D6D2-C25	140M-D8E-C20 140MT-D9E-C20
25C-V6P0N104	1.5	1.1	1.5	1.1	6.0	3.2	24.0	B	100-C23	30	50	140U-D6D2-C30	140M-F8E-C25

(1) 150% Overload capability for up to 60 s, 180% for up to 3 s.

(2) When the drive is controlling motors with lower amp ratings, refer to the drive nameplate for drive input current rating.

(3) The AIC ratings of the Bulletin 140M/MT devices can vary. See publication [140-TD005](#) or [140M-TD002](#).

(4) Bulletin 140M/MT with adjustable current range should have the current trip set to the minimum range that the device will not trip.

(5) Manual Self-Protected (Type E) Combination Motor Controller, UL Listed for 480Y/277 and 600Y/347 AC input. Not UL Listed for use on 480V or 600V Delta/Delta, corner ground, or high-resistance ground systems.

### 100...120V 1-Phase Input Protection Devices - Frames A...B – UL 61800-5-1 Applications

Catalog No. <sup>(1)</sup>	Output Ratings				Input Ratings			Frame Size	Contactor Cat. No.	UL 61800-5-1 Applications			
	ND		HD		A	kVA	Max Current A <sup>(2)</sup>			Fuses (Max. Rating)		Circuit Breakers	
	Hp	kW	Hp	kW						Class / Catalog No.	140UT	140M/140MT <sup>(3)(4)(5)</sup>	
25C-V2P5N104	0.5	0.4	0.5	0.4	2.5	1.3	9.6	A	100-C12	CLASS CC, J, or T/20	140UT-D7D2-C12	140MT-C3E-C10 140MT-D9E-C10	
25C-V4P8N104	1.0	0.75	1.0	0.75	4.8	2.5	19.2	B	100-C23	CLASS CC, J, or T/40	— <sup>(6)</sup>	140MT-D9E-C20	
25C-V6P0N104	1.5	1.1	1.5	1.1	6.0	3.2	24.0	B	100-C23	CLASS CC, J, or T/50	— <sup>(6)</sup>	140M-F8E-C25	

(1) 150% Overload capability for up to 60 s, 180% for up to 3 s.

(2) When the drive is controlling motors with lower amp ratings, refer to the drive nameplate for drive input current rating.

(3) The AIC ratings of the Bulletin 140M/MT devices can vary. See publication [140-TD005](#) or [140M-TD002](#).

(4) Bulletin 140M/MT with adjustable current range should have the current trip set to the minimum range that the device will not trip.

(5) Manual Self-Protected (Type E) Combination Motor Controller, UL Listed for 480Y/277 and 600Y/347 AC input. Not UL Listed for use on 480V or 600V Delta/Delta, corner ground, or high-resistance ground systems.

(6) Circuit breaker selection is not available for this drive rating.

### 200...240V 1-Phase Input Protection Devices - Frames A...B – IEC (Non-UL) Applications

Catalog No. <sup>(1)</sup>	Output Ratings				Input Ratings			Frame Size	Contactor Cat. No.	IEC (Non-UL) Applications			
	ND		HD		A	kVA	Max Current A <sup>(2)</sup>			Fuses (Rating)		Circuit Breakers	
	Hp	kW	Hp	kW						Min	Max	140U	140M/140MT <sup>(3)(4)(5)</sup>
25C-A2P5N104	0.5	0.4	0.5	0.4	2.5	1.7	6.5	A	100-C09	10	15	140U-D6D2-C10	140M-C2E-C10 140MT-D9E-C10
25C-A2P5N114	0.5	0.4	0.5	0.4	2.5	1.7	6.5	A	100-C09	10	15	140U-D6D2-C10	140M-C2E-C10 140MT-D9E-C10
25C-A4P8N104	1.0	0.75	1.0	0.75	4.8	2.8	10.7	A	100-C12	15	25	140U-D6D2-C15	140M-C2E-C16 140MT-D9E-C16
25C-A4P8N114	1.0	0.75	1.0	0.75	4.8	2.8	10.7	A	100-C12	15	25	140U-D6D2-C15	140M-C2E-C16 140MT-D9E-C16
25C-A8P0N104	2.0	1.5	2.0	1.5	8.0	4.8	18.0	B	100-C23	25	40	140U-D6D2-C25	140M-F8E-C25
25C-A8P0N114	2.0	1.5	2.0	1.5	8.0	4.8	18.0	B	100-C23	25	40	140U-D6D2-C25	140M-F8E-C25
25C-A011N104	3.0	2.2	3.0	2.2	11.0	6.0	22.9	B	100-C37	30	50	140U-H6C2-C35	140M-F8E-C25
25C-A011N114	3.0	2.2	3.0	2.2	11.0	6.0	22.9	B	100-C37	30	50	140U-H6C2-C35	140M-F8E-C25

(1) 150% Overload capability for up to 60 s, 180% for up to 3 s.

(2) When the drive is controlling motors with lower amp ratings, refer to the drive nameplate for drive input current rating.

(3) The AIC ratings of the Bulletin 140M/MT devices can vary. See publication [140-TD005](#) or [140M-TD002](#).

(4) Bulletin 140M/MT with adjustable current range should have the current trip set to the minimum range that the device will not trip.

(5) Manual Self-Protected (Type E) Combination Motor Controller, UL Listed for 480Y/277 and 600Y/347 AC input. Not UL Listed for use on 480V or 600V Delta/Delta, corner ground, or high-resistance ground systems.

200...240V 1-Phase Input Protection Devices – Frames A...B – UL 61800-5-1 Applications

Catalog No. (1)	Output Ratings				Input Ratings			Frame Size	Contactor Cat. No.	UL 61800-5-1 Applications			
	ND		HD		A	kVA	Max Current A(2)			Fuses (Max. Rating)		Circuit Breakers	
	Hp	kW	Hp	kW						Class / Catalog No.	140UT	140M/140MT(3)(4)(5)	
25C-A2P5N104	0.5	0.4	0.5	0.4	2.5	1.7	6.5	A	100-C09	CLASS CC, J, or T/15	140UT-D7D2-C10	140MT-D9E-C10	
25C-A2P5N114	0.5	0.4	0.5	0.4	2.5	11.7	6.5	A	100-C09	CLASS CC, J, or T/15	140UT-D7D2-C10	140MT-D9E-C10	
25C-A4P8N104	1.0	0.75	1.0	0.75	4.8	2.8	10.7	A	100-C12	CLASS CC, J, or T/25	140UT-D7D2-C15	140MT-D9E-C16	
25C-A4P8N114	1.0	0.75	1.0	0.75	4.8	2.8	10.7	A	100-C12	CLASS CC, J, or T/25	140UT-D7D2-C15	140MT-D9E-C16	
25C-A8P0N104	2.0	1.5	2.0	1.5	8.0	4.8	18.0	B	100-C23	CLASS CC, J, or T/40	— (6)	140M-F8E-C25	
25C-A8P0N114	2.0	1.5	2.0	1.5	8.0	4.8	18.0	B	100-C23	CLASS CC, J, or T/40	— (6)	140M-F8E-C25	
25C-A011N104	3.0	2.2	3.0	2.2	11.0	6.0	22.9	B	100-C37	CLASS CC, J, or T/50	— (6)	140M-F8E-C25	
25C-A011N114	3.0	2.2	3.0	2.2	11.0	6.0	22.9	B	100-C37	CLASS CC, J, or T/50	— (6)	140M-F8E-C25	

- (1) 150% Overload capability for up to 60 s, 180% for up to 3 s.
- (2) When the drive is controlling motors with lower amp ratings, refer to the drive nameplate for drive input current rating.
- (3) The AIC ratings of the Bulletin 140M/MT devices can vary. See publication [140-TD005](#) or [140M-TD002](#).
- (4) Bulletin 140M/MT with adjustable current range should have the current trip set to the minimum range that the device will not trip.
- (5) Manual Self-Protected (Type E) Combination Motor Controller, UL Listed for 480Y/277 and 600Y/347 AC input. Not UL Listed for use on 480V or 600V Delta/Delta, corner ground, or high-resistance ground systems.
- (6) Circuit breaker selection is not available for this drive rating.

200...240V 3-Phase Input Protection Devices – Frames A...B – IEC (Non-UL) Applications

Catalog No.	Output Ratings				Input Ratings			Frame Size	Contactor Cat. No.	IEC (Non-UL) Applications			
	ND		HD		A	kVA	Max Current A(1)			Fuses (Rating)		Circuit Breakers	
	Hp	kW	Hp	kW						Min	Max	140U	140M/140MT(2)(3)(4)
25C-B2P5N104(5)	0.5	0.4	0.5	0.4	2.5	1.2	2.7	A	100-C07	6	6	140U-D6D3-B40	140M-C2E-B40 140MT-D9E-B40
25C-B5P0N104(5)	1.0	0.75	1.0	0.75	5.0	2.7	5.8	A	100-C09	10	15	140U-D6D3-B80	140M-C2E-B63 140MT-D9E-B63
25C-B8P0N104(5)	2.0	1.5	2.0	1.5	8.0	4.3	9.5	A	100-C12	15	20	140U-D6D3-C10	140M-C2E-C10 140MT-D9E-C10
25C-B011N104(5)	3.0	2.2	3.0	2.2	11.0	6.3	13.8	A	100-C23	20	30	140U-D6D3-C15	140M-C2E-C16 140MT-D9E-C16
25C-B017N104(5)	5.0	4.0	5.0	4.0	17.5	9.6	21.1	B	100-C23	30	45	140U-D6D3-C25	140M-F8E-C25
25C-B024N104(5)	7.5	5.5	7.5	5.5	24.0	12.2	26.6	C	100-C37	35	60	140U-H6C3-C35	140M-F8E-C32
25C-B032N104(5)	10.0	7.5	10.0	7.5	32.2	15.9	34.8	D	100-C43	45	70	140U-H6C3-C60	140M-F8E-C45
25C-B048N104(6)	15.0	11.0	10.0	7.5	48.3	20.1	44.0	E	100-C60	60	90	140U-H6C3-C70	140M-F8E-C45
25C-B062N104(6)	20.0	15.0	15.0	11.0	62.1	25.6	56.0	E	100-C72	70	125	140U-H6C3-C90	140M-H8P-C70

- (1) When the drive is controlling motors with lower amp ratings, refer to the drive nameplate for drive input current rating.
- (2) The AIC ratings of the Bulletin 140M/MT devices can vary. See publication [140-TD005](#) or [140M-TD002](#).
- (3) Bulletin 140M/MT with adjustable current range should have the current trip set to the minimum range that the device will not trip.
- (4) Manual Self-Protected (Type E) Combination Motor Controller, UL Listed for 480Y/277 and 600Y/347 AC input. Not UL Listed for use on 480V or 600V Delta/Delta, corner ground, or high-resistance ground systems.
- (5) 150% Overload capability for up to 60 s, 180% for up to 3 s.
- (6) ■ 110% Overload capability for up to 60 s, 150% for up to 3 s.

## 200...240V 3-Phase Input Protection Devices - Frames A...E – UL 61800-5-1 Applications

Catalog No.	Output Ratings				Input Ratings			Frame Size	Contactor Cat. No.	UL 61800-5-1 Applications			
	ND		HD		A	kVA	Max Current A <sup>(1)</sup>			Fuses (Max. Rating)		Circuit Breakers	
	Hp	kW	Hp	kW						Class / Catalog No.	140UT	140M/140MT <sup>(2)(3)(4)</sup>	
25C-B2P5N104 <sup>(5)</sup>	0.5	0.4	0.5	0.4	2.5	1.2	2.7	A	100-C07	CLASS CC, J, or T/6	140UT-D7D3-B40	140MT-D9E-B40	
25C-B5P0N104 <sup>(5)</sup>	1.0	0.75	1.0	0.75	5.0	2.7	5.8	A	100-C09	CLASS CC, J, or T/15	140UT-D7D3-B80	140MT-D9E-B63	
25C-B8P0N104 <sup>(5)</sup>	2.0	1.5	2.0	1.5	8.0	4.3	9.5	A	100-C12	CLASS CC, J, or T/20	140UT-D7D3-C10	140MT-D9E-C10	
25C-B011N104 <sup>(5)</sup>	3.0	2.2	3.0	2.2	11.0	6.3	13.8	A	100-C23	CLASS CC, J, or T/30	140UT-D7D3-C15	140MT-D9E-C16	
25C-B017N104 <sup>(5)</sup>	5.0	4.0	5.0	4.0	17.5	9.6	21.1	B	100-C23	CLASS CC, J, or T/45	140UT-D7D3-C25	140M-F8E-C25	
25C-B024N104 <sup>(5)</sup>	7.5	5.5	7.5	5.5	24.0	12.2	26.6	C	100-C37	CLASS CC, J, or T/60	— <sup>(6)</sup>	140M-F8E-C32	
25C-B032N104 <sup>(5)</sup>	10.0	7.5	10.0	7.5	32.2	15.9	34.8	D	100-C43	CLASS CC, J, or T/70	— <sup>(6)</sup>	140M-F8E-C45	
25C-B048N104 <sup>(7)</sup>	15.0	11.0	10.0	7.5	48.3	20.1	44.0	E	100-C60	CLASS CC, J, or T/90	— <sup>(6)</sup>	140M-F8E-C45	
25C-B062N104 <sup>(7)</sup>	20.0	15.0	15.0	11.0	62.1	25.6	56.0	E	100-C72	CLASS CC, J, or T/125	— <sup>(6)</sup>	140M-H8P-C70	

(1) When the drive is controlling motors with lower amp ratings, refer to the drive nameplate for drive input current rating.

(2) The AIC ratings of the Bulletin 140M/MT devices can vary. See publication [140-TD005](#) or [140M-TD002](#).

(3) Bulletin 140M/MT with adjustable current range should have the current trip set to the minimum range that the device will not trip.

(4) Manual Self-Protected (Type E) Combination Motor Controller, UL Listed for 480Y/277 and 600Y/347 AC input. Not UL Listed for use on 480V or 600V Delta/Delta, corner ground, or high-resistance ground systems.

(5) 150% Overload capability for up to 60 s, 180% for up to 3 s.

(6) Circuit breaker selection is not available for this drive rating.

(7) 110% Overload capability for up to 60 s, 150% for up to 3 s.

## 380...480V 3-Phase Input Protection Devices - Frames A...E – IEC (Non-UL) Applications

Catalog No	Output Ratings				Input Ratings			Frame Size	Contactor Cat. No.	IEC (Non-UL) Applications			
	ND		HD		A	kVA	Max Current A <sup>(1)</sup>			Fuses (Rating)		Circuit Breakers	
	Hp	kW	Hp	kW						Min	Max	140U	140M/MT <sup>(2)(3)(4)</sup>
25C-D1P4N104 <sup>(5)</sup>	0.5	0.4	0.5	0.4	1.4	1.7	1.9	A	100-C07	3	6	140U-D6D3-B30	140M-C2E-B25 140MT-C3E-B25
25C-D1P4N114 <sup>(5)</sup>	0.5	0.4	0.5	0.4	1.4	1.7	1.9	A	100-C07	3	6	140U-D6D3-B30	140M-C2E-B25 140MT-C3E-B25
25C-D2P3N104 <sup>(5)</sup>	1.0	0.75	1.0	0.75	2.3	2.9	3.2	A	100-C07	6	10	140U-D6D3-B60	140M-C2E-B40 140MT-C3E-B40
25C-D2P3N114 <sup>(5)</sup>	1.0	0.75	1.0	0.75	2.3	2.9	3.2	A	100-C07	6	10	140U-D6D3-B60	140M-C2E-B40 140MT-C3E-B40
25C-D4P0N104 <sup>(5)</sup>	2.0	1.5	2.0	1.5	4.0	5.2	5.7	A	100-C09	10	15	140U-D6D3-B60	140M-C2E-B63 40MT-C3E-B63
25C-D4P0N114 <sup>(5)</sup>	2.0	1.5	2.0	1.5	4.0	5.2	5.7	A	100-C09	10	15	140U-D6D3-B60	140M-C2E-B63 40MT-C3E-B63
25C-D6P0N104 <sup>(5)</sup>	3.0	2.2	3.0	2.2	6.0	6.9	7.5	A	100-C09	10	15	140U-D6D3-C10	140M-C2E-C10 140MT-C3E-C10
25C-D6P0N114 <sup>(5)</sup>	3.0	2.2	3.0	2.2	6.0	6.9	7.5	A	100-C09	10	15	140U-D6D3-C10	140M-C2E-C10 140MT-C3E-C10
25C-D010N104 <sup>(5)</sup>	5.0	4.0	5.0	4.0	10.5	12.6	13.8	B	100-C23	20	30	140U-D6D3-C15	140M-C2E-C16 140MT-D9E-C16
25C-D010N114 <sup>(5)</sup>	5.0	4.0	5.0	4.0	10.5	12.6	13.8	B	100-C23	20	30	140U-D6D3-C15	140M-C2E-C16 140MT-D9E-C16
25C-D013N104 <sup>(5)</sup>	7.5	5.5	7.5	5.5	13.0	14.1	15.4	C	100-C23	20	35	140U-D6D3-C25	140M-D8E-C20 140MT-D9E-C20
25C-D013N114 <sup>(5)</sup>	7.5	5.5	7.5	5.5	13.0	14.1	15.4	C	100-C23	20	35	140U-D6D3-C25	140M-D8E-C20 140MT-D9E-C20
25C-D017N104 <sup>(5)</sup>	10.0	7.5	10.0	7.5	17.0	16.8	18.4	C	100-C23	25	40	140U-D6D3-C25	140M-D8E-C20 140MT-D9E-C20
25C-D017N114 <sup>(5)</sup>	10.0	7.5	10.0	7.5	17.0	16.8	18.4	C	100-C23	25	40	140U-D6D3-C25	140M-D8E-C20 140MT-D9E-C20
25C-D024N104 <sup>(5)</sup>	15.0	11.0	15.0	11.0	24.0	24.1	26.4	D	100-C37	35	60	140U-H6C3-C40	140M-F8E-C32
25C-D024N114 <sup>(5)</sup>	15.0	11.0	15.0	11.0	24.0	24.1	26.4	D	100-C37	35	60	140U-H6C3-C40	140M-F8E-C32
25C-D030N104 <sup>(6)</sup>	20.0	15.0	15.0	11.0	30.0	30.2	33.0	D	100-C43	45	70	140U-H6C3-C50	140M-F8E-C45
25C-D030N114 <sup>(6)</sup>	20.0	15.0	15.0	11.0	30.0	30.2	33.0	D	100-C43	45	70	140U-H6C3-C50	140M-F8E-C45
25C-D037N114 <sup>(6)</sup>	25.0	18.5	20.0	15.0	37.0	30.8	33.7	E	100-C43	45	70	140U-H6C3-C50	140M-F8E-C45
25C-D043N114 <sup>(6)</sup>	30.0	22.0	25.0	18.5	43.0	35.6	38.9	E	100-C60	50	80	140U-H6C3-C60	140M-F8E-C45

- (1) When the drive is controlling motors with lower ampere ratings, see the drive nameplate for drive input current rating.
- (2) The AIC ratings of the Bulletin 140M/MT devices can vary. See publication [140-TD005](#) or [140M-TD002](#).
- (3) Bulletin 140M/MT with adjustable current range should have the current trip set to the minimum range that the device will not trip.
- (4) Manual Self-Protected (Type E) Combination Motor Controller, UL Listed for 480Y/277 and 600Y/347 AC input. Not UL Listed for use on 480V or 600V Delta/Delta, corner ground, or high-resistance ground systems.
- (5) 150% Overload capability for up to 60 s, 180% for up to 3 s.
- (6)  110% Overload capability for up to 60 s, 150% for up to 3 s.

**380...480V 3-Phase Input Protection Devices - Frames A...E – UL 61800-5-1 Applications**

Catalog No.	Output Ratings					Input Ratings			Frame Size	Contactor Cat. No.	UL 61800-5-1 Applications		
	ND		HD		A	kVA	Max Current A <sup>(1)</sup>	Fuses (Max Rating)			Circuit Breakers		
	Hp	kW	Hp	kW				Class/Catalog No.			140UT <sup>(2)</sup>	140M/MT <sup>(3)(4)(5)</sup>	
25C-D1P4N104 <sup>(6)</sup>	0.5	0.4	0.5	0.4	1.4	1.7	1.9	A	100-C07	CLASS CC, J, or T/6	—	140MT-C3E-B25	
25C-D1P4N114 <sup>(6)</sup>	0.5	0.4	0.5	0.4	1.4	1.7	1.9	A	100-C07	CLASS CC, J, or T/6	—	140MT-C3E-B25	
25C-D2P3N104 <sup>(6)</sup>	1.0	0.75	1.0	0.75	2.3	2.9	3.2	A	100-C07	CLASS CC, J, or T/10	—	140MT-C3E-B40	
25C-D2P3N114 <sup>(6)</sup>	1.0	0.75	1.0	0.75	2.3	2.9	3.2	A	100-C07	CLASS CC, J, or T/10	—	140MT-C3E-B40	
25C-D4P0N104 <sup>(6)</sup>	2.0	1.5	2.0	1.5	4.0	5.2	5.7	A	100-C09	CLASS CC, J, or T/15	—	140MT-C3E-B63	
25C-D4P0N114 <sup>(6)</sup>	2.0	1.5	2.0	1.5	4.0	5.2	5.7	A	100-C09	CLASS CC, J, or T/15	—	140MT-C3E-B63	
25C-D6P0N104 <sup>(6)</sup>	3.0	2.2	3.0	2.2	6.0	6.9	7.5	A	100-C09	CLASS CC, J, or T/15	—	140MT-C3E-C10	
25C-D6P0N114 <sup>(6)</sup>	3.0	2.2	3.0	2.2	6.0	6.9	7.5	A	100-C09	CLASS CC, J, or T/15	—	140MT-C3E-C10	
25C-D010N104 <sup>(6)</sup>	5.0	4.0	5.0	4.0	10.5	12.6	13.8	B	100-C23	CLASS CC, J, or T/30	—	140MT-D9E-C16	
25C-D010N114 <sup>(6)</sup>	5.0	4.0	5.0	4.0	10.5	12.6	13.8	B	100-C23	CLASS CC, J, or T/30	—	140MT-D9E-C16	
25C-D013N104 <sup>(6)</sup>	7.5	5.5	7.5	5.5	13.0	14.1	15.4	C	100-C23	CLASS CC, J, or T/35	—	140MT-D9E-C20	
25C-D013N114 <sup>(6)</sup>	7.5	5.5	7.5	5.5	13.0	14.1	15.4	C	100-C23	CLASS CC, J, or T/35	—	140MT-D9E-C20	
25C-D017N104 <sup>(6)</sup>	10.0	7.5	10.0	7.5	17.0	16.8	18.4	C	100-C23	CLASS CC, J, or T/40	—	140MT-D9E-C20	
25C-D017N114 <sup>(6)</sup>	10.0	7.5	10.0	7.5	17.0	16.8	18.4	C	100-C23	CLASS CC, J, or T/40	—	140MT-D9E-C20	
25C-D024N104 <sup>(6)</sup>	15.0	11.0	15.0	11.0	24.0	24.1	26.4	D	100-C37	CLASS CC, J, or T/60	—	140M-F8E-C32	
25C-D024N114 <sup>(6)</sup>	15.0	11.0	15.0	11.0	24.0	24.1	26.4	D	100-C37	CLASS CC, J, or T/60	—	140M-F8E-C32	
25C-D030N104 <sup>(7)</sup>	20.0	15.0	15.0	11.0	30.0	30.2	33.0	D	100-C43	CLASS CC, J, or T/70	—	140M-F8E-C45	
25C-D030N114 <sup>(7)</sup>	20.0	15.0	15.0	11.0	30.0	30.2	33.0	D	100-C43	CLASS CC, J, or T/70	—	140M-F8E-C45	
25C-D037N114 <sup>(7)</sup>	25.0	18.5	20.0	15.0	37.0	30.8	33.7	E	100-C43	CLASS CC, J, or T/70	—	140M-F8E-C45	
25C-D043N114 <sup>(7)</sup>	30.0	22.0	25.0	18.5	43.0	35.6	38.9	E	100-C60	CLASS CC, J, or T/80	—	140M-F8E-C45	

- (1) When the drive is controlling motors with lower ampere ratings, see the drive nameplate for drive input current rating.
- (2) Circuit breaker selection is not available for this drive rating.
- (3) The AIC ratings of the Bulletin 140M/MT devices can vary. See publication [140-TD005](#) or [140M-TD002](#).
- (4) Bulletin 140M/MT with adjustable current range should have the current trip set to the minimum range that the device will not trip.
- (5) Manual Self-Protected (Type E) Combination Motor Controller, UL Listed for 480Y/277 and 600Y/347 AC input. Not UL Listed for use on 480V or 600V Delta/Delta, corner ground, or high-resistance ground systems.
- (6) 150% Overload capability for up to 60 s, 180% for up to 3 s.
- (7)  110% Overload capability for up to 60 s, 150% for up to 3 s.

**525...600V 3-Phase Input Protection Devices - Frames A...E – IEC (Non-UL) Applications**

Catalog No.	Output Ratings					Input Ratings			Frame Size	Contactor Cat. No.	IEC (Non-UL) Applications			
	ND		HD		A	kVA	Max Current A <sup>(1)</sup>	Fuses (Rating)			Circuit Breakers			
	Hp	kW	Hp	kW				Min			Max	140U/140G	140M/MT <sup>(2)(3)(4)</sup>	
25C-E0P9N104 <sup>(5)</sup>	0.5	0.4	0.5	0.4	0.9	1.4	1.2	A	100-C09	3	6	140U-D6D3-B20	140M-C2E-B25 140MT-C3E-B25	
25C-E1P7N104 <sup>(5)</sup>	1.0	0.75	1.0	0.75	1.7	2.6	2.3	A	100-C09	3	6	140U-D6D3-B30	140M-C2E-B25 140MT-C3E-B25	
25C-E3P0N104 <sup>(5)</sup>	2.0	1.5	2.0	1.5	3.0	4.3	3.8	A	100-C09	6	10	140U-D6D3-B50	140M-C2E-B40 140MT-C3E-B40	
25C-E4P2N104 <sup>(5)</sup>	3.0	2.2	3.0	2.2	4.2	6.1	5.3	A	100-C09	10	15	140U-D6D3-B80	140M-C2E-B63 140MT-D9E-B63	
25C-E6P6N104 <sup>(5)</sup>	5.0	4.0	5.0	4.0	6.6	9.1	8.0	B	100-C09	10	20	140U-D6D3-C10	140M-C2E-C10 140MT-D9E-C10	
25C-E9P9N104 <sup>(5)</sup>	7.5	5.5	7.5	5.5	9.9	12.8	11.2	C	100-C16	15	25	140U-D6D3-C15	140M-C2E-C16 140MT-D9E-C16	
25C-E012N104 <sup>(5)</sup>	10.0	7.5	10.0	7.5	12.0	15.4	13.5	C	100-C23	20	30	140U-D6D3-C20	140M-C2E-C16 140MT-D9E-C16	

## 525...600V 3-Phase Input Protection Devices - Frames A...E – IEC (Non-UL) Applications (Continued)

Catalog No.	Output Ratings				Input Ratings			Frame Size	Contactor Cat. No.	IEC (Non-UL) Applications			
	ND		HD		A	kVA	Max Current A <sup>(1)</sup>			Fuses (Rating)		Circuit Breakers	
	Hp	kW	Hp	kW						Min	Max	140U/140G	140M/MT <sup>(2)(3)(4)</sup>
25C-E019N104 <sup>(5)</sup>	15.0	11.0	15.0	11.0	19.0	27.4	24.0	D	100-C30	30	50	140U-H6C3-C30	140M-F8E-C25
25C-E022N104 <sup>(6)</sup>	20.0	15.0	15.0	11.0	22.0	31.2	27.3	D	100-C30	35	60	140U-H6C3-C35	140M-F8E-C32
25C-E027N104 <sup>(6)</sup>	25.0	18.5	20.0	15.0	27.0	28.2	24.7	E	100-C30	35	50	140U-H6C3-C35	140M-F8E-C32
25C-E032N104 <sup>(6)</sup>	30.0	22.0	25.0	18.5	32.0	33.4	29.2	E	100-C37	40	60	140U-H6C3-C50	140M-F8E-C32

(1) When the drive is controlling motors with lower ampere ratings, see the drive nameplate for drive input current rating.

(2) The AIC ratings of the Bulletin 140M/MT devices can vary. See publication [140-TD005](#) or [140M-TD002](#).

(3) Bulletin 140M/MT with adjustable current range should have the current trip set to the minimum range that the device will not trip.

(4) Manual Self-Protected (Type E) Combination Motor Controller, UL Listed for 480Y/277 and 600Y/347 AC input. Not UL Listed for use on 480V or 600V Delta/Delta, corner ground, or high-resistance ground systems.

(5) 150% Overload capability for up to 60 s, 180% for up to 3 s.

(6)  110% Overload capability for up to 60 s, 150% for up to 3 s.

## 525...600V 3-Phase Input Protection Devices - Frames A...E – UL 61800-5-1 Applications

Catalog No.	Output Ratings				Input Ratings			Frame Size	Contactor Cat. No.	UL 61800-5-1 Applications			
	ND		HD		A	kVA	Max Current A <sup>(1)</sup>			Fuses (Max Rating)		Circuit Breakers	
	Hp	kW	Hp	kW						Class/Catalog No.	140UT <sup>(2)</sup>	140M/MT <sup>(3)(4)(5)</sup>	
25C-E0P9N104 <sup>(6)</sup>	0.5	0.4	0.5	0.4	0.9	1.4	1.2	A	100-C09	CLASS CC, J, or T/6	—	140MT-C3E-B25	
25C-E1P7N104 <sup>(6)</sup>	1.0	0.75	1.0	0.75	1.7	2.6	2.3	A	100-C09	CLASS CC, J, or T/6	—	140MT-C3E-B25	
25C-E3P0N104 <sup>(6)</sup>	2.0	1.5	2.0	1.5	3.0	4.3	3.8	A	100-C09	CLASS CC, J, or T/10	—	140MT-C3E-B40	
25C-E4P2N104 <sup>(6)</sup>	3.0	2.2	3.0	2.2	4.2	6.1	5.3	A	100-C09	CLASS CC, J, or T/15	—	140MT-D9E-B63	
25C-E6P6N104 <sup>(6)</sup>	5.0	4.0	5.0	4.0	6.6	9.1	8.0	B	100-C09	CLASS CC, J, or T/20	—	140MT-D9E-C10	
25C-E9P9N104 <sup>(6)</sup>	7.5	5.5	7.5	5.5	9.9	12.8	11.2	C	100-C16	CLASS CC, J, or T/25	—	140MT-D9E-C16	
25C-E012N104 <sup>(6)</sup>	10.0	7.5	10.0	7.5	12.0	15.4	13.5	C	100-C23	CLASS CC, J, or T/30	—	140MT-D9E-C16	
25C-E019N104 <sup>(6)</sup>	15.0	11.0	15.0	11.0	19.0	27.4	24.0	D	100-C30	CLASS CC, J, or T/50	—	140M-F8E-C25	
25C-E022N104 <sup>(7)</sup>	20.0	15.0	15.0	11.0	22.0	31.2	27.3	D	100-C30	CLASS CC, J, or T/60	—	140M-F8E-C32	
25C-E027N104 <sup>(7)</sup>	25.0	18.5	20.0	15.0	27.0	28.2	24.7	E	100-C30	CLASS CC, J, or T/50	—	140M-F8E-C32	
25C-E032N104 <sup>(7)</sup>	30.0	22.0	25.0	18.5	32.0	33.4	29.2	E	100-C37	CLASS CC, J, or T/60	—	140M-F8E-C32	

(1) When the drive is controlling motors with lower ampere ratings, see the drive nameplate for drive input current rating.

(2) Circuit breaker selection is not available for this drive rating.

(3) The AIC ratings of the Bulletin 140M/MT devices can vary. See publication [140-TD005](#) or [140M-TD002](#).

(4) Bulletin 140M/MT with adjustable current range should have the current trip set to the minimum range that the device will not trip.

(5) Manual Self-Protected (Type E) Combination Motor Controller, UL Listed for 208V Wye or Delta, 240V Wye or Delta, 480V Y/277 or 600V Y/347. Not UL Listed for use on 480V or 600V Delta/Delta, corner ground, or high-resistance ground systems.

(6) 150% Overload capability for up to 60 s, 180% for up to 3 s.

(7)  110% Overload capability for up to 60 s, 150% for up to 3 s.

## Power and Control Module

PowerFlex 527 drives consist of a Power Module and Control Module. This section describes how to separate the two modules and reconnect them back together, and also how to access the power terminals and control terminals. It is assumed that your drive is new and has not been installed.



**ATTENTION:** If you are performing these steps on a drive that has been installed, verify that the drive is powered down and the DC Bus voltage is less than 50V DC before proceeding.

### Separating the Power and Control Module

1. Press and hold down the catch on both sides of the frame cover, then pull out and swing upwards to remove (Frames B...E only).

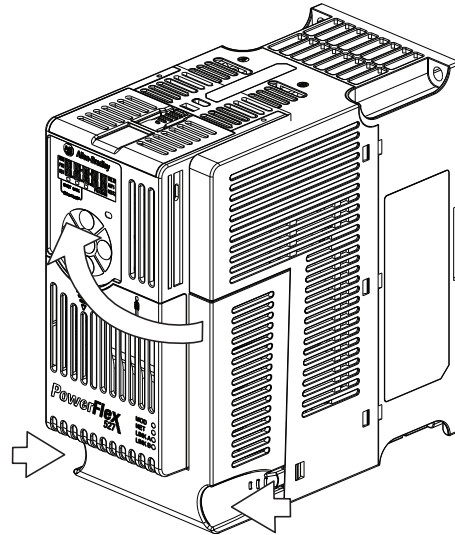

2. Press down and slide out the top cover of the Control Module to unlock it from the Power Module.

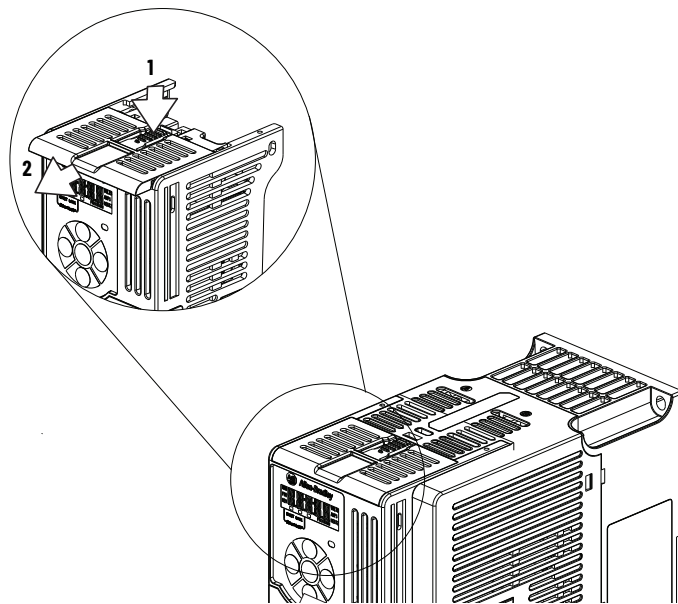

3. Hold the sides and top of the Control Module firmly, then pull out to separate it from the Power Module.

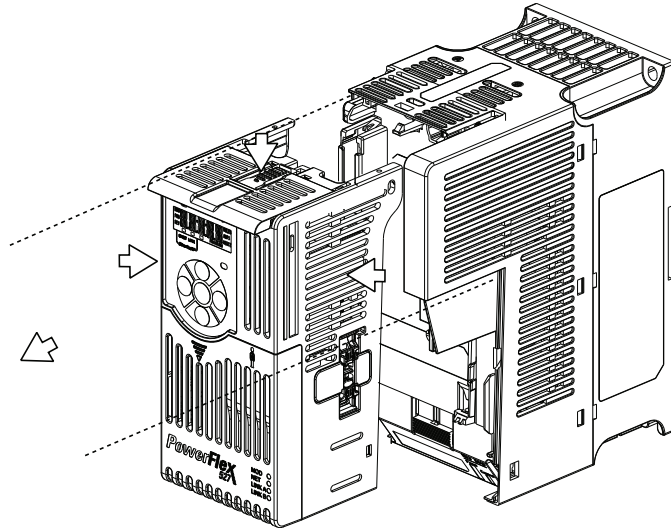

#### *Connecting the Power and Control Module*

1. Align the connectors on the Power Module and Control Module, then push the Control Module firmly onto the Power Module.

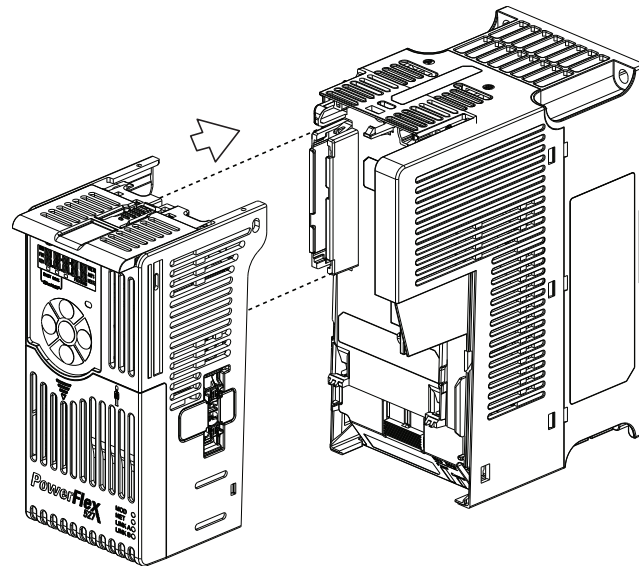



2. Push the top cover of the Control Module towards the Power Module to lock it.

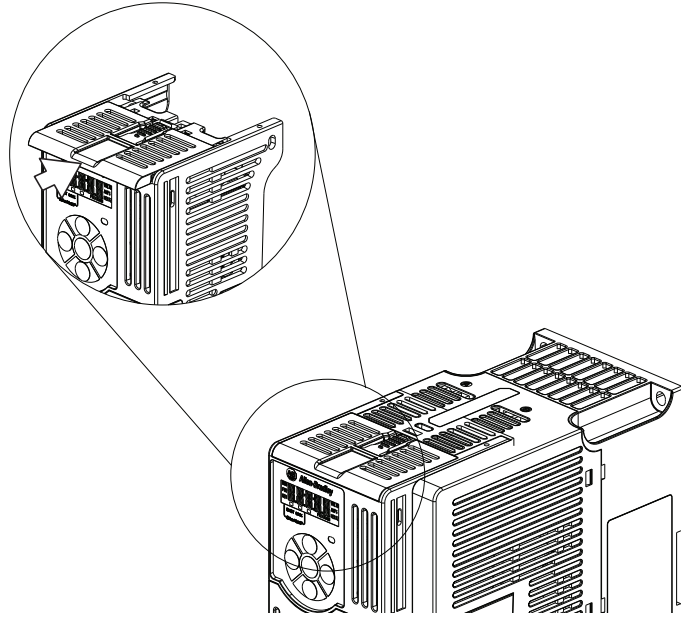

3. Insert the catch at the top of the frame cover into the Power Module, then swing the frame cover to snap the side catches onto the Power Module (Frames B...E only).

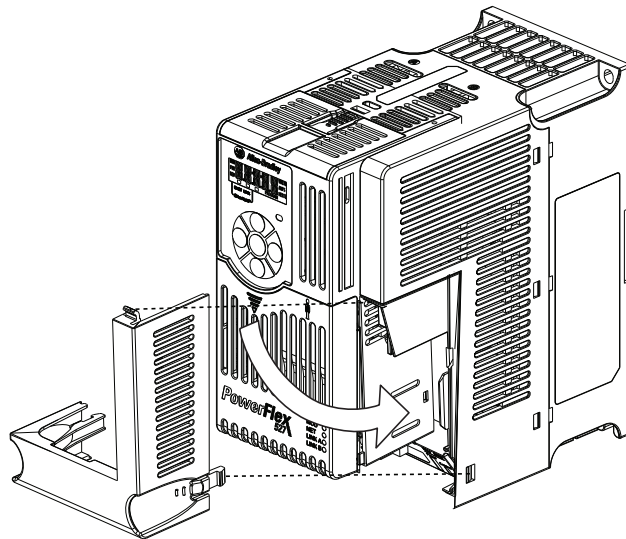

## Control Module Cover

To access the control terminals, the front cover must be removed. To remove:

1. Press and hold down the arrow on the front of the cover.
2. Slide the front cover down to remove from the Control Module.

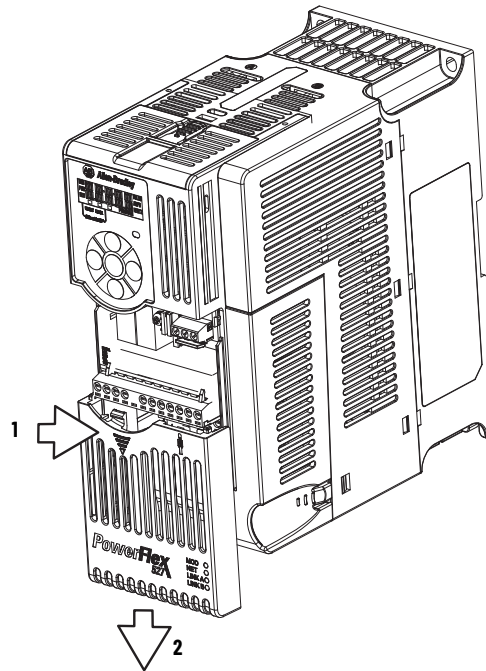

Reattach the front cover when wiring is complete.

## Power Module Terminal Guard

To access the power terminals, the terminal guard must be removed. To remove:

1. Press and hold down the catch on both sides of the frame cover, then pull out and swing upwards to remove (Frames B...E only).

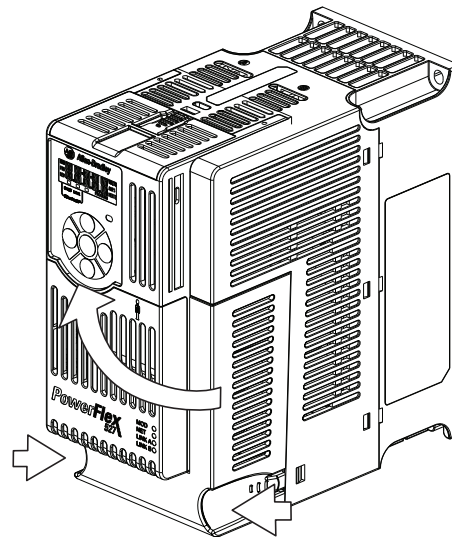

2. Press and hold down the locking tab on the terminal guard.

- Slide the terminal guard down to remove from the Power Module.

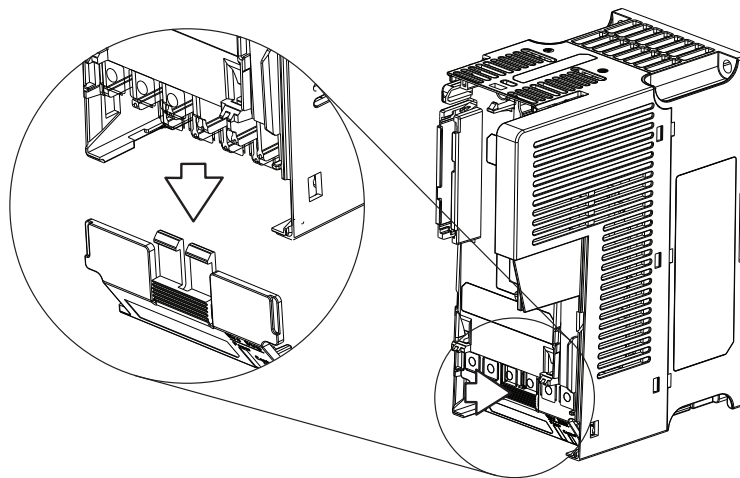

Reattach the terminal guard when wiring is complete.

To access the power terminals for Frame A, you need to separate the Power and Control Modules. See [Separating the Power and Control Module on page 26](#) for instructions.

## Power Wiring

For general wiring and grounding practices, see the Wiring and Grounding for Pulse Width Modulated (PWM) AC Drives Installation Instructions, publication [DRIVES-IN001](#).



### ATTENTION:

- National Codes and standards (NEC, VDE, BSI, and so on) and local codes outline provisions for safely installing electrical equipment. Installation must comply with specifications regarding wire types, conductor sizes, branch circuit protection, and disconnect devices. Failure to do so may result in personal injury and/or equipment damage.
- To avoid a possible shock hazard that is caused by induced voltages, unused wires in the conduit must be grounded at both ends. For the same reason, if a drive sharing a conduit is being serviced or installed, all drives using this conduit should be disabled. This will help minimize the possible shock hazard from “cross coupled” power leads.

## Motor Cable Types Acceptable for 100...600 Volt Installations

A variety of cable types are acceptable for drive installations. For many installations, unshielded cable is adequate, provided it can be separated from sensitive circuits. As an approximate guide, allow a spacing of 0.3 m (1 ft) for every 10 m (32.8 ft) of length. In all cases, long parallel runs must be avoided. Do not use cable with an insulation thickness less than 15 mils (0.4 mm/0.015 in.). Do not route more than three sets of motor leads in one conduit to minimize “cross talk”. If more than three drive/motor connections per conduit are required, shielded cable must be used.

- UL installations above 50 °C (122 °F) ambient must use 600V, 90 °C (194 °F) wire.
- UL installations in 50 °C (122 °F) ambient must use 600V, 75 °C or 90 °C (167 °F or 194 °F) wire.
- UL installations in 40 °C (104 °F) ambient should use 600V, 75 °C or 90 °C (167 °F or 194 °F) wire.

Use copper wire only. Wire gauge requirements and recommendations are tables that are provided on 75 °C (167 °F). Do not reduce wire gauge when using higher temperature wire.



**ATTENTION:** The distance between the drive and motor must not exceed the maximum cable length that is stated in the Motor Cable Length Restrictions Tables in the Wiring and Grounding for Pulse Width Modulated (PWM) AC Drives Installation Instructions, publication [DRIVES-IN001](#).

### *Unshielded*

THHN, THWN, or similar wire is acceptable for drive installation in dry environments provided adequate free air space and/or conduit fill rate limits are provided. Any wire that is chosen must have a minimum insulation thickness of 15 mils and should not have large variations in insulation concentricity.



**ATTENTION:** Do not use THHN or similarly coated wire in wet areas.

### *Shielded/Armored Cable*

Shielded cable contains all the general benefits of multi-conductor cable with the added benefit of a copper braided shield that can contain much of the noise that is generated by a typical AC Drive. Strong consideration for shielded cable should be given in installations with sensitive equipment such as weigh scales, capacitive proximity switches, and other devices that may be affected by electrical noise in the distribution system. Applications with large numbers of drives in a similar location, imposed EMC regulations or a high degree of communications / networking are also good candidates for shielded cable.

Shielded cable may also help reduce shaft voltage and induced bearing currents for some applications. In addition, the increased impedance of shielded cable may help extend the distance that the motor can be located from the drive without the addition of motor protective devices such as terminator networks. See Reflected Wave in the Wiring and Grounding for Pulse Width Modulated (PWM) AC Drives Installation Instructions, publication [DRIVES-IN001](#).

Consideration should be given to all general specifications dictated by the environment of the installation, including temperature, flexibility, moisture characteristics, and chemical resistance. In addition, a braided shield should be included and be specified by the cable manufacturer as having coverage of at least 75%. An additional foil shield can greatly improve noise containment.

A good example of recommended cable is Belden® 295xx (xx determines gauge). This cable has four XLPE insulated conductors with a 100% coverage foil and an 85% coverage copper braided shield surrounded by a PVC jacket.

Other types of shielded cable are available, but the selection of these types may limit the allowable cable length. Particularly, some of the newer cables twist four conductors of THHN wire and wrap them tightly with a foil shield. This construction can greatly increase the cable charging current required and reduce the overall drive performance. Unless specified in the individual distance tables as tested with the drive, these cables are not recommended and their performance against the lead length limits supplied is not known.

### Recommended Shielded Wire

Location	Rating/Type	Description
Standard (Option 1)	600V, 90 °C (194 °F) XHHW2/RHW-2 Anixter B209500-B209507, Belden 29501-29507, or equivalent	<ul style="list-style-type: none"> <li>• Four tinned copper conductors with XLPE insulation.</li> <li>• Copper braid/aluminum foil combination shield and tinned copper drain wire.</li> <li>• PVC jacket.</li> </ul>
Standard (Option 2)	Tray rated 600V, 90 °C (194 °F) RHH/RHW-2 Anixter 0LF-7xxxxx or equivalent	<ul style="list-style-type: none"> <li>• Three tinned copper conductors with XLPE insulation.</li> <li>• 5 mil single helical copper tape (25% overlap min.) with three bare copper grounds in contact with shield.</li> <li>• PVC jacket.</li> </ul>
Class I & II; Division I & II	Tray rated 600V, 90 °C (194 °F) RHH/RHW-2 Anixter 7V-7xxxx-3G or equivalent	<ul style="list-style-type: none"> <li>• Three bare copper conductors with XLPE insulation and impervious corrugated continuously welded aluminum armor.</li> <li>• Black sunlight resistant PVC jacket overall.</li> <li>• Three copper grounds on #10 AWG and smaller.</li> </ul>

### Reflected Wave Protection

The drive should be installed as close to the motor as possible. Installations with long motor cables may require the addition of external devices to limit voltage reflections at the motor (reflected wave phenomena). See Reflected Wave in the Wiring and Grounding for Pulse Width Modulated (PWM) AC Drives Installation Instructions, publication [DRIVES-IN001](#).

The reflected wave data applies to all carrier frequencies 2...8 kHz.

**Note:** For 240V ratings and lower, reflected wave effects do not need to be considered.

### Output Disconnect

The drive is intended to be commanded by motion commands that will start and stop the motor. A device that routinely disconnects then reapplies output power to the motor for starting and stopping the motor should not be used. If it is necessary to disconnect power to the motor with the drive outputting power, use the Logix Designer application to disable the drive (Aux Fault or Coast to Stop).

## Power Terminal Block

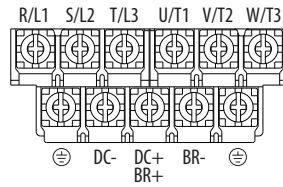

### Power Terminal Block

Frame A, B, C & D

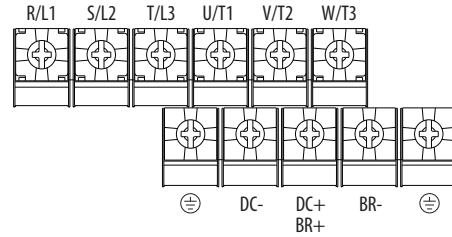

Frame E

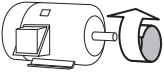

Terminal	Description
R/L1, S/L2	1-Phase Input Line Voltage Connection
R/L1, S/L2, T/L3	3-Phase Input Line Voltage Connection
U/T1, V/T2, W/T3	Motor Phase Connection =  Switch any two motor leads to change forward direction or change the Motion Polarity within Studio 5000 Logix Designer application > Axis Properties > Polarity category.
DC+, DC-	DC Bus Connection
BR+, BR-	Dynamic Brake Resistor Connection
	Safety Ground - PE

**IMPORTANT** Terminal screws may become loose during shipment. Verify that all terminal screws are tightened to the recommended torque before applying power to the drive.

### Power Terminal Block Wire Specifications

Frame	Maximum Wire Size <sup>(1)</sup>	Minimum Wire Size <sup>(1)</sup>	Torque
A	5.3 mm <sup>2</sup> (10 AWG)	0.8 mm <sup>2</sup> (18 AWG)	1.76...2.16 N•m (15.6...19.1 lb•in)
B	8.4 mm <sup>2</sup> (8 AWG)	2.1 mm <sup>2</sup> (14 AWG)	1.76...2.16 N•m (15.6...19.1 lb•in)
C	8.4 mm <sup>2</sup> (8 AWG)	2.1 mm <sup>2</sup> (14 AWG)	1.76...2.16 N•m (15.6...19.1 lb•in)
D	13.3 mm <sup>2</sup> (6 AWG)	5.3 mm <sup>2</sup> (10 AWG)	1.76...2.16 N•m (15.6...19.1 lb•in)
E	26.7 mm <sup>2</sup> (3 AWG)	8.4 mm <sup>2</sup> (8 AWG)	3.09...3.77 N•m (27.3...33.4 lb•in)

(1) Maximum/minimum sizes that the terminal block will accept. These are not recommendations.

## I/O Wiring

### Motor Start/Stop Precautions



**ATTENTION:** A contactor or other device that routinely disconnects and reapplies the AC line to the drive to start and stop the motor can cause drive hardware damage. The drive is designed to use control input signals that will start and stop the motor. If used, the input device must not exceed one operation per minute or drive damage can occur.

Important points to remember about I/O wiring:

- Always use copper wire.
- Wire with an insulation rating of 600V or greater is recommended.
- Control and signal wires should be separated from power wires by at least 0.3 m (1 ft).

**IMPORTANT** I/O terminals labeled “Common” are not referenced to the safety ground (PE) terminal and are designed to greatly reduce common mode interference.



**ATTENTION:** Driving the 4-20 mA analog input from a voltage source could cause component damage. Verify proper configuration before applying input signals.



**ATTENTION:** Due to its control circuitry difference from the PowerFlex 523 and PowerFlex 525 drives, connecting Terminals 01 and 11 on the PowerFlex 527 drive causes an internal short and results in some internal components incurring damage to the control module I/O circuitry.

## Signal and Control Wire Types

Recommendations are for 50 °C (122 °F) ambient temperature.  
75 °C (167 °F) wire must be used for 60 °C (140 °F) ambient temperature.  
90 °C (194 °F) wire must be used for 70 °C (158 °F) ambient temperature.

### Recommended Signal Wire

Signal Type/ Where Used	Belden Wire Types <sup>(1)</sup> (or equivalent)	Description	Min. Insulation Rating
Analog I/O	8760/9460	0.750 mm <sup>2</sup> (18 AWG), twisted pair, 100% shield with drain <sup>(2)</sup>	300V, 60 °C (140 °F)
Remote Pot	8770	0.750 mm <sup>2</sup> (18 AWG), 3 conductor, shielded	
Encoder	9728/9730	0.196 mm <sup>2</sup> (24 AWG), individually shielded pairs	

(1) Stranded or solid wire.

(2) If the wires are short and contained within a cabinet, which has no sensitive circuits, the use of shielded wire may not be necessary, but is always recommended.

### Recommended Control Wire for Digital I/O

Type	Wire Types	Description	Min. Insulation Rating
Unshielded	Per US NEC or applicable national or local code	-	300V, 60 °C (140 °F)
Shielded	Multi-conductor shielded cable such as Belden 8770 (or equivalent)	0.750 mm <sup>2</sup> (18 AWG), 3 conductor, shielded	

## Maximum Control Wire Recommendations

Do not exceed control wiring length of 30 m (100 ft). Control signal cable length is highly dependent on electrical environment and installation practices. To improve noise immunity, the I/O terminal block Common may be connected to ground terminal/protective earth.

## Control I/O Terminal Block

### Control I/O Terminal Block Wire Specifications

Frame	Maximum Wire Size <sup>(1)</sup>	Minimum Wire Size <sup>(1)</sup>	Torque
A...E	1.3 mm <sup>2</sup> (16 AWG)	0.13 mm <sup>2</sup> (26 AWG)	0.71...0.86 N•m (6.2...7.6 lb•in)

(1) Maximum/minimum sizes that the terminal block will accept. These are not recommendations.

# PowerFlex 527 Control I/O Removable Terminal Block

PowerFlex 527 Control I/O Wiring Block Diagram

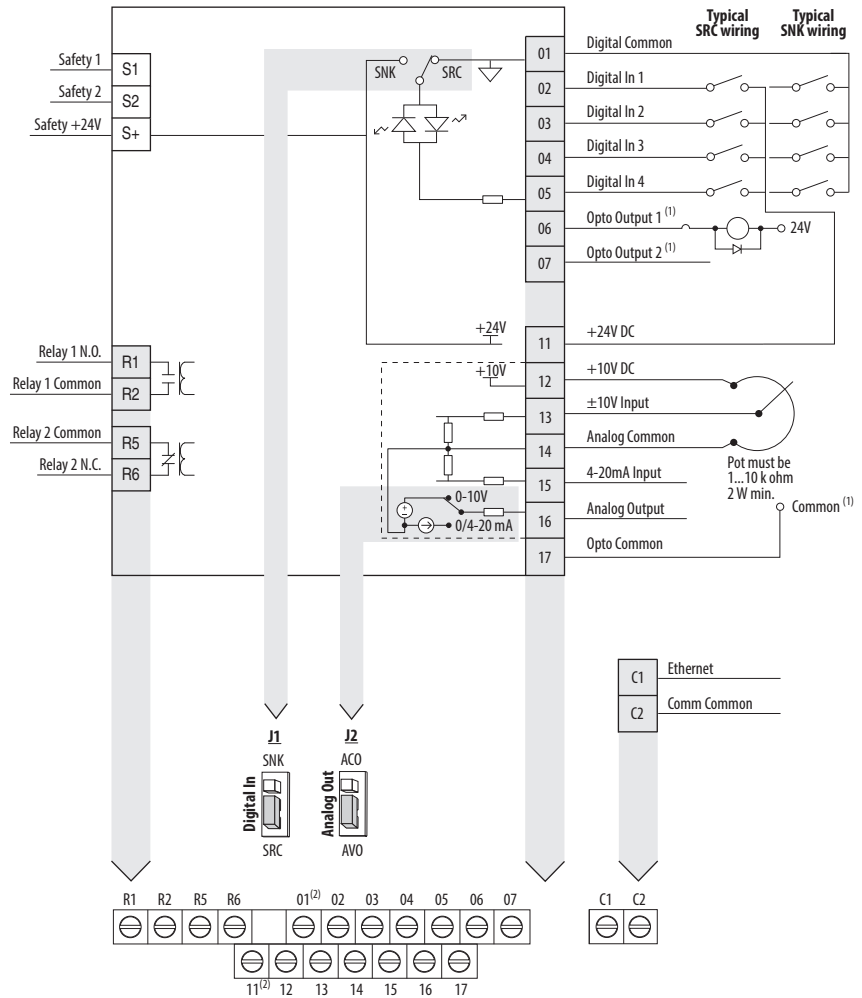

- (1) When using an opto output with an inductive load such as a relay, install a recovery diode parallel to the relay as shown, to help prevent damage to the output.
- (2) Do not short across Terminals 01 and 11.

### Control I/O Terminal Designations

No.	Signal	Description
R1	Relay 1 N.O.	These are the Normally Open (N.O.), Common, and Normally Closed (N.C.) contacts for the programmable relay output. Resistive: 1.0 A @ 30V DC/ 0.2 A @ 125V AC/ 0.1 A @ 230V AC Inductive: 0.5 A @ 30V DC/0.1 A @ 125V AC/ 0.1 A @ 230V AC Rated minimum current is 5 mA or less @ 24V DC.
R2	Relay 1 Common	
R5	Relay 2 Common	
R6	Relay 2 N.C.	<b>Note:</b> These are general-purpose outputs and do not have the same functionality as system outputs when compared to chassis or remote I/O products. See the Logix 5000® Controllers General Instructions Reference Manual, publication <a href="#">1756-RM003</a> , for important information regarding execution conditions and action that is taken for the respective instructions used to control the digital outputs on the drive.
01	Digital Common	The return for digital I/O. It is electrically isolated (along with the digital I/O) from the rest of the drive, except for the communications port.



Control I/O Terminal Designations (Continued)

No.	Signal	Description	
02	Digital In 1	Configurable to Home, Registration 1, Drive Enable, Positive Overtravel, and Negative Overtravel. If programmed as unassigned, this becomes a general-purpose input.	Set the Digital In jumper (J1) as shown. 
03	Digital In 2	Configurable to Registration 2, Drive Enable, Positive Overtravel, and Negative Overtravel. If programmed as unassigned, this becomes a general-purpose input.	
04	Digital In 3	Configurable to Drive Enable, Positive Overtravel, and Negative Overtravel. If programmed as unassigned, this becomes a general-purpose input.	
05	Digital In 4	Configurable to Drive Enable, Positive Overtravel, and Negative Overtravel. If programmed as unassigned, this becomes a general-purpose input.	
06	Opto Output 1	Programmable digital output.	<b>Note:</b> These are general-purpose outputs and do not have the same functionality as system outputs when compared to chassis or remote I/O products. See the Logix 5000 Controllers General Instructions Reference Manual, publication <a href="#">1756-RM003</a> , for important information regarding execution conditions and action that is taken for the respective instructions used to control the digital outputs on the drive.
07	Opto Output 2		
C1	Ethernet	This terminal is tied to the Ethernet port shield. Tie this terminal to a clean ground in order to improve noise immunity when using external communication peripherals.	
C2	Comm Common	This is the signal common for the communication signals.	
S1	Safety 1	Safety input 1	
S2	Safety 2	Safety input 2	
S+	Safety +24V	+24V supply for safety circuit. This is internally tied to the +24V DC source (Pin-11).	
11	+24V DC	+24V DC (+/-10%) supply for digital inputs. It is rated to supply at least 100 mA and will use Digital Common as the return. It will also be short-circuit protected (not damaged if tied to a Common or GND), for a short duration, and will not be damaged if connected to the +24V DC source of a different drive.	
12	+10V DC	+10V DC (-0% / +6%) supply for potentiometer or 0-10V input. It is rated to supply at least 15 mA and will use Analog Common as the return. It will also be short-circuit protected (not damaged if tied to a Common or GND) and will not be damaged if connected to the +10V DC source of a different drive.	
13	±10V In	±10V bipolar analog input optically isolated from the drive to avoid ground loops. This input has approximately 100K Ω input impedance. If a remote potentiometer is used with this input the maximum pot impedance is 10K Ω and the minimum impedance and the maximum is still 10K Ω. The A/D resolution will be 10-bit or better. The drive will not be damaged if up to ±27V DC or Voltage surge up to 1 kV is applied to this port. The input bandwidth shall be about 100 Hz.	
14	Analog Common	This is the return for the analog I/O. It is electrically isolated (along with the analog I/O) from the rest of the drive.	
15	4-20mA In	4-20 mA analog input optically isolated from the drive to allow daisy chain configurations and to avoid ground loops. The input impedance for the 4-20 mA analog input is approximately 250 Ω. The A/D resolution will be 10-bit or better.	
16	Analog Output	Configurable to a 0-20 mA or 0-10V analog output signal. Set the Analog Out jumper (J2) as shown, then set the ACO/AVO attribute. See <a href="#">Setting the ACO/AVO Attribute on page 162</a> for instructions.	
17	Opto Common	The emitters of the Optocoupler Outputs (1 and 2) are tied together at Optocoupler Common. They are therefore electrically isolated from the rest of the drive.	

**Tag Attributes in Logix Designer for Inputs and Outputs**

No.	Signal	Tag Attribute
<b>Analog Input</b>		
13	±10V In	<axis tag>.AnalogInput1
15	4-20mA In	<axis tag>.AnalogInput2
<b>Analog Output</b>		
16	Analog Output	<axis tag>.AnalogOutput1
<b>Digital Input</b>		
02	Digital In 1	<axis tag>.DigitalInput0
03	Digital In 2	<axis tag>.DigitalInput1
04	Digital In 3	<axis tag>.DigitalInput2
05	Digital In 4	<axis tag>.DigitalInput3
<b>Digital Output (1)</b>		
06	Opto Output 1	<axis tag>.DigitalOutput0
07	Opto Output 2	<axis tag>.DigitalOutput1
R1	Relay 1 N.O.	<axis tag>.DigitalOutput2
R6	Relay 2 N.C.	<axis tag>.DigitalOutput3

(1) These are general-purpose outputs and do not have the same functionality as system outputs when compared to chassis or remote I/O products. See the Logix 5000 Controllers General Instructions Reference Manual, publication [1756-RM003](#), for important information regarding execution conditions and action that is taken for the respective instructions used to control the digital outputs on the drive.

## CE Conformity

Compliance with the Low Voltage Directive and Electromagnetic Compatibility Directive has been demonstrated using harmonized European Norm (EN) standards that are published in the Official Journal of the European Communities. PowerFlex 520-series drives comply with the EN standards that are listed below when installed according to the installation instructions in this manual.

Product certifications and Declarations of Conformity (DoC) are available online at [rok.auto/certifications](http://rok.auto/certifications).

### Low Voltage Directive (2014/35/EU)

- EN 61800-5-1 Adjustable speed electrical power drive systems – Part 5-1: Safety requirements – Electrical, thermal, and energy.

### Pollution Degree Ratings According to EN 61800-5-1

Pollution Degree	Description
1	No pollution or only dry, non-conductive pollution occurs. The pollution has no influence.
2	Normally, only non-conductive pollution occurs. Occasionally, however, a temporary conductivity caused by condensation is to be expected, when the drive is out of operation.

### EMC Directive (2014/30/EU)

- EN 61800-3 – Adjustable speed electrical power drive systems - Part 3: EMC requirements and specific test methods.

### Machinery Directive (2006/42/EC)

- EN ISO 13849-1 – Safety of machinery – safety-related parts of control systems -Part 1: General principles for design.
- EN 61800-5-2 – Adjustable speed electrical power drive systems - Part 5-2: Safety requirement – Functional.
- EN 62061 – Safety of machinery – Functional safety of safety-related electrical, electronic, and programmable electronic control systems.

- EN 60204-1 – Safety of machinery – Electrical equipment of machines - Part 1: General requirements.
- EN 61508 Part 1-7 Functional safety of electrical/electronic/programmable electronic safety-related systems – Parts 1-7.

### **ATEX Directive (2014/34/EU)**

- EN 50495 – Safety devices that are required for the safe functioning of equipment with respect to explosion risks.

## **UKCA Conformity**

Compliance with application Statutory Regulations has been demonstrated using harmonized standards published in the UK list of Designated standards. PowerFlex 520-series drives comply with the EN standards listed below when installed according to the installation instructions in this manual.

UK Declarations of Conformity are available online at [rok.auto/certifications](http://rok.auto/certifications).

### **Electrical Equipment (Safety) Regulations (2016 No. 1101)**

- EN 61800-5-1 Adjustable speed electrical power drive systems – Part 5-1: Safety requirements – Electrical, thermal, and energy.

#### **Pollution Degree Ratings According to EN 61800-5-1**

<b>Pollution Degree</b>	<b>Description</b>
1	No pollution or only dry, non-conductive pollution occurs. The pollution has no influence.
2	Normally, only non-conductive pollution occurs. Occasionally, however, a temporary conductivity that is caused by condensation is to be expected, when the drive is out of operation.

### **Electromagnetic Compatibility Regulations (2016 No. 1091)**

- EN 61800-3 Adjustable speed electrical power drive systems – Part 3: EMC requirements and specific test methods.

### **Supply of Machinery (Safety) Regulations (2008 No. 1597)**

- EN ISO 13849-1 – Safety of machinery – Safety related parts of control systems -Part 1: General principles for design.
- EN 61800-5-2 – Adjustable speed electrical power drive systems – Part 5-2: Safety requirement – Functional.
- EN 62061 – Safety of machinery – Functional safety of safety-related electrical, electronic, and programmable electronic control systems.
- EN 60204-1 – Safety of machinery – Electrical equipment of machines – Part 1: General requirements.
- EN 61508 Part 1-7 Functional safety of electrical, electronic, and programmable electronic safety-related systems – Part 1-7.

### **Equipment and Protective Systems Intended for Use in Potentially Explosive Atmospheres Regulations (2016 No. 1107)**

- EN 50495 – Safety devices required for the safe functioning of equipment with respect to explosion risks.

## General Considerations

- For CE and UK compliance, drives must satisfy installation requirements that are related to both EN 61800-5-1 and EN 61800-3 provided in this document.
- PowerFlex 520-series drives must be installed in a pollution degree 1 or 2 environment to be compliant with the CE LV Directive and UK LV Regulations. See [Pollution Degree Ratings According to EN 61800-5-1 on page 37](#) for descriptions of each pollution degree rating.
- PowerFlex 520-series drives comply with the EMC requirements of EN 61800-3 when installed according to good EMC practices and the instructions that are provided in this document. However, many factors can influence the EMC compliance of an entire machine or installation, and compliance of the drive itself does not ensure compliance of all applications.
- PowerFlex 520-series drives are not intended to be used on public low-voltage networks that supply domestic premises. Without additional mitigation, radio frequency interference is expected if used on such a network. The installer is responsible for taking measures such as a supplementary line filter and enclosure (see [Connections and Grounding on page 41](#)) to prevent interference, in addition to the installation requirements of this document.



**ATTENTION:** NEMA/UL Open Type drives must either be installed in a supplementary enclosure or equipped with a “NEMA Type 1 Kit” to be CE and UK compliant with respect to protection against electrical shock.

- PowerFlex 520-series drives generate harmonic current emissions on the AC supply system. When operated on a public low-voltage network it is the responsibility of the installer or user to verify that applicable requirements of the distribution network operator have been met. Consultation with the network operator and Rockwell Automation may be necessary.
- If the optional NEMA 1 kit is not installed, the drive must be installed in an enclosure with side openings less than 12.5 mm (0.5 in.) and top openings less than 1.0 mm (0.04 in.) to maintain compliance with the LV Directive and UK LV Regulations.
- The motor cable should be kept as short as possible to avoid electromagnetic emission and capacitive currents.
- Use of line filters in ungrounded systems is not recommended.
- In CE and UK installations, input power must be a Balanced wye with Center Ground configuration for EMC compliance.
- If the DC Bus terminals or the Dynamic Brake terminals are used, the drive must be installed in an enclosure and fuses must be used for input protection. The ventilated enclosure needs to be IP 20 rating or higher and at least 1.5x size larger than the drive.

### *Installation Requirements Related to EN 61800-5-1 and the Low Voltage Directive/UK LV Regulations*

- 600V PowerFlex 520-series drives can only be used on a “center grounded” supply system for altitudes up to and including 2000 m (6562 ft).
- When used at altitudes above 2000 m (6562 ft) up to a maximum of 4800 m (15,748 ft), PowerFlex 520-series drives of voltage classes up to 480V may not be powered from a “corner-earthed” supply system to maintain compliance with the CE LV Directive and UK LV Regulations. See [Derating Guidelines for High Altitude on page 16](#).

- PowerFlex 520-series drives produce leakage current in the protective earthing conductor, which exceeds 3.5 mA AC and/or 10 mA DC. The minimum size of the protective earthing (grounding) conductor that is used in the application must comply with local safety regulations for high protective earthing conductor current equipment.



**ATTENTION:** PowerFlex 520-series drives produce DC current in the protective earthing conductor which may reduce the ability of RCD's (residual current-operated protective devices) or RCM's (residual current-operated monitoring devices) of type A or AC to provide protection for other equipment in the installation. Where an RCD or RCM is used for protection in case of direct or indirect contact, only an RCD or RCM of Type B is allowed on the supply side of this product.

#### *Installation Requirements Related to EN 61800-3 and the EMC Directive and UK EMC Regulations*

- The drive must be earthed (grounded) as described in [Connections and Grounding on page 41](#). See [General Grounding Requirements on page 18](#) for additional grounding recommendations.
- Output power wiring to the motor must employ cables with a braided shield providing 75% or greater coverage, or the cables must be housed in metal conduit, or equivalent shield must be provided. Continuous shielding must be provided from the drive enclosure to the motor enclosure. Both ends of the motor cable shield (or conduit) must terminate with a low-impedance connection to earth.  
Drive Frames A...E: At the drive end of the motor, either
  - a. The cable shield must be clamped to a properly installed “EMC Plate” for the drive, kit number 25-EMC1-Fx.  
or
  - b. The cable shield or conduit must terminate in a shielded connector that is installed in an EMC plate, conduit box, or similar.
- At the motor end, the motor cable shield or conduit must terminate in a shielded connector, which must be properly installed in an earthed motor wiring box that is attached to the motor. The motor wiring box cover must be installed and earthed.
- All control (I/O) and signal wiring to the drive must use cable with a braided shield providing 75% or greater coverage, or the cables must be housed in metal conduit, or equivalent shielding must be provided. When shielded cable is used, the cable shield should be terminated with a low impedance connection to earth at only one end of the cable, preferably the end where the receiver is located. When the cable shield is terminated at the drive end, it may be terminated either by using a shielded connector in conjunction with a conduit plate or conduit box, or the shield may be clamped to an “EMC plate.”
- Motor cabling must be separated from control and signal wiring wherever possible.
- Maximum motor cable length must not exceed the maximum length that is indicated in [Table 3](#) for compliance with radio frequency emission limits for the specific standard and installation environment.

Connections and Grounding

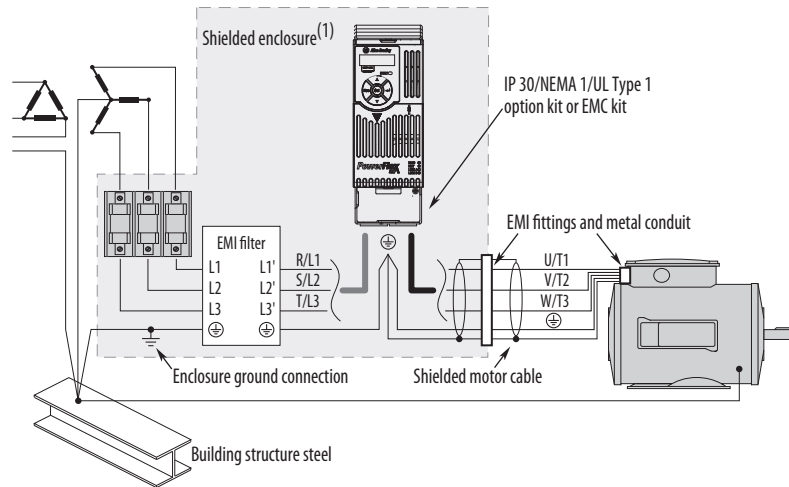

(1) Some installations require a shielded enclosure. Keep wire length as short as possible between the enclosure entry point and the EMI filter.

Table 3 - PowerFlex 527 RF Emission Compliance and Installation Requirements

Filter Type	Standard/Limits		
	EN61800-3 Category C1 EN61000-6-3 CISPR11 Group 1 Class B	EN61800-3 Category C2 EN61000-6-4 CISPR11 Group 1 Class A (Input power ≤ 20 kVA)	EN61800-3 Category C3 (I ≤ 100 A) CISPR11 Group 1 Class A (Input power > 20 kVA)
Internal	-	10 m (33 ft)	20 m (66 ft)
External <sup>(1)</sup>	30 m (16 ft)	100 m (328 ft)	100 m (328 ft)

(1) See [Accessories and Dimensions on page 137](#) for more information on optional external filters.

Additional Installation Requirements

This section provides information on additional requirements for Class C1 and C2 installation, such as enclosures and EMC cores.

**IMPORTANT** EMC cores are included with:

- Drives that have an internal EMC filter (25x-xxxxN114)
- External EMC filter accessory kit (25-RFxxx)

**IMPORTANT** An enclosure, shielded input cable, and EMC cores are not required to meet Class C3 requirements.

Additional Installation Requirements

Frame Size	Class C1			Class C2		
	Enclosure	Conduit or Shielded Cable @ Input	EMC Cores Required (Included with product)	Enclosure	Conduit or Shielded Cable @ Input	EMC Cores Required (Included with product)
<b>100...120V AC (-15%, +10%) - 1-Phase Input with External EMC Filter, 0...120V 1-Phase Output</b>						
A	No	No	No	No	No	No
B	No	No	No	No	No	No
<b>200...240V AC (-15%, +10%) - 1-Phase Input with External EMC Filter, 0...230V 3-Phase Output</b>						
A	Yes	Yes	No	No	No	Input/Output
B	Yes	Yes	Output only	No	No	Input/Output
<b>200...240V AC (-15%, +10%) - 1-Phase Input with Internal EMC Filter, 0...230V 3-Phase Output<sup>(1)</sup></b>						
A	*	*	*	Yes	No	No
B	*	*	*	Yes	No	No

**Additional Installation Requirements (Continued)**

Frame Size	Class C1			Class C2		
	Enclosure	Conduit or Shielded Cable @ Input	EMC Cores Required (Included with product)	Enclosure	Conduit or Shielded Cable @ Input	EMC Cores Required (Included with product)
<b>200...240V AC (-15%, +10%) - 3-Phase Input with External EMC Filter, 0...230V 3-Phase Output</b>						
A	Yes	Yes	Output only	No	No	Input/Output
B	Yes	Yes	Output only	No	No	Input/Output
C	Yes	Yes	Output only	No	No	Input/Output
D	Yes	Yes	No	No	No	Input only
E	Yes	Yes	Output only	No	No	Input only
<b>380...480V AC (-15%, +10%) - 3-Phase Input with External EMC Filter, 0...460V 3-Phase Output</b>						
A	Yes	Yes	No	No	No	Input/Output
B	Yes	Yes	No	No	No	Input/Output
C	Yes	Yes	No	No	No	Input only
D	Yes	Yes	Output only	No	No	Input/Output
E	Yes	Yes	No	Yes	No	Input/Output
<b>380...480V AC (-15%, +10%) - 3-Phase Input with Internal EMC Filter, 0...460V 3-Phase Output<sup>(1)</sup></b>						
A	*	*	*	No	No	Input/Output
B	*	*	*	No	No	Input/Output
C	*	*	*	No	No	Input/Output
D	*	*	*	No	No	Input/Output
E	*	*	*	No	No	Input/Output
<b>525...600V AC (-15%, +10%) - 3-Phase Input with External EMC Filter, 0...575V 3-Phase Output</b>						
A	Yes	Yes	No	No	No	Input/Output
B	Yes	Yes	No	No	No	Input/Output
C	Yes	Yes	No	No	No	Input/Output
D	Yes	Yes	No	No	No	Input/Output
E	Yes	Yes	No	Yes	No	No

(1) An (\*) indicates that EMC requirements are not met.

Recommended Placement of EMC Cores with Optional EMC Plate

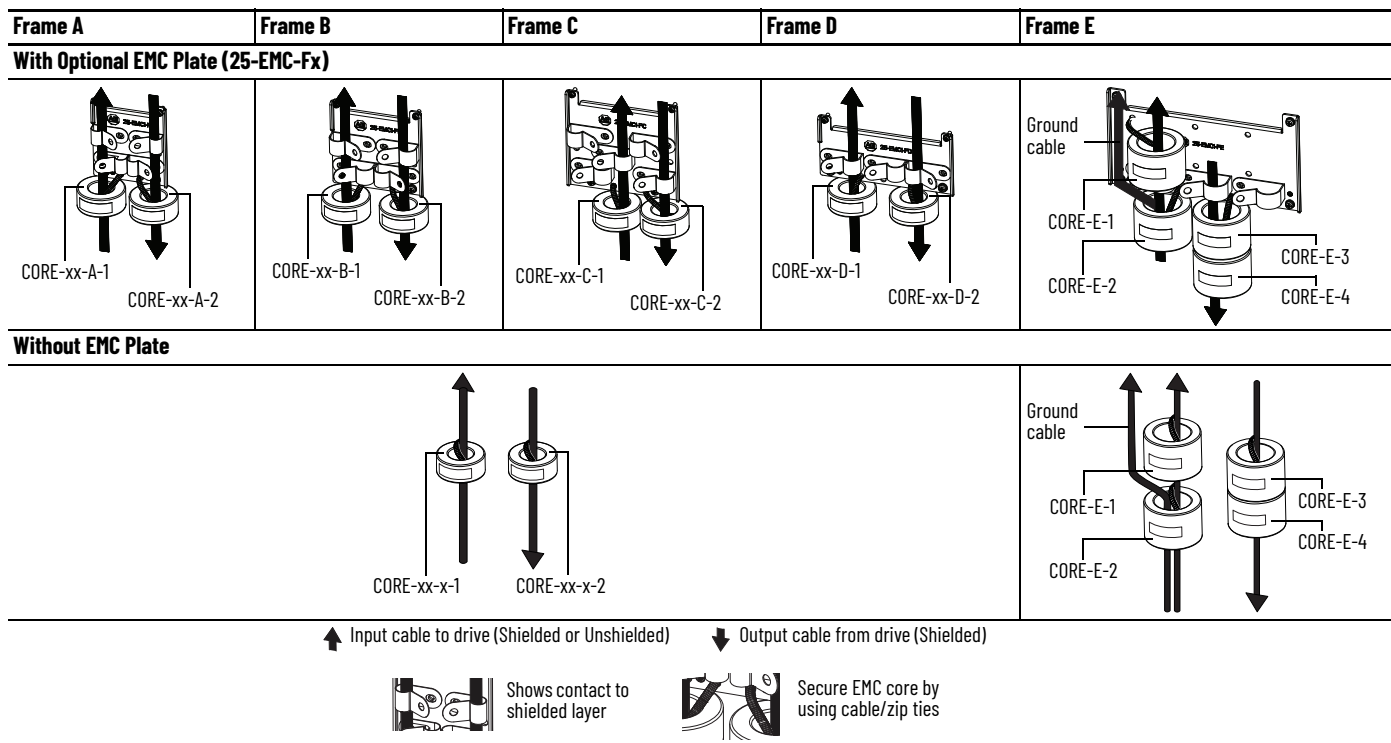

**IMPORTANT** The ground cable/shield for both input and output must pass through the EMC core(s), except for the following:

- Frame E drives with internal filters where the grounded input cable must not pass through EMC CORE-E-1.
- 600V drives with external filters where the grounded output cable must not pass through the EMC core(s).

Recommended Placement of EMC Cores Relative to External Filter

All Frame Sizes

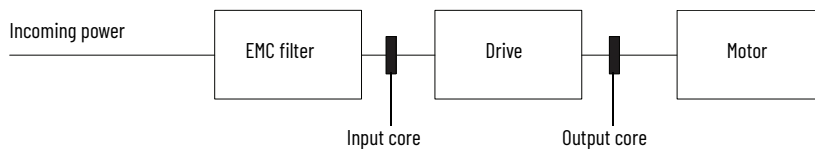



**Notes:**

## Start Up

This chapter describes how to start up the PowerFlex 527 drive.

Topic	Page
Prepare for Drive Startup	45
Understanding the PowerFlex 527 Display and Indicators	46
Drive Programming Tools	51
Language Support	52
Using the Ethernet Port	52

**IMPORTANT** Read [General Precautions on page 10](#) before proceeding.



**ATTENTION:** Power must be applied to the drive to perform the following startup procedures. Some of the voltages present are at incoming line potential. To avoid electric shock hazard or damage to equipment, only qualified service personnel should perform the following procedure. Thoroughly read and understand the procedure before beginning. If an event does not occur while performing this procedure, **Do Not Proceed. Remove All Power** including user supplied control voltages. User supplied voltages may exist even when main AC power is not applied to the drive. Correct the malfunction before continuing.

### Prepare for Drive Startup

Before starting up the drive, it is recommended to perform the startup tasks described below to achieve a smooth startup and drive operation. Verify that the drive is not powered (check that DC Bus voltage is less than 50V DC) before proceeding with the startup task list.

#### Drive Startup Task List

1. Disconnect and lock out power to the machine.
2. Verify that AC line power at the disconnect device is within the rated value of the drive.
3. If replacing a drive, verify the current catalog number of the drive. Verify all options installed on the drive.
4. Verify that any digital control power is 24 volts.
5. Inspect grounding, wiring, connections, and environmental compatibility.
6. Verify that the Sink (SNK)/Source (SRC) jumper is set to match your control wiring scheme. See the [PowerFlex 527 Control I/O Wiring Block Diagram on page 35](#) for location.
7. Wire I/O as required for the application.
8. Wire the power input and output terminals.
9. Confirm that all inputs are connected to the correct terminals and are secure.

10. Collect and record motor nameplate and encoder or feedback device information. Verify motor connections.
  - Is the motor uncoupled?
  - What direction will the motor need to turn for the application?
11. Verify the input voltage to the drive. Verify if the drive is on a grounded system. Verify that the MOV jumpers are in the correct position. See [AC Supply Source Considerations on page 17](#) for more information.
12. Apply AC power to the drive.
  - You need to establish a connection with a Logix controller and verify that the drive is enabled using a Logix motion instruction (for example MSO command) and no “START INHIBIT” condition exists. See [Configuring the PowerFlex 527 Drive with Integrated Motion on page 53](#) for instructions.
  - Verify that the drive is receiving start and stop commands correctly.
  - Verify that input currents are balanced.
  - Verify that motor currents are balanced.

### Start, Stop, Direction, and Speed Control

Start, Stop, Direction, and Speed Control are done using Logix motion instructions (for example, Motion Drive Start (MDS)). See the Logix 5000 Motion Controllers Instructions Reference Manual, publication [MOTION-RM002](#) for more information.

## Understanding the PowerFlex 527 Display and Indicators

The PowerFlex 527 drive has four status indicators, a fault indicator, an LCD display, and a membrane keypad for navigation. The display is used to view information such as motor information, axis states, faults, and set the network configuration. The indicators are used to monitor the module and network status, and troubleshoot faults.

**PowerFlex 527 Drive LCD Display and Status Indicators**

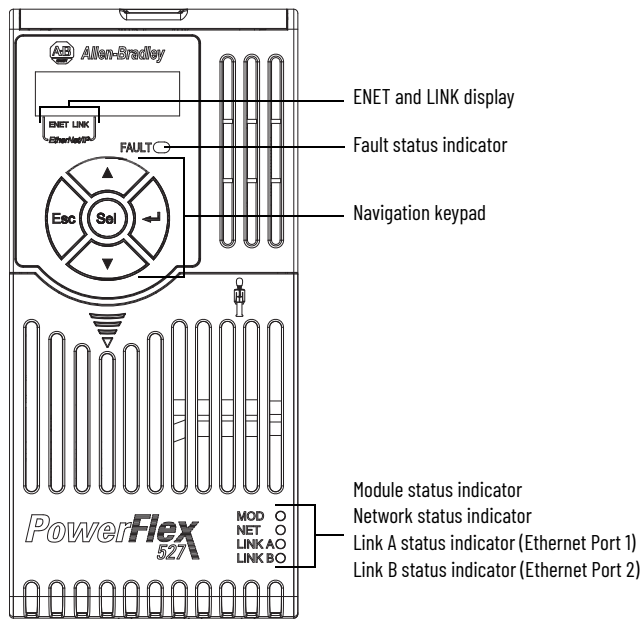

Display	Display State	Description
ENET	Off	Drive is not connected to the network.
	Steady	Drive is connected to the network.
LINK	Off	Drive has not established a controller connection.
	Steady	Drive is connected to the network and a controller connection has been established.

LED	LED State	Description
FAULT	Steady	Indicates that drive is faulted. See <a href="#">Fault Codes on page 116</a> for more information.

Key	Name	Description
	Up Arrow Down Arrow	Pressing either arrow moves the selection to the next (or previous) item. When changing values, pressing the Up arrow increments the highlighted value. Values rollover after reaching the end of the list.
	Escape	Press to go back. Pressing enough times results in the HOME screen.
	Select	Press to select a menu item.
	Enter	Press to confirm the selection and go to submenu items.

LED	LED State	Description
MOD	Steady Green	Drive is operational and no fault exists.
NET	Steady Green	Drive is online and has connections in the established state.
LINK A (Ethernet Port 1) LINK B (Ethernet Port 2)	Steady Green	Drive is connected to the network but not transmitting data.

For detailed descriptions of the Fault, MOD, NET, and LINK A/B status indicators, see [PowerFlex 527 Drive Status Indicators on page 120](#).

## Startup Sequence



On power-up, the drive will initialize and status information will scroll across the LCD display.



After initialization, the Device/Axis state will be shown on the LCD display. In this example, the current state is STANDBY.

## Device and Axis States

[Table 4](#) and [Table 5](#) list the possible Device and Axis states and their descriptions.

**Table 4 - Device States**

Device State	Description
STANDBY	The drive is waiting to receive configuration information from the controller.
CONNECTING	The drive is trying to establish communication with the EtherNet/IP™ controller.
CONFIGURING	The drive is receiving configuration information from the controller.
SYNCING	The drive is waiting for a successful Group Sync service.
CONN_TIMEOUT	The drive is trying to establish communication with the EtherNet/IP controller but the connection has timed out.
DUPLICATE_IP	The drive has detected another device on the network with the same IP address.
FWUPDATE	The drive is updating the firmware.

**Table 5 - Axis States**



Axis State	Description
INITIALIZING	The drive is initializing the motion connection.
PRECHARGE	The drive is ready for mains input power.
STOPPED	The drive is in the Stopped state and awaiting a motion command.
STARTING	The drive has received a motion command and is transitioning to the Running state from the Stopped state.
RUNNING	The drive is enabled and/or running.
TESTING	The drive is actively executing a test procedure, for example, a hookup test.
STOPPING	The drive is decelerating to a stop as the result of a disable.
ABORTING	The drive is decelerating to a stop as the result of a fault or an abort request.
MAJOR FAULTED	The drive is faulted due to an existing or past fault condition.
START INHIBITED	The drive has an active condition that inhibits it from being enabled.
SHUTDOWN	The drive has been shut down.

If a boot fault occurs during initialization, a fault number shows up on the screen with the format, “BFxxx”, where “BF” represents boot fault and “xxx” refers to the fault code. In this example, fault BFO03 is shown.



For a list of other types of possible faults, see [Fault Codes on page 116](#).

## Information Display

From the axis state screen, press Select  or the Down  arrow to access the following information menu:

Screen Option	Description	Example Display <sup>(1)</sup>
Version Info	Provides information on the hardware and software versions.	HW Ver 01.002 FW Ver 01.102
Device Info	Provides information on the drive type, network configuration, and IP address.	PowerFlex 527 Static IP 192.168.1.180 or PowerFlex 527 DHCP 192.168.1.180 <sup>(2)</sup>
Settings	Allows configuration of network settings, changing the display language, and resetting the drive.	See <a href="#">Network Configuration</a> for instructions on how to configure the IP address.

(1) The LCD only accommodates up to five characters. Text strings that are more than five characters are scrolled.

(2) If "0.0.0.0" is displayed and DHCP is enabled, it means that the IP address has not been assigned by the DHCP server. Check your network settings.

### Navigating the Settings Menu

Settings Menu Selections	Sub Menu Selections	Attributes	Default	Description	
Protected Mode <sup>(1)</sup>	Reset	ENABLED DISABLED	ENABLED	When Enabled (default), identity object resets are not possible when a controller connection is open.	
	Network Config	ENABLED DISABLED	ENABLED	When Enabled (default), network configuration changes are not possible when a controller connection is open.	
	Flash Update	ENABLED DISABLED	ENABLED	When Enabled (default), firmware updates are not possible when a controller connection is open.	
	Device Config	ENABLED DISABLED	ENABLED	When Enabled (default), only attribute writes are possible when a controller connection is open.	
Network	Static IP	IP address	192.168.1.180	Indicates current IP address.	
		Subnet mask	255.255.255.0	Indicates current subnet mask.	
		Gateway	192.168.1.1	Indicates current gateway.	
	DHCP	IP address	Automatically assigned by the DHCP server.		Indicates current IP address.
		Subnet mask			Indicates current subnet mask.
		Gateway			Indicates current gateway.
Web <sup>(1)</sup>	Enabled			Enables the web server.	
	->Disabled <sup>(2)</sup>			Disables the web server.	

(1) This setting is only available in PowerFlex 527 firmware revision 2.001 or later.

(2) An arrow (->) appears in front of the chosen attribute indicating that this attribute is currently configured. This is also the factory default setting.

## Network Configuration

Through the settings option, you can configure the drive IP address. There are two methods for configuring the drive IP address:

















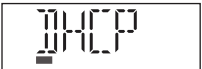









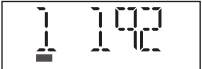

- **Static IP** – Use Static IP when you want to manually configure the IP address, subnet mask, and gateway addresses.
- **DHCP (Dynamic Host Configuration Protocol)** – Use DHCP when you want convenience and ease-of-use compared to Static IP. The IP address, subnet mask, and gateway addresses will be assigned automatically by the DHCP server.

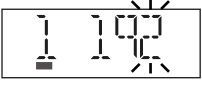
**IMPORTANT** Regardless of the method used to set the adapter IP address, each node on the EtherNet/IP network must have a unique IP address. To change an IP address, you must set the new value and then power cycle the drive.

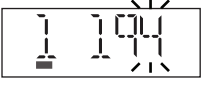
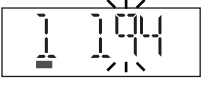

You can also use the Reset function, however all safety connections will have to be disabled before this option is available.

You must enter a valid IP address configuration. With firmware 1.008 or later, if an illegal IP address configuration exists upon power-up, for example, if the IP address and gateway address are identical, the drive faults and exhibits INIT FLT M22 - ILLEGAL ADDRESS on the display and the IP address configuration changes to DHCP.

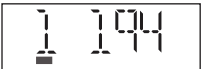
### Configuring Network Settings

Step	Keys	Example Display
1. On the Device/Axis state screen, press the Down arrow to go to the Settings menu.		
2. Press Enter to display the Network Settings screen.		
3. Press the Up or Down arrow to select either DHCP or Static IP, then press Enter.  If you choose DHCP, go to <a href="#">step 4</a> . If you choose Static IP, go to <a href="#">step 5</a> .	 or 	 or 
4. Press Enter to confirm DHCP as the network configuration option. Choosing DHCP automatically configures the IP settings for your drive.  This completes the network configuration for your drive.		
5. Choosing Static IP enables you to manually configure the IP address, subnet mask, and gateway address for your drive. Press the Up or Down arrow to scroll through the settings.	 or 	  
6. In this example, we will start by configuring the IP address. Select IP address, then press Enter to display the first octet of the IP address.		
7. Press the Up or Down arrow to scroll through the four octets of the IP address.	 or 	
8. Press Sel to edit an octet. The rightmost digit of the octet will flash.		
9. Press the Up or Down arrow to change the digit.  Press Sel to edit the digits on the left.	 or   	  
10. Press ESC to cancel a change and exit the edit mode. Or Press Enter to save a change and exit the edit mode.	 or 	 or 

## Configuring Network Settings (Continued)

Step	Keys	Example Display
11. Repeat <a href="#">step 7</a> to <a href="#">step 10</a> to edit the values of the other octets. After you have finished configuring the IP address. Press ESC to go back to the Static IP menu.		
12. Repeat <a href="#">step 5</a> to <a href="#">step 11</a> to configure the subnet mask and gateway address.		
13. Power cycle the drive to store the new IP settings.  This completes the network configuration for your drive.		

**IMPORTANT** You must cycle power to make network configuration changes persistent. An asterisk (\*) is shown next to the network configuration when viewing the Device Info screen option to signify that a change has been made but has not taken effect.

For example, after changing the network configuration from Static IP to DHCP, when viewing the Device Info screen option, an asterisk (\*) appears next to the text "DHCP" on the LCD display.

The change takes effect and the asterisk is removed after you cycle power to the drive.

Display configuration changes take effect immediately.



## Real-time Information Display

Once the drive is enabled and running and connected to a controller, the following information can be accessed through the LCD screen.

Real-time Information	Description	Example Display
Velocity Feedback	Displays the value of the velocity feedback in units/sec. See motion attribute 454.	VELOCITY FDBK 0.0
Motor Current	Displays the value of the motor current in % motor rated. See motion attribute 529.	MOTOR CURT 0.0
Motor Utilization	Displays the value of the motor utilization in %. See motion attribute 635.	MOTOR UTIL 0.0
DC Bus Voltage	Displays the value of the DC Bus voltage in VDC. See motion attribute 620.	DC BUS VLTG 0.0
Current Command	Displays the value of the torque current in % motor rated. See motion attribute 524.	CURRENT CMD 0.0
Output Current	Displays the value of Output Current in Amps RMS. See motion attribute 601.	OUTPUT CURT 0.0

**Note:** See Integrated Motion on the EtherNet/IP Network Reference Manual, publication [MOTION-RM003](#), for complete motion attribute description.

## Drive Programming Tools

Some features in the PowerFlex 527 drive are not supported by older configuration software tools. It is strongly recommended that customers using such tools migrate to Studio 5000 Logix Designer application (version 24 or later) with Add-on Profile (AOP) to enjoy a richer, full-featured configuration experience.



## Language Support

Language	Keypad/LCD Display	Logix Designer Application
English	Y	Y
French	Y	Y
Spanish	Y	Y
Italian	Y	Y
German	Y	Y
Japanese	-	Y
Portuguese	Y	Y
Simplified Chinese	-	Y
Korean	-	Y
Polish <sup>(1)</sup>	Y	-
Turkish <sup>(1)</sup>	Y	-
Czech <sup>(1)</sup>	Y	-

(1) Due to a limitation of the LCD display, some of the characters for Polish, Turkish, and Czech will be modified.

## Using the Ethernet Port

The PowerFlex 527 drive has dual embedded Ethernet ports that connect the drive to an EtherNet/IP network. This enables communication with a Logix based control system for drive control using CIP Motion commands. You can also upgrade the drive firmware or upload/download a configuration easily using the Studio 5000 Logix Designer application.

The EtherNet/IP network offers a full suite of control, configuration, and data collection services by layering the Common Industrial Protocol (CIP™) over the standard protocols used by the Internet (TCP/IP and UDP). EtherNet/IP uses TCP/IP for general messaging/information exchange services and UDP/IP for I/O messaging services for control applications.

Liner, Star, and Device Level Ring network topologies are supported by the PowerFlex 527 drive. Plus, the application of the CIP Safety™ protocol enables the simultaneous transmission of safety and standard control data and diagnostics information.

## Configuring the PowerFlex 527 Drive with Integrated Motion

This chapter describes procedures on how to configure Integrated Motion on the EtherNet/IP network control by using a PowerFlex 527 Drive.

Topic	Page
Configure the Drive	53
Configure the Logix Designer Application Project	54
Add a PowerFlex 527 Drive	58
Configure the PowerFlex 527 Drive	59
Apply Power to the PowerFlex 527 Drive	79
Test and Tune the Axes - Velocity and Position Control Modes	80



Before you begin, make sure that you know the catalog number for each drive component, the Logix module and/or controller used in your motion control application.

### Configure the Drive

You can include the drive in your Studio 5000 Logix Designer application by adding it to a configured EtherNet/IP module or controller and adding it under the I/O configuration tree. After setting the network configuration, you can view the drive status information in the Studio 5000 environment and use it in your Studio 5000 Logix Designer application.

### Set the Network Configuration

You can set the network configuration by using the LCD display and drive keypad.

1. When the LCD display is showing the Device/Axis state, use the keypad to navigate to SETTINGS -> NETWORK. Then choose either STATIC IP or DHCP.  
The default setting is STATIC IP.
2. If you chose STATIC IP, then you must configure the following settings:
  - IP address
  - Gateway
  - Subnet mask

If you chose DHCP, the three settings above are configured automatically by the DHCP server.

Settings are stored in nonvolatile memory. IP addressing can also be changed through the Module Configuration dialog box in RSLinx<sup>®</sup> software. Changes to the IP addressing take effect after power is cycled or reset. The drive is factory programmed to static IP address of 192.168.1.180.

See [Configuring Network Settings on page 50](#) for help on configuring the IP settings.

## Configure the Logix Designer Application Project

These procedures assume that you have wired your PowerFlex 527 drive system. In this example, the CompactLogix 5370 controller is used.

For help with using the Studio 5000 Logix Designer application (version 24 or later) application as it applies to configuring the ControlLogix or CompactLogix controllers, see [Additional Resources on page 8](#).

### Configure the Logix 5000 Controller

Follow these steps to configure the controller.

1. Apply power to your controller and open your Logix Designer application.



2. From the Create menu, choose New Project. The New Project dialog box appears.

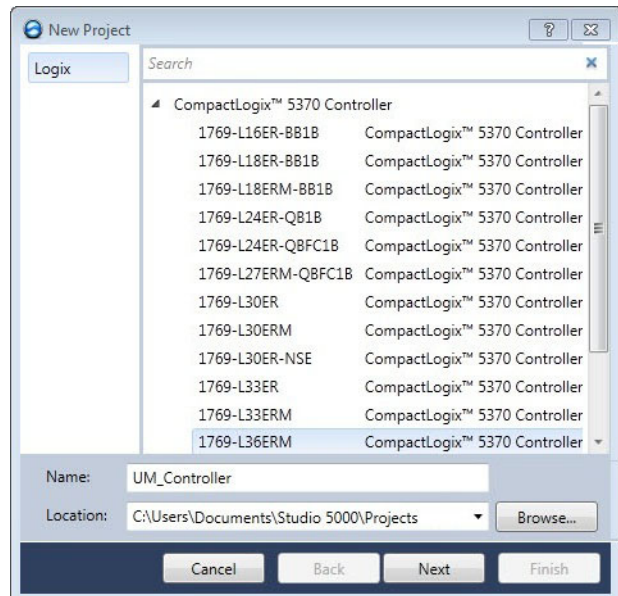
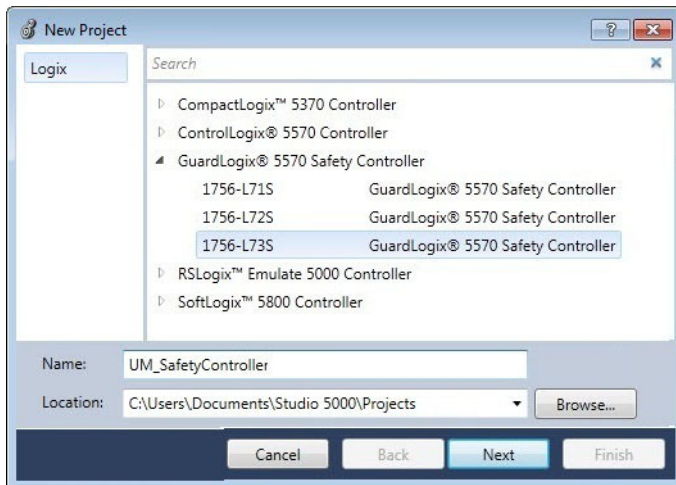

**IMPORTANT** If you are configuring a PowerFlex 527 drive for integrated safety in a safety application, you must use a GuardLogix safety controller.

If using a safety or non-safety ControlLogix controller, you must also use a 1756-EN2T, 1756-EN2TR, or 1756-EN3TR EtherNet/IP module. If using a CompactLogix 5370 controller, it has dual embedded EtherNet/IP ports.

In this example, the typical dialog boxes for 1756-L7xS GuardLogix 5570 safety controllers and CompactLogix 5370 controllers are shown.

Follow these steps to configure your Logix 5000 controller.

1. Expand the Logix 5000 controller family and select your controller.
2. Type the file name.
3. Click Next.

The New Project dialog box appears.

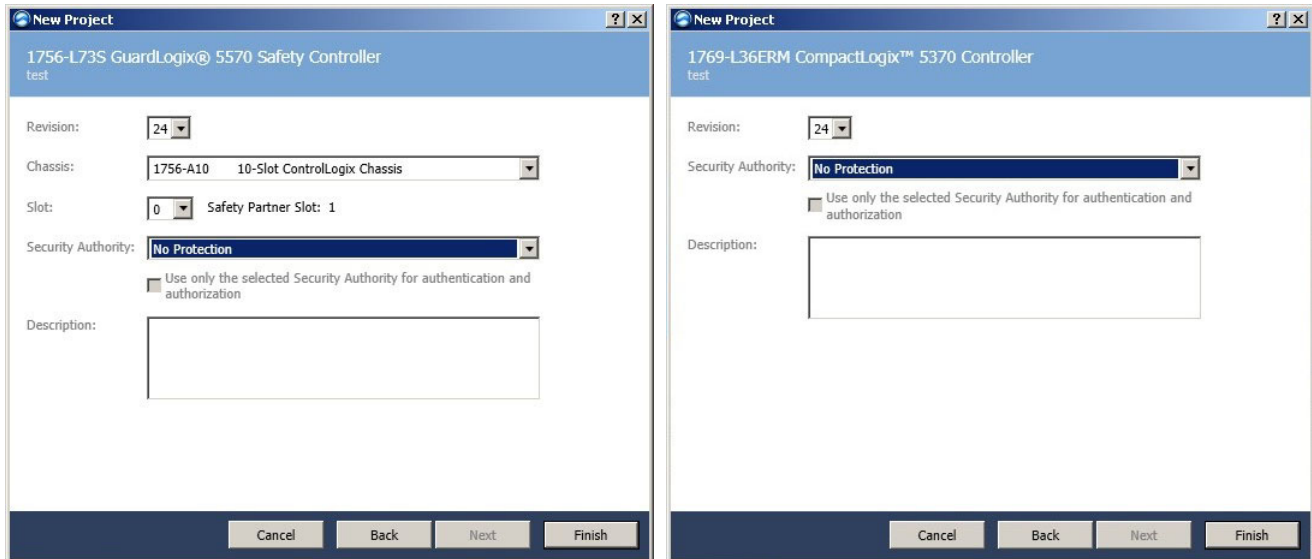

4. From the Revision pull-down menu, choose your software revision.
5. Click Finish.

The new controller appears in the Controller Organizer under the I/O Configuration folder.

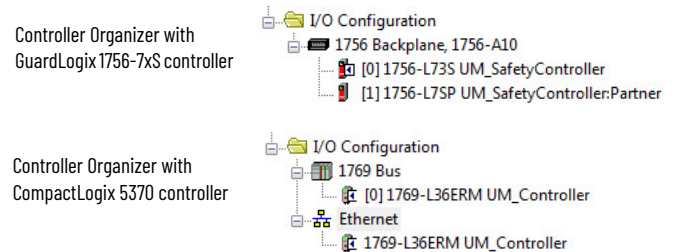

**IMPORTANT** If your project includes a ControlLogix or GuardLogix controller, you need to add an Ethernet communication module to your Bulletin 1756 chassis and configure it for use in your application.

- For ControlLogix or GuardLogix controllers, go to [step 6](#).
- For CompactLogix 5370 controllers, go to [step 13](#).

See the EtherNet/IP Network Configuration User Manual, publication, [ENET-UM001](#) for more information.

6. Right-click I/O Configuration in the Controller Organizer and choose New Module.

The Select Module Type dialog box appears.

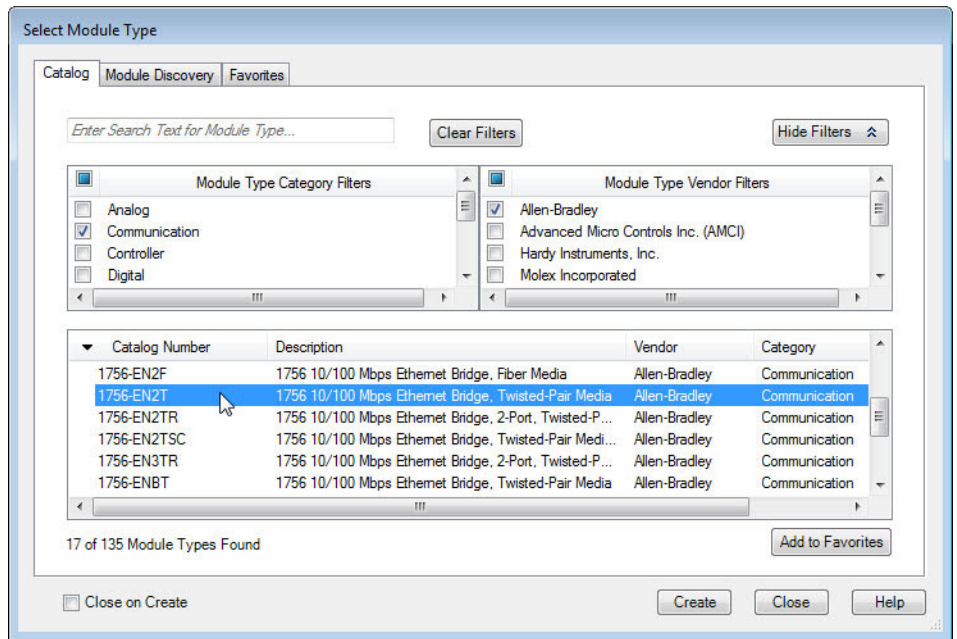

7. By using the filters, check Communication and Allen-Bradley, and select 1756-EN2T, 1756-EN2TR, or 1756-EN3TR as appropriate for your actual hardware configuration.  
In this example, the 1756-EN2T module is selected.
8. Click Create.  
The New Module dialog box appears.

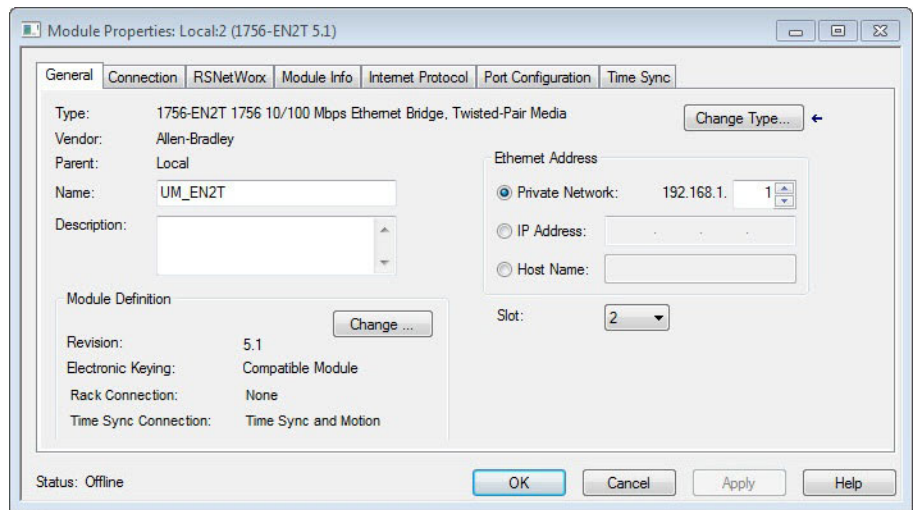

- a. Configure the new module.
- b. Type the module Name.
- c. Enter the Logix EtherNet/IP module slot (leftmost slot = 0).
- d. Select an Ethernet Address option.  
In this example, the Private Network address is selected.
- e. Enter the address of your EtherNet/IP module.  
In this example, the last octet of the address is 1.
- f. Click Change in the Module Definition area.

The Module Definition dialog box opens.

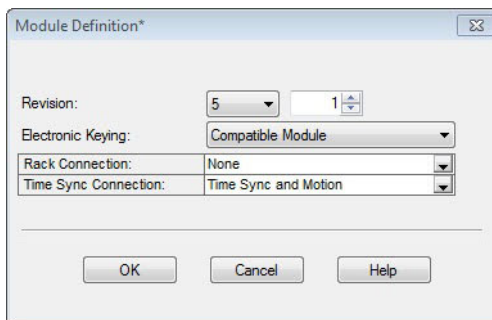

- From the Time Sync Connection pull-down menu, choose Time Sync and Motion.

**IMPORTANT** Time Sync functionality is what enables motion control on an Ethernet network. Without this setting, you won't be able to run your motion application.

- Click OK to close the Module Definition dialog box.
- Click Yes when prompted to confirm your module definition changes.

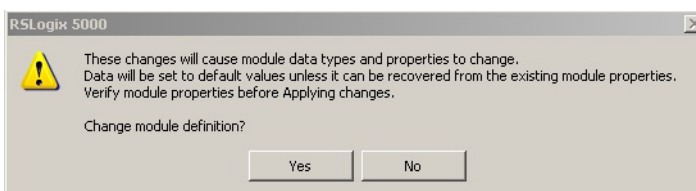

- Click OK to close the New Module dialog box.

Your new 1756-ENxT Ethernet module appears under the I/O configuration folder in the Controller Organizer.

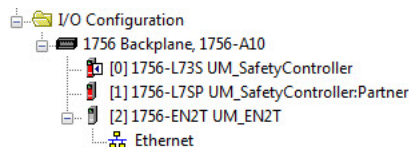

- From the Edit menu, choose Controller Properties. The Controller Properties dialog box appears.
- Click the Date/Time tab.

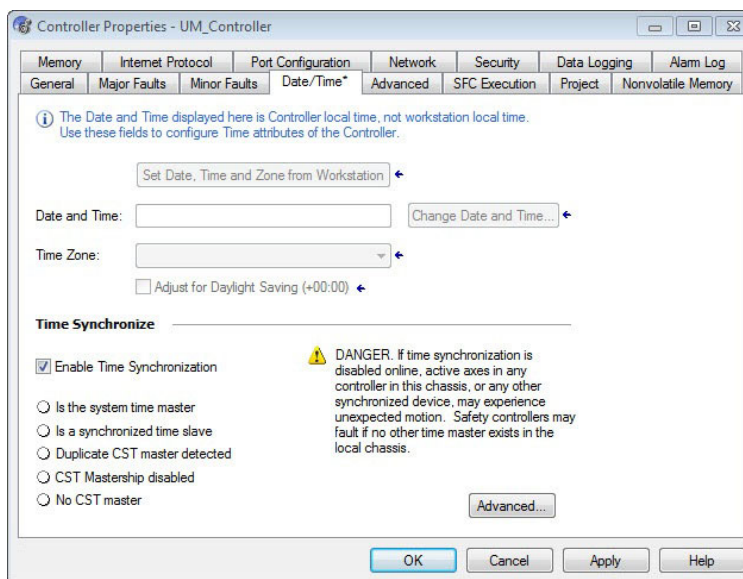

- Check Enable Time Synchronization.



The motion modules set their clocks to the module you assign as the Grandmaster.

**IMPORTANT** Check Enable Time Synchronization for all controllers that participate in CIP Sync™. The overall CIP Sync network automatically promotes a Grandmaster clock, unless the priority is set in the Advanced tab.

16. Click OK.

## Add a PowerFlex 527 Drive

Follow these instructions to add the PowerFlex 527 drive to your project.

1. Right-click the Ethernet network (node) and choose New Module...

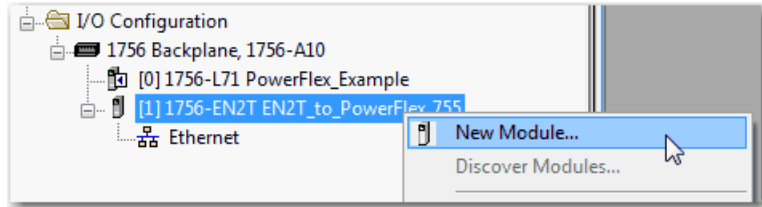

2. Clear the small 'select all' check boxes, Module Type Category and Vendor Filters.

Alternatively, you can simply type "527" into the search box and choose the drive.

3. In the Module Type Category Filters window, check Drive.

In the Module Type Vendors Filters window, check Allen-Bradley.

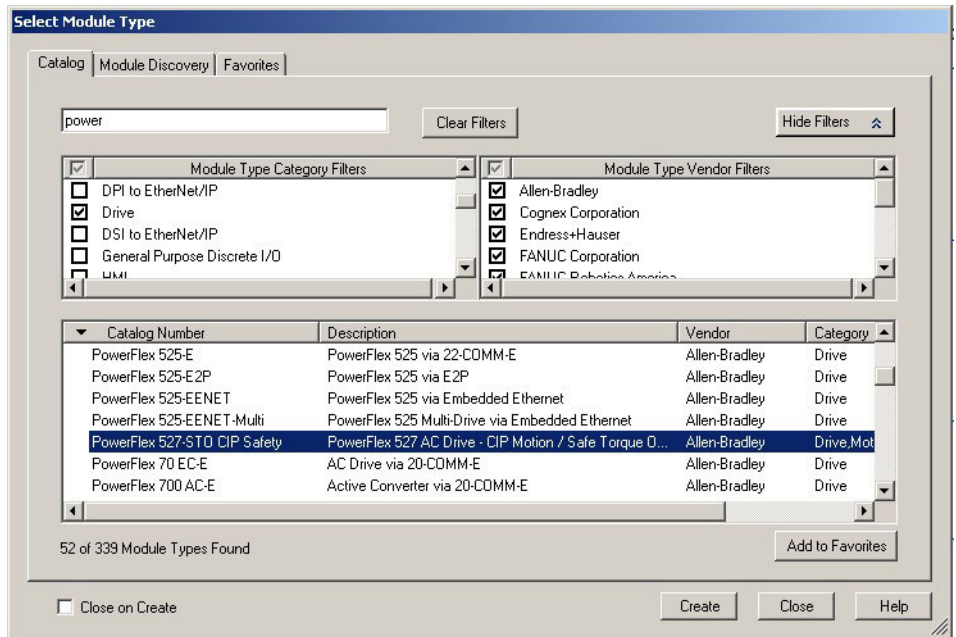

4. Choose the PowerFlex 527 drive and click Create.  
The Module Properties dialog box appears.

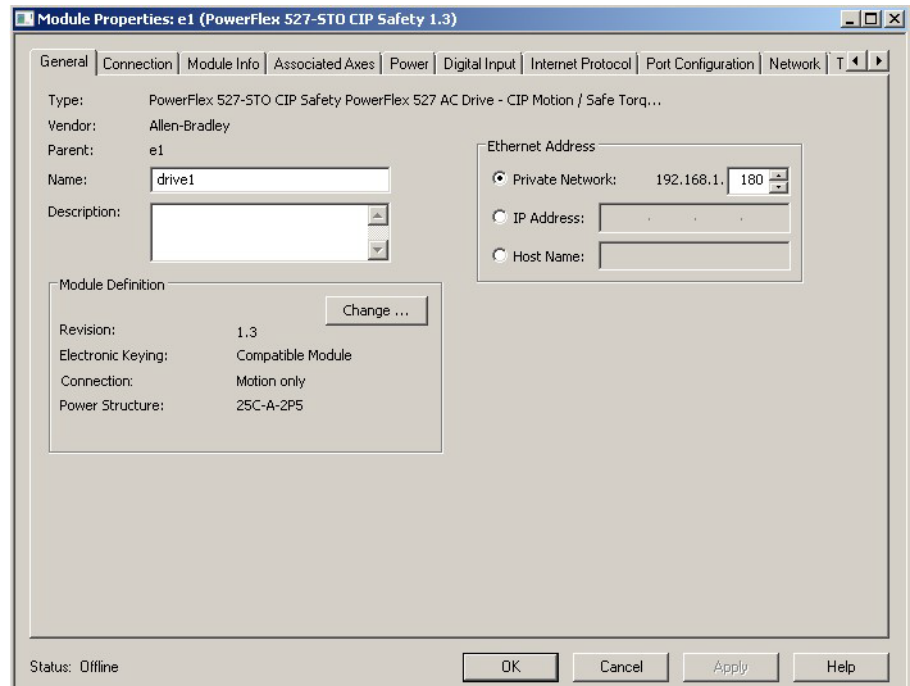

5. Configure the new drive.
  - a. Type the drive Name.
  - b. Type a Description, if desired.
  - c. Select an Ethernet Address option.  
In this example, the Private Network address is selected.
  - d. Enter the address of your PowerFlex 527 drive.  
In this example, the last octet of the address is 180.
6. Proceed to [Configure the PowerFlex 527 Drive](#) to continue configuring your drive.

## Configure the PowerFlex 527 Drive

After you have added a PowerFlex 527 drive to your project, you will need to configure the type of safety connection suitable for your application. See the following sections for instructions on configuring the drive for the different types of safety connections.

- [Configure Drive with Hardwired Safety Connections on page 60](#)
- [Configure Drive with Integrated Safety Connections on page 61](#)



Connection Mode	Controller Needed	Description
Motion only	ControlLogix 5570, GuardLogix 5570, CompactLogix 5370, ControlLogix 5580, CompactLogix 5380, or Compact GuardLogix 5370 <sup>(1)</sup>	<ul style="list-style-type: none"> <li>• Hard-wired Safe Torque Off (STO) connections are possible.</li> <li>• This controller manages Motion.</li> <li>• Another controller that has a Safety only connection to the drive manages Safety.</li> </ul>
Motion and Safety	GuardLogix 5570, GuardLogix 5580, Compact GuardLogix 5370 <sup>(1)</sup> , or Compact GuardLogix 5380	This controller manages Motion and Safety.
Safety only	GuardLogix 5570, GuardLogix 5580, Compact GuardLogix 5370, or Compact GuardLogix 5380	<ul style="list-style-type: none"> <li>• This controller manages Safety.</li> <li>• Another controller that has a Motion only connection to the drive manages Motion.</li> </ul>

(1) Catalog numbers containing the letter M.

**IMPORTANT** To configure PowerFlex 527 drives, you must use the Logix Designer application, version 24.00 or later.

### Configure Drive with Hardwired Safety Connections

Follow these steps to configure the PowerFlex 527 drives with hardwired safety.

1. Verify that you have done the steps in [Add a PowerFlex 527 Drive on page 58](#) before proceeding.
2. Under Module Definition, click Change.

The Module Definition dialog box appears.

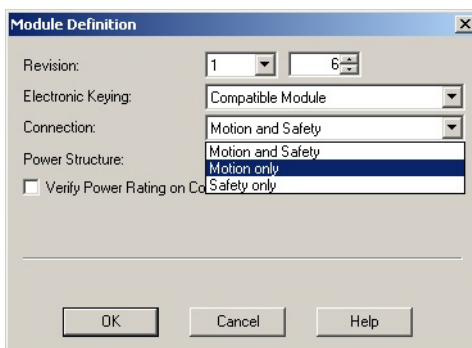

- a. From the Electronic Keying pull-down menu, choose an option.



**WARNING:** When using motion modules, the electronic keying must be either “Exact Match” or “Compatible Keying”. Never use “Disable Keying” with motion modules.

- b. From the Connection pull-down menu, choose the Connection mode for your motion application.

In this example, choose Motion only.



When ‘Safety’ appears in the Connection mode, integrated safety is implied.

- c. From the Power Structure pull-down menu, choose the catalog number that matches your power structure.

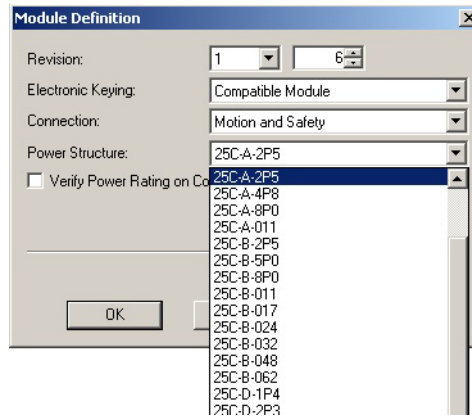

- d. Check the Verify Power Rating on Connection checkbox to confirm that the proper power structure that is defined in the profile is the same as the connected drive. If the two do not match, a connection error occurs, which indicates a power mismatch.

Verify Power Rating on Connection is checked by default. It is enabled in offline mode.

3. Click OK to close the Module Definition dialog box.
4. Click OK to close the Module Properties dialog box.

Your PowerFlex 527 drive appears in the Controller Organizer under the Ethernet controller in the I/O configuration folder.

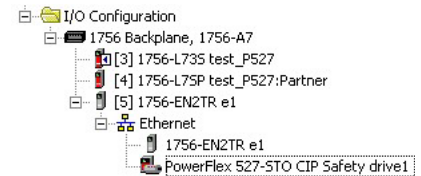

5. Proceed to [Continue Drive Configuration on page 64](#) to continue configuring your drive.

## Configure Drive with Integrated Safety Connections

Follow these steps to configure PowerFlex 527 drives with integrated safety.

1. Verify that you have done the steps in [Add a PowerFlex 527 Drive on page 58](#) before proceeding.
2. Under Module Definition, click Change.

The Module Definition dialog box appears.

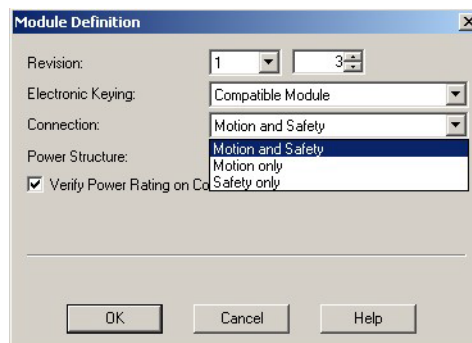

- a. From the Electronic Keying pull-down menu, choose an option.



**WARNING:** When using motion modules, the electronic keying must be either “Exact Match” or “Compatible Keying”. Never use “Disable Keying” with motion modules.

- b. From the Connection pull-down menu, choose the Connection mode for your motion application.

In this example, choose Motion and Safety.



When ‘Safety’ appears in the Connection mode, integrated safety is implied.

The Safety Network Number (SNN) field populates automatically when the Connection mode includes an integrated Motion and Safety or Safety-only connection. For a detailed explanation of the safety network number, see the GuardLogix 5570 and Compact GuardLogix 5370 Reference Manual, publication [1756-RM099](#).

- c. From the Power Structure pull-down menu, choose the catalog number that matches your power structure.

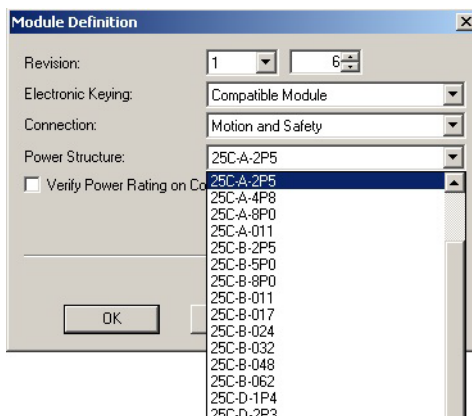

- d. Check the Verify Power Rating on Connection check box to confirm that the proper power structure that is defined in the profile is the same as the connected drive. If the two do not match, a connection error occurs, which indicates a power mismatch.

Verify Power Rating on Connection is checked by default. It is enabled in offline mode.

- 3. Click OK to close the Module Definition dialog box.

## 4. Click the Safety tab.

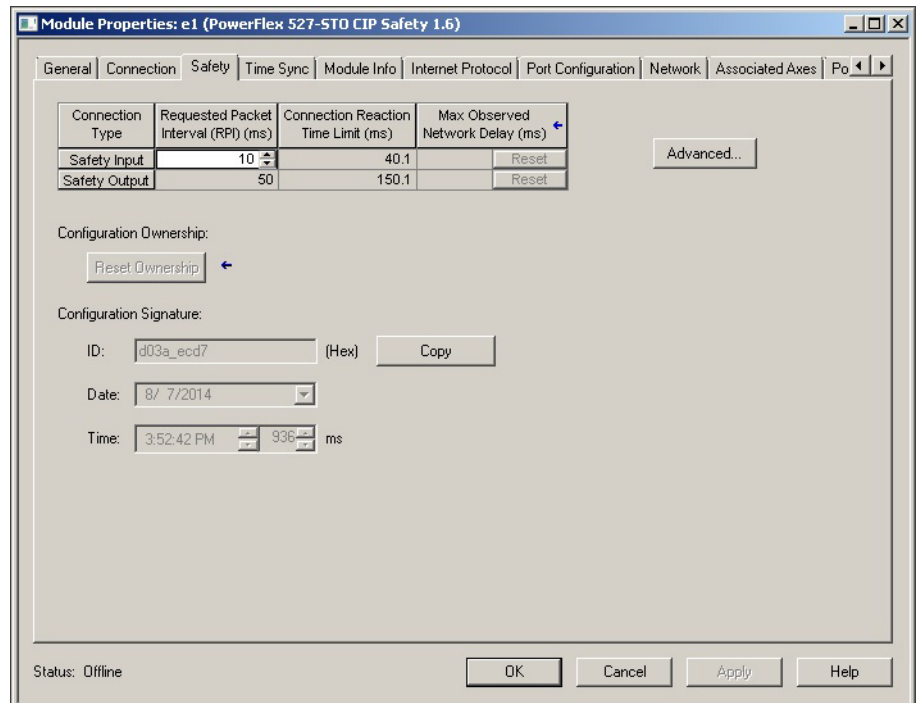

The connection between the controller and the PowerFlex 527 drive is based on the following:

- Drive catalog number must be PowerFlex 527 (integrated)
- Drive Safety Network Number (SNN)
- GuardLogix slot number
- GuardLogix safety network number
- Path from the GuardLogix controller to the PowerFlex 527 drive
- Configuration signature

If any differences are detected, the connection between the GuardLogix controller and the PowerFlex 527 drive is lost, and the yellow icon appears in the controller project tree after you download the program.

## 5. Click Advanced.

The Advanced Connection Reaction Time Limit Configuration dialog box appears.

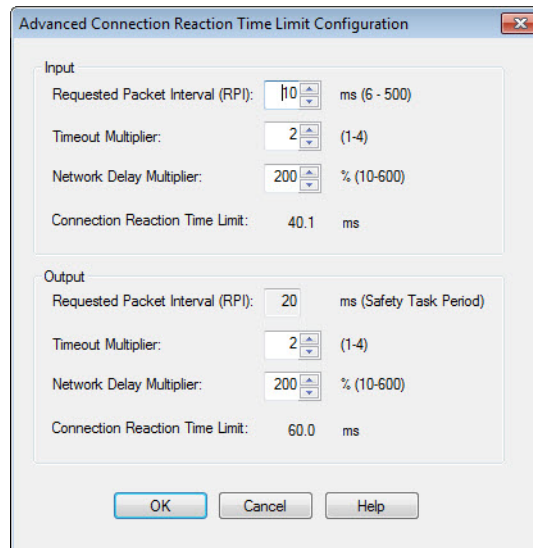

Analyze each safety channel to determine the appropriate settings. The smallest Input RPI allowed is 6 ms. Selecting small RPI values consumes network bandwidth and can cause nuisance trips because other devices cannot get access to the network.

For more information about the Advanced Connection Reaction Time Limit Configuration, see the GuardLogix 5570 Controllers User Manual, publication [1756-UM022](#).

6. Click OK to close the Advanced Connection Reaction Time Limit Configuration dialog box.
7. Click OK to close the Module Properties dialog box.

Your PowerFlex 527 drive appears in the Controller Organizer under the Ethernet controller in the I/O Configuration folder.

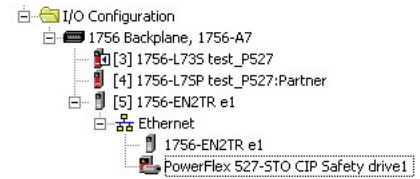

8. Proceed to [Continue Drive Configuration](#) to continue configuring your drive.

### Continue Drive Configuration

After you have established your PowerFlex 527 drive in the Logix Designer application, the remaining configuration steps are the same regardless of the drive catalog number.

1. Right-click the PowerFlex 527 drive you created and choose Properties. The Module Properties dialog box appears.

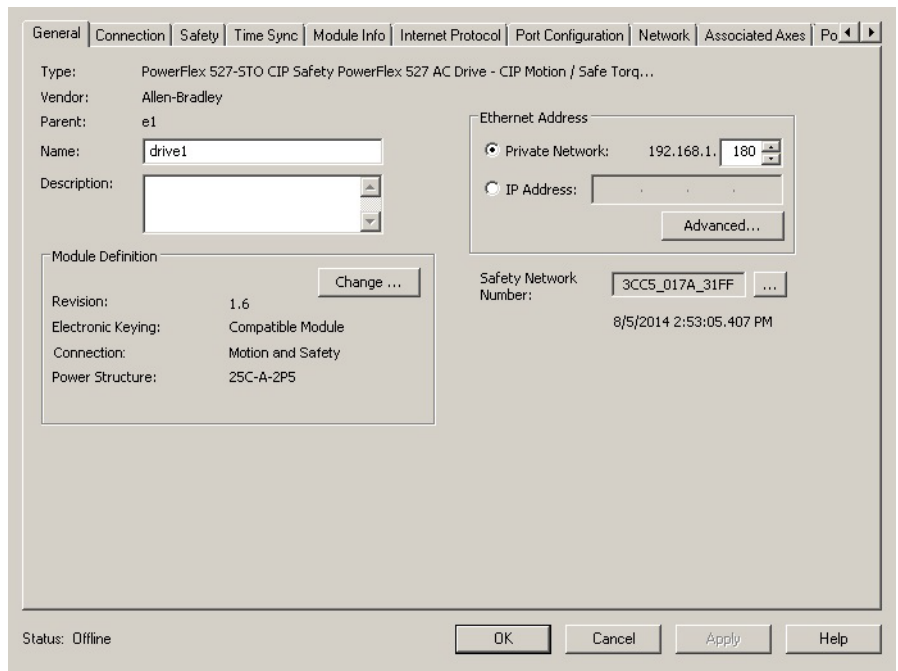

2. Click the Associated Axes tab.

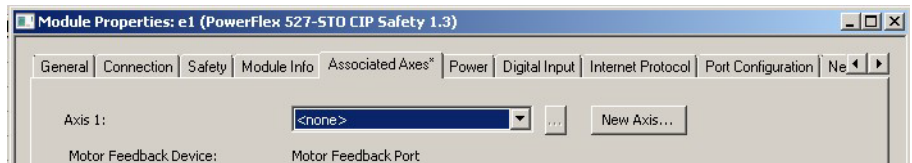

3. Click New Axis.

The New Tag dialog box appears.

The 'New Tag' dialog box contains the following fields and options:

- Name:
- Description:
- Usage:
- Type:
- Alias For:
- Data Type:
- Scope:
- External Access:
- Style:
- Constant
- Open AXIS\_CIP\_DRIVE Configuration

Buttons:

4. Type the axis Name.  
AXIS\_CIP\_DRIVE is the default Data Type.
5. Click Create.

The axis (Axis\_1 in this example) appears in the Controller Organizer under Motion Groups > Ungrouped Axes and is assigned as Axis 1.

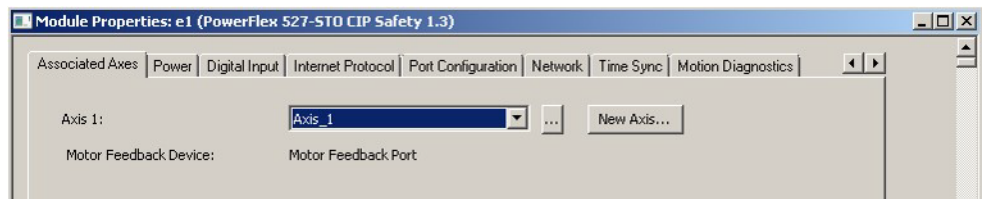
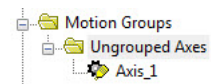

6. Click Apply.

7. Click the Power tab.

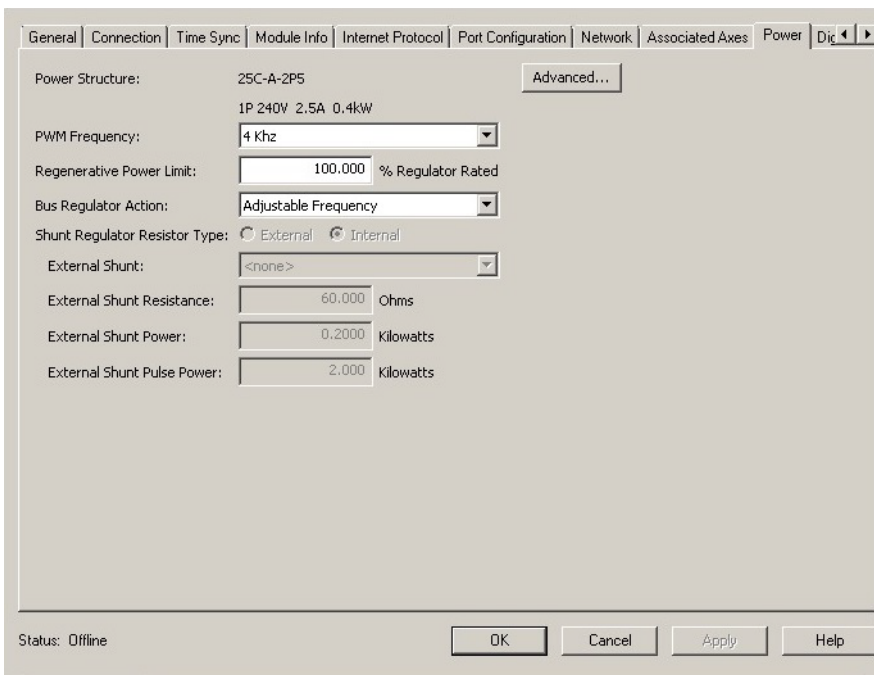

8. From the pull-down menu, choose the power options appropriate for your actual hardware configuration.

Attribute	Menu	Description
PWM Frequency	<ul style="list-style-type: none"> <li>2 kHz</li> <li>4 kHz (Default)</li> <li>8 kHz</li> </ul>	The value sets the carrier frequency for the Pulse Width Modulation (PWM) output to the motor. See the <a href="#">PWM Frequency Chart on page 67</a> for derating guidelines.
Bus Regulator Action	Disabled	This selection disables the internal DC bus voltage regulation feature of the drive. Select this option if there is an external regenerative brake or regenerative line supply that is connected to the drive DC bus.
	Shunt Regulator	This selection is used when either an external shunt resistor is connected to the drive or the internal IGBT will be controlling the power dissipation to the resistor (the type of shunt resistor is selected below).
	Adjustable Frequency (Default)	This selection allows the drive to either change the torque limits or ramp rate of the velocity to control the DC bus voltage. This option is not recommended for positioning applications because it will override the velocity and the system will overshoot or may not stop.
	Shunt then Adjustable Frequency	This selection allows the shunt resistor to absorb as much energy as it is designed for, then transitions to adjustable frequency control if the limit of the resistor has been reached.
	Adjustable Frequency then Shunt	This selection allows for adjustable frequency control of the DC bus. If adjustable frequency control cannot maintain the DC bus within limits, the shunt resistor will be activated.
Shunt Regulator Resistor Type	Internal	Not applicable for PowerFlex 527 drives.
	External	Enables the external shunt (internal shunt option is disabled).

9. Click OK.

10. Repeat [step 1](#) through [step 9](#) for each PowerFlex 527 drive.

### PWM Frequency Chart

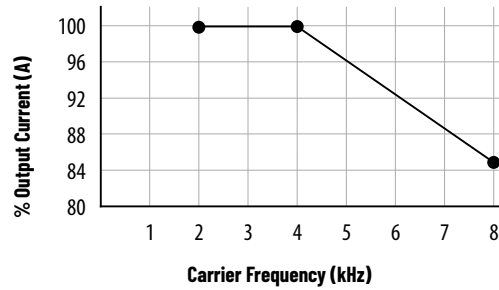

**IMPORTANT** Ignoring derating guidelines can cause reduced drive performance. The drive may automatically reduce the PWM carrier frequency at low output speeds, unless prevented from doing so.

### Configure the Motion Group

Follow these steps to configure the motion group.

1. In the Controller Organizer, right-click Motion Groups and choose New Motion Group.

The New Tag dialog box appears.

The New Tag dialog box contains the following fields and options:

- Name: UM\_Motion
- Description: (empty text area)
- Usage: <normal>
- Type: Base
- Alias For: (empty dropdown)
- Data Type: MOTION\_GROUP
- Scope: UM\_Controller
- External Access: Read/Write
- Style: (empty dropdown)
- Constant:
- Open MOTION\_GROUP Configuration:

2. Type the new motion group Name.
3. Click Create.

Your new motion group appears in the Controller Organizer under the Motion Groups folder.

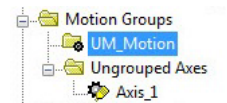



- Right-click the new motion group and choose Properties. The Motion Group Properties dialog box appears.

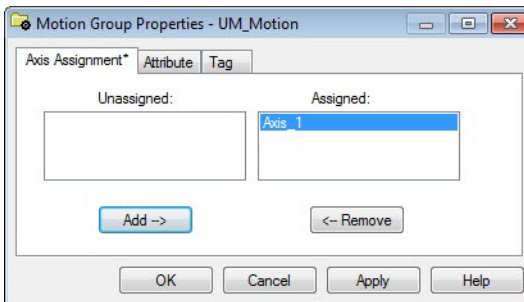

- Click the Axis Assignment tab and move your axes (created earlier) from Unassigned to Assigned.
- Click the Attribute tab and edit the default values as appropriate for your application.
- Click OK.

Your axis moves to the new motion group.

To get the minimum motion group base update rate, see [Motion Group Base Update Rate on page 161](#).

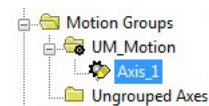

### Configure Axis Properties

Axis configuration depends on the motor or other devices (for example, an external encoder) associated with each axis. This section provides guidelines for configuring induction motors.

- [Configure Induction Motor Axis Properties \(Frequency Control\)](#)
- [Configure Induction Motors Axis Properties \(Velocity Loop\) on page 72](#)
- [Configure Induction Motors Axis Properties \(Position Loop\) on page 76](#)

#### *Configure Induction Motor Axis Properties (Frequency Control)*

The PowerFlex 527 drives support basic Volts/Hertz (V/Hz), Fan/Pump Volts/Hertz, Sensorless Vector Control (SVC), and Sensorless Vector Control (SVC) Economy frequency control methods.

Follow these steps to configure the induction motor axis properties.

- In the Controller Organizer, right-click an axis and choose Properties.

- Select the General category.  
The General and Associated Module dialog box appears.

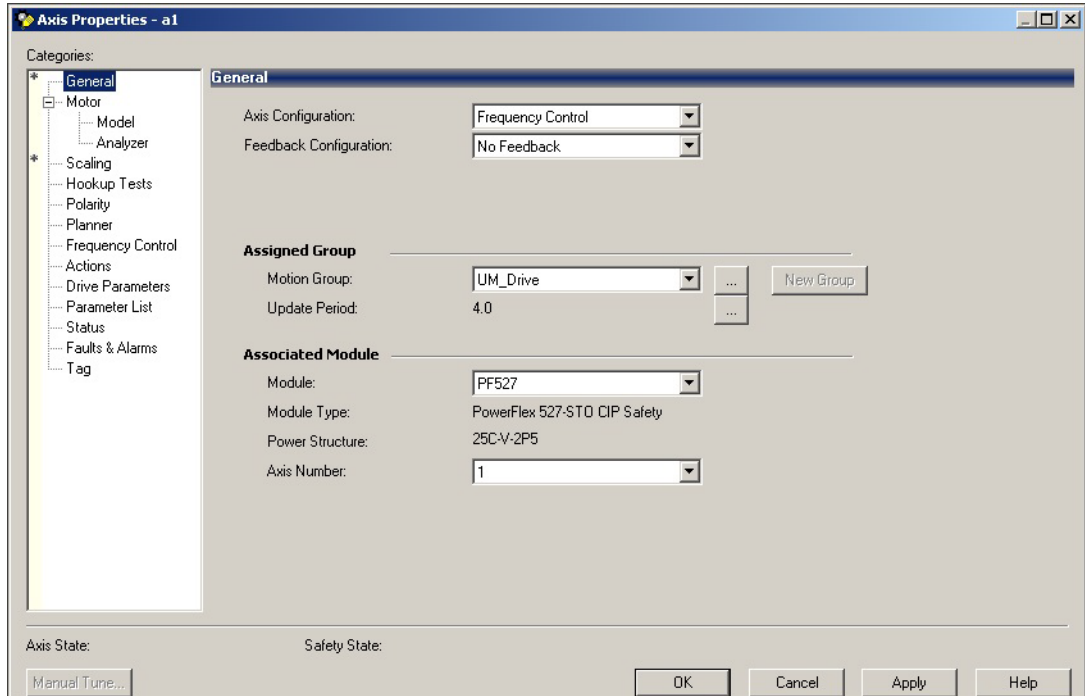

- From the Axis Configuration pull-down menu, choose Frequency Control.
- From the Module pull-down menu, choose your PowerFlex 527 drive.  
The Module Type and Power Structure fields populate with the chosen drive catalog number.
- Click Apply.
- Select the Motor category.  
The Motor Device Specification dialog box appears.

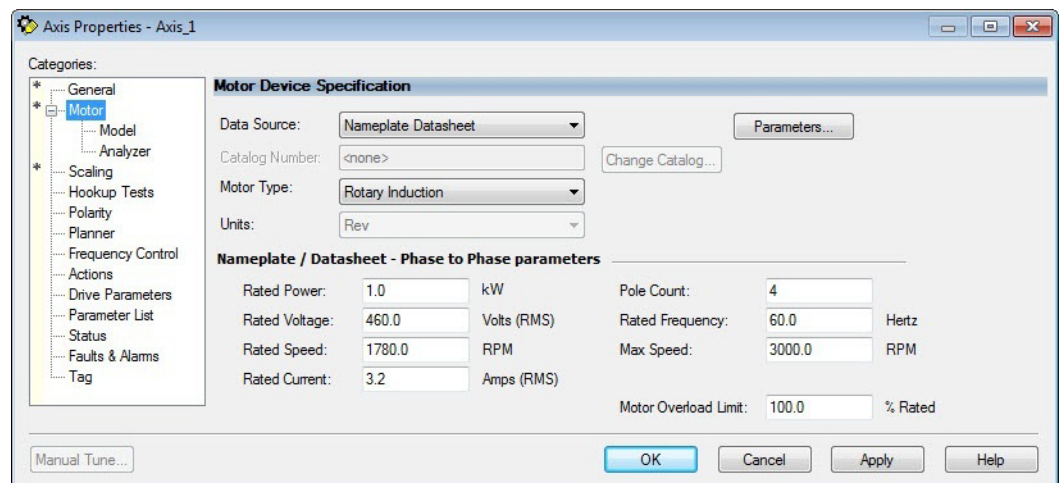

- From the Data Source pull-down menu, choose Nameplate Datasheet.  
This is the default setting.
- From the Motor Type pull-down menu, choose Rotary Induction.
- From the motor Nameplate / Datasheet, enter the Phase to Phase values.
- Click Apply.
- Select the Frequency Control category.

The Frequency Control dialog box appears.

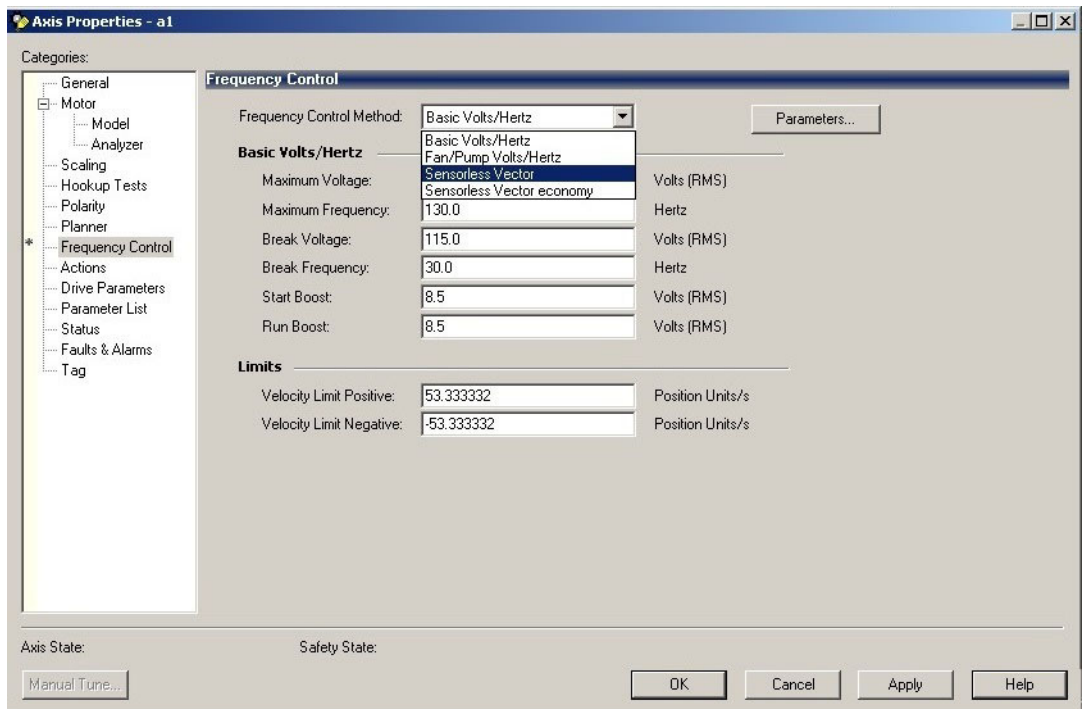

12. From the Frequency Control Method pull-down menu, choose the method appropriate for your application.
13. If you chose the Basic Volts/Hertz method, enter the nameplate data for your motor in the Basic Volts/Hertz fields.  
If you chose the Sensorless Vector method, the Basic Volts/Hertz fields are dimmed.
14. Click Apply.
15. If you chose the Sensorless Vector or Sensorless Vector Economy method, select the Motor > Analyzer category.

The Analyze Motor to Determine Motor Model dialog box appears.

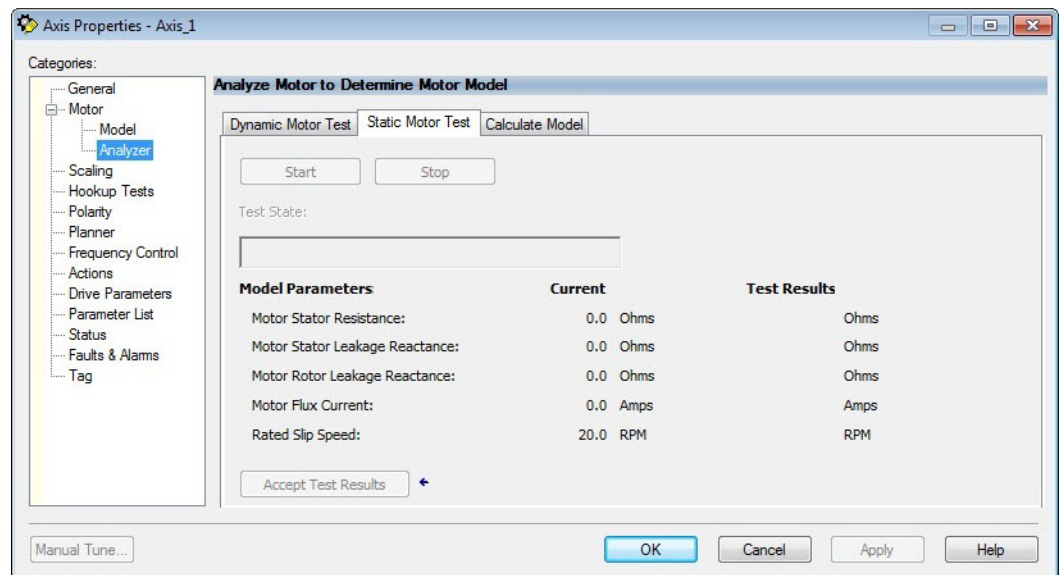

16. Click the Static Motor Test tab.
17. Click Start to run the test and measure Motor Stator Resistance.  
If you chose the Basic Volts/Hertz category, you can skip this test.

## 18. Select the Actions category.

The Actions to Take Upon Conditions dialog box appears.

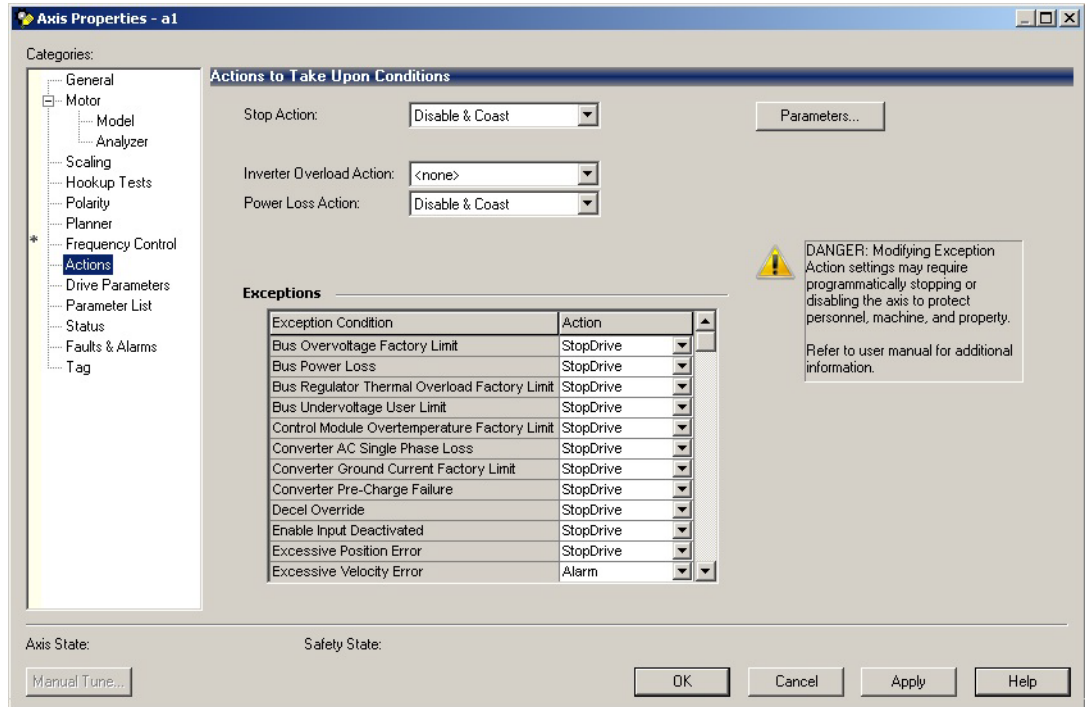

From this dialog box, you can program actions and change the action for exceptions (faults). See [Logix 5000 Controller and Drive Behavior on page 123](#) for more information.

Some out-of-box (OOB) settings will need to be applied here. See [Recommended Out-of-Box Settings on page 159](#) for more information.

## 19. Select the Parameter List category.

The Motion Axis Parameters dialog box appears.

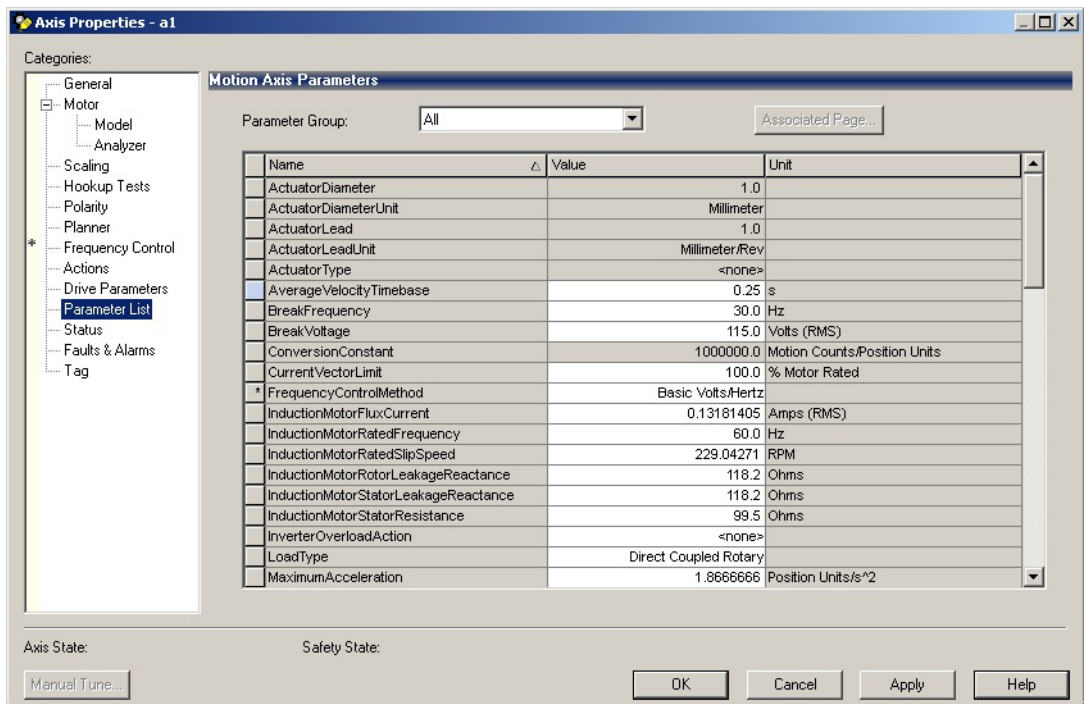

From this dialog box, you can program actions and change the action for exceptions (faults). See [Logix 5000 Controller and Drive Behavior on page 123](#) for more information.

To obtain the best performance from the drive regardless of which control method you are using, you should configure the recommended out-of-box settings as described in [Recommended Out-of-Box Settings on page 159](#) first before configuring further for your application.

20. Click OK.
21. Repeat [step 1](#) through [step 20](#) for each induction motor axis.

### Configure Induction Motors Axis Properties (Velocity Loop)

Follow these steps to configure the induction motor axis properties.

1. In the Controller Organizer, right-click an axis and choose Properties.
2. Select the General category.

The General and Associated Module dialog box appears.

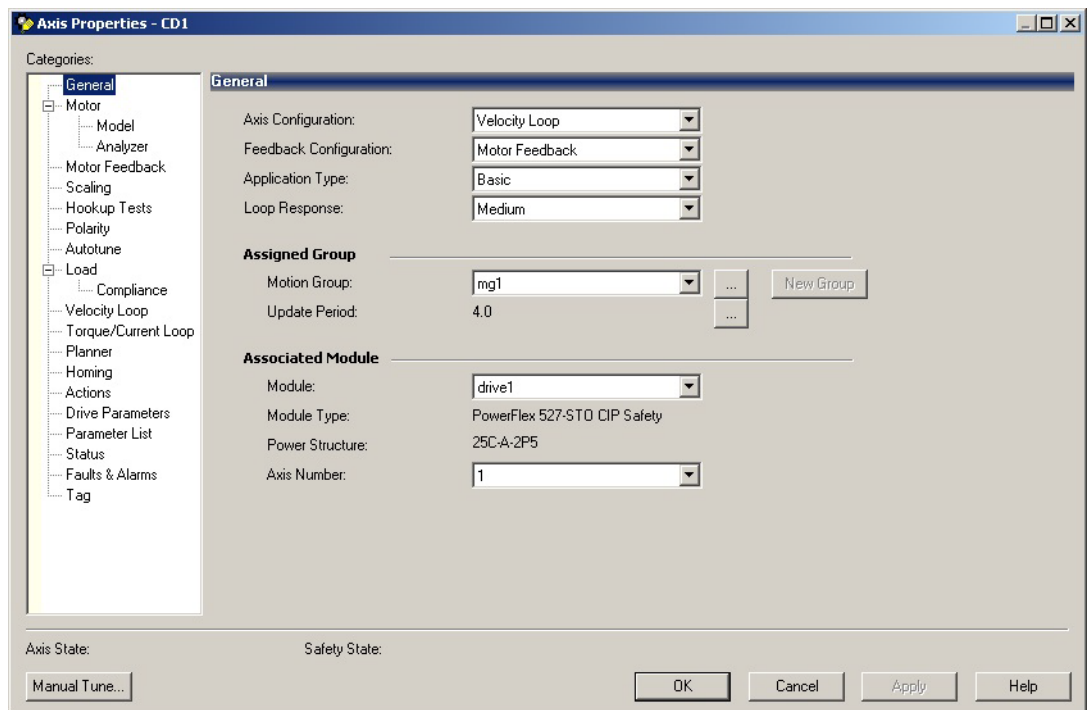

3. From the Axis Configuration pull-down menu, choose Velocity Loop.
4. From the Module pull-down menu, choose your PowerFlex 527 drive. The Module Type and Power Structure fields populate with the chosen drive catalog number.
5. Click Apply.

6. Select the Motor category.  
The Motor Device Specification dialog box appears.

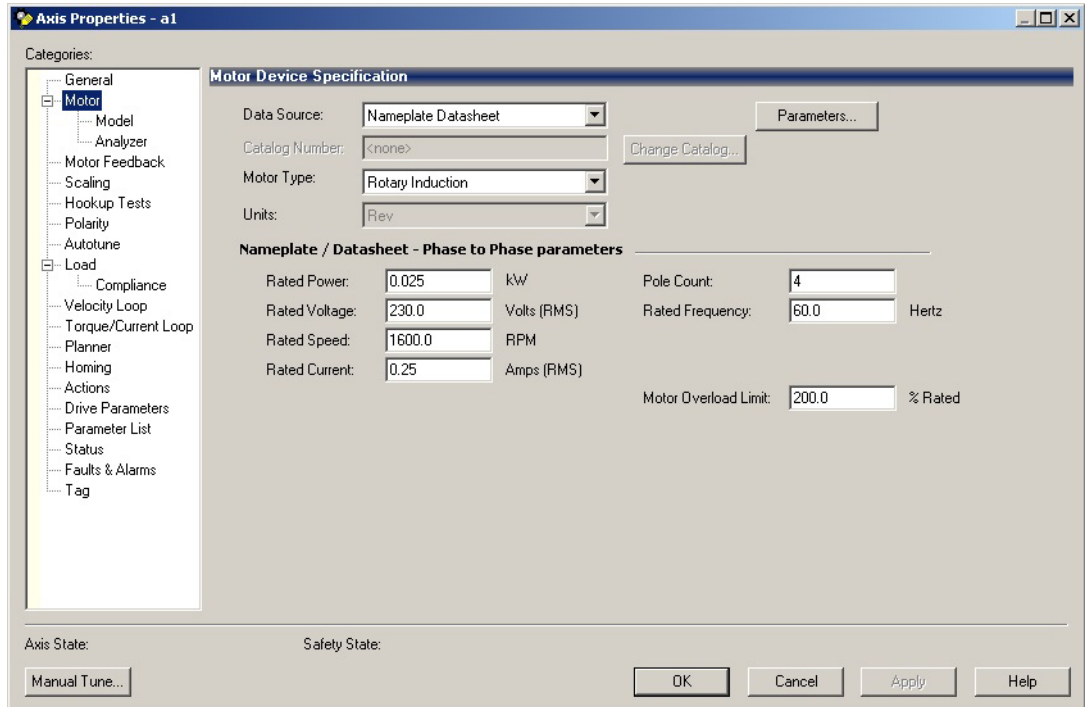

7. From the Data Source pull-down menu, choose Nameplate Datasheet.  
This is the default setting.
8. From the Motor Type pull-down menu, choose Rotary Induction.
9. From the motor Nameplate / Datasheet, enter the Phase to Phase values.
10. Click Apply.
11. Select the Motor Feedback category.

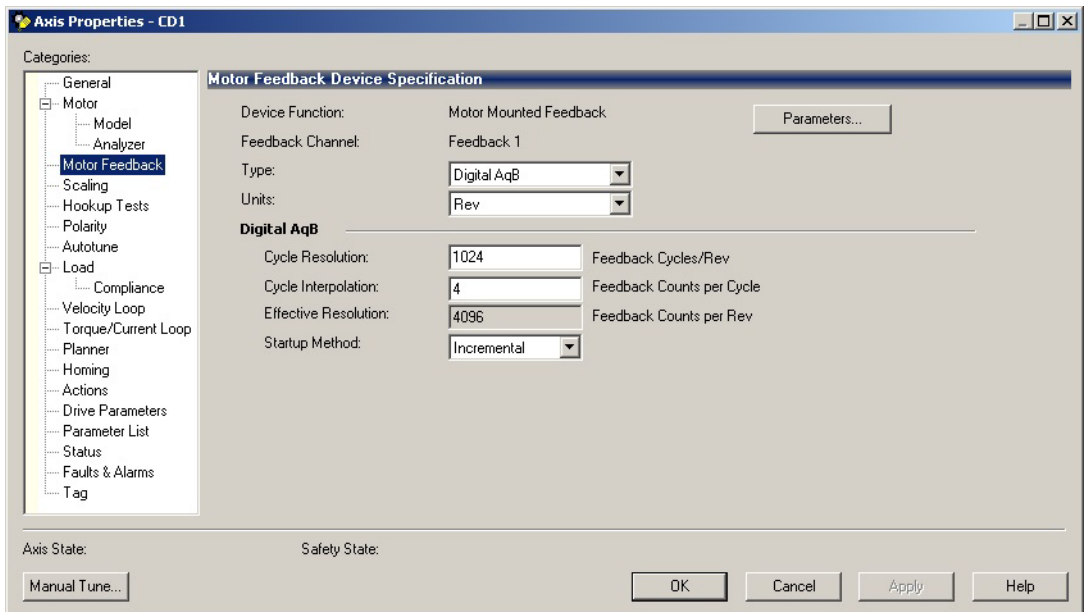

12. Enter the specifications of your encoder into the fields.
13. Click Apply.



14. Select the Scaling category and edit the values as appropriate for your application.

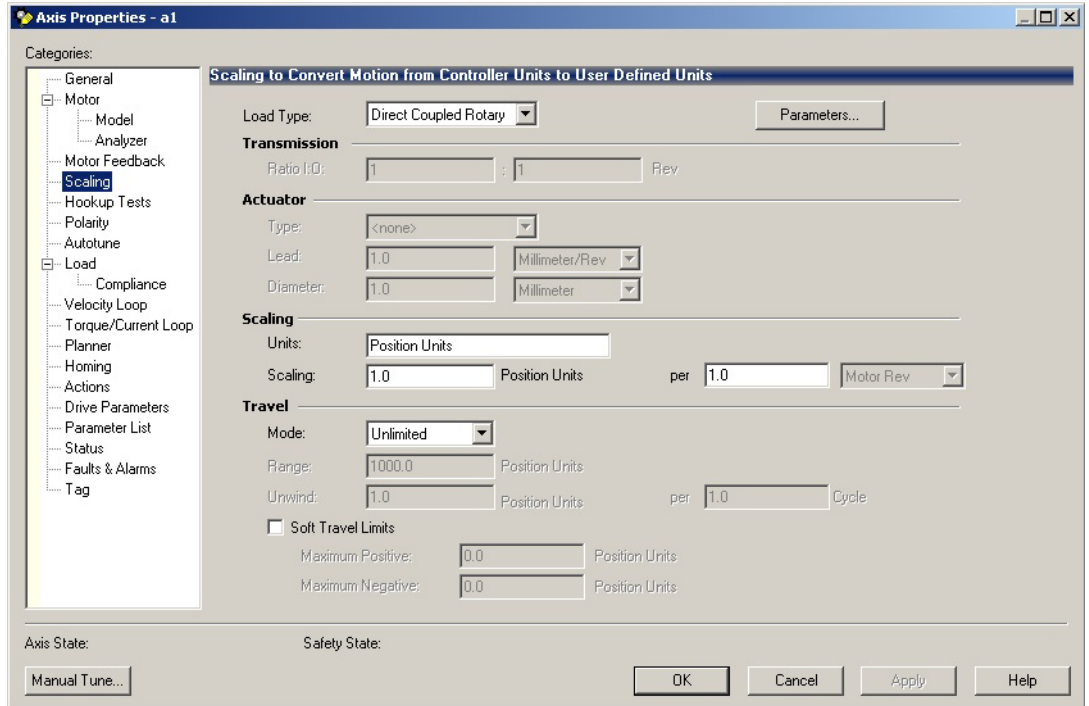

15. Click Apply if you make changes.

16. Select the Actions category.

The Actions to Take Upon Conditions dialog box appears.

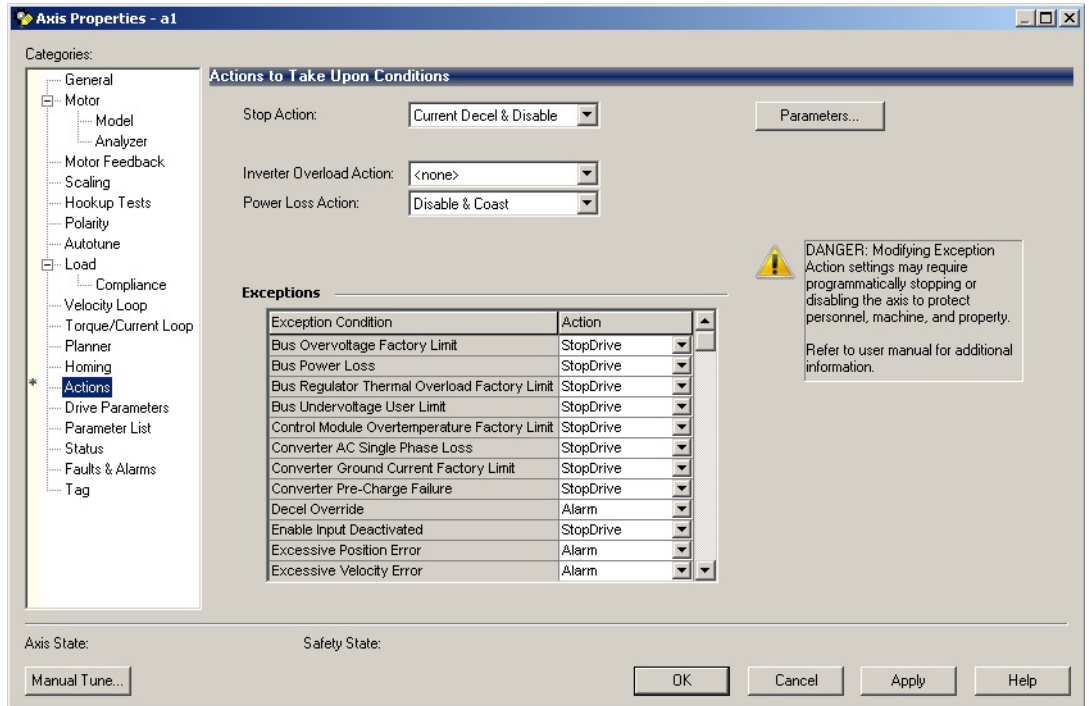

From this dialog box, you can program actions and change the action for exceptions (faults). See [Logix 5000 Controller and Drive Behavior on page 123](#) for more information.

Some out-of-box (OOB) settings will need to be applied here. See [Recommended Out-of-Box Settings on page 159](#) for more information.

17. Select the Parameter List category.  
The Motion Axis Parameters dialog box appears.

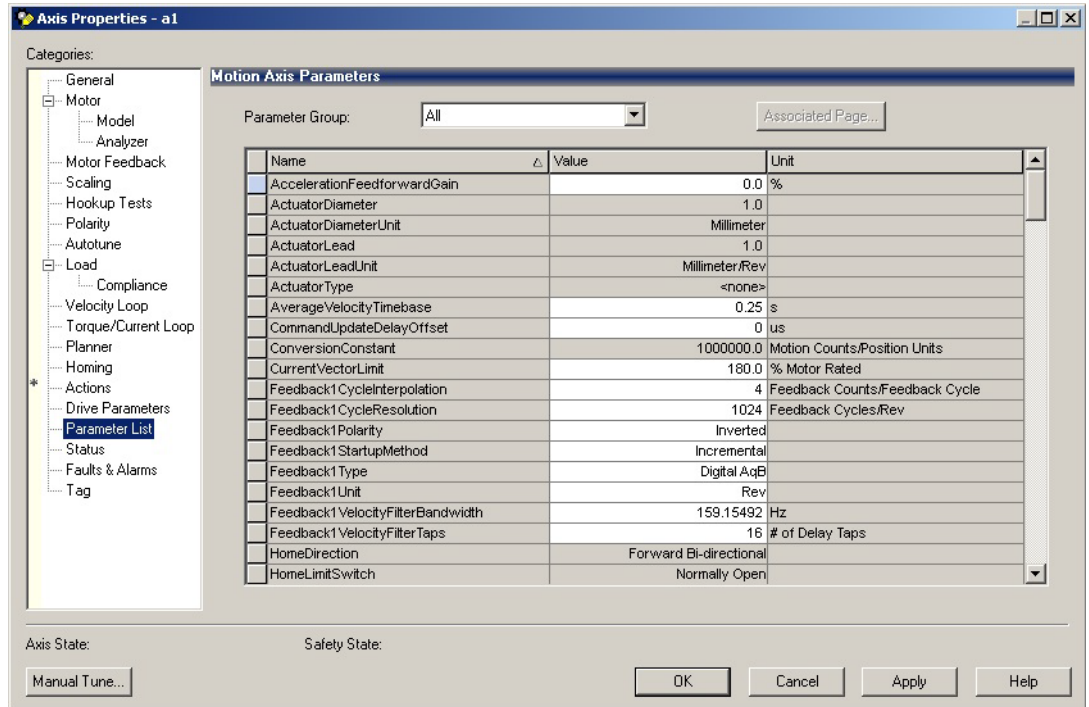

From this dialog box, you can program actions and change the action for exceptions (faults). See [Logix 5000 Controller and Drive Behavior on page 123](#) for more information.

To obtain the best performance from the drive regardless of which control method you are using, you should configure the recommended out-of-box settings as described in [Recommended Out-of-Box Settings on page 159](#) first before configuring further for your application.

18. Click OK.
19. Repeat [step 1](#) through [step 18](#) for each induction motor axis.



### Configure Induction Motors Axis Properties (Position Loop)

Follow these steps to configure the induction motor axis properties.

1. In the Controller Organizer, right-click an axis and choose Properties.
2. Select the General category.

The General and Associated Module dialog box appears.

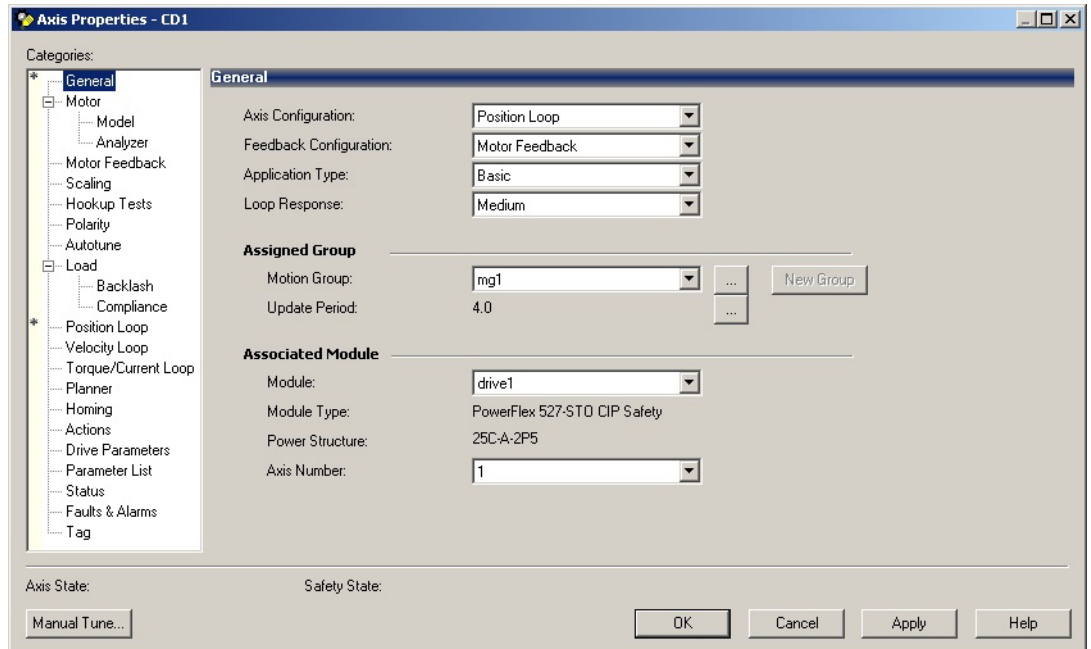

3. From the Axis Configuration pull-down menu, choose Position Loop.
4. From the Module pull-down menu, choose your PowerFlex 527 drive.  
The Module Type and Power Structure fields populate with the chosen drive catalog number.
5. Click Apply.

6. Select the Motor category.  
The Motor Device Specification dialog box appears.

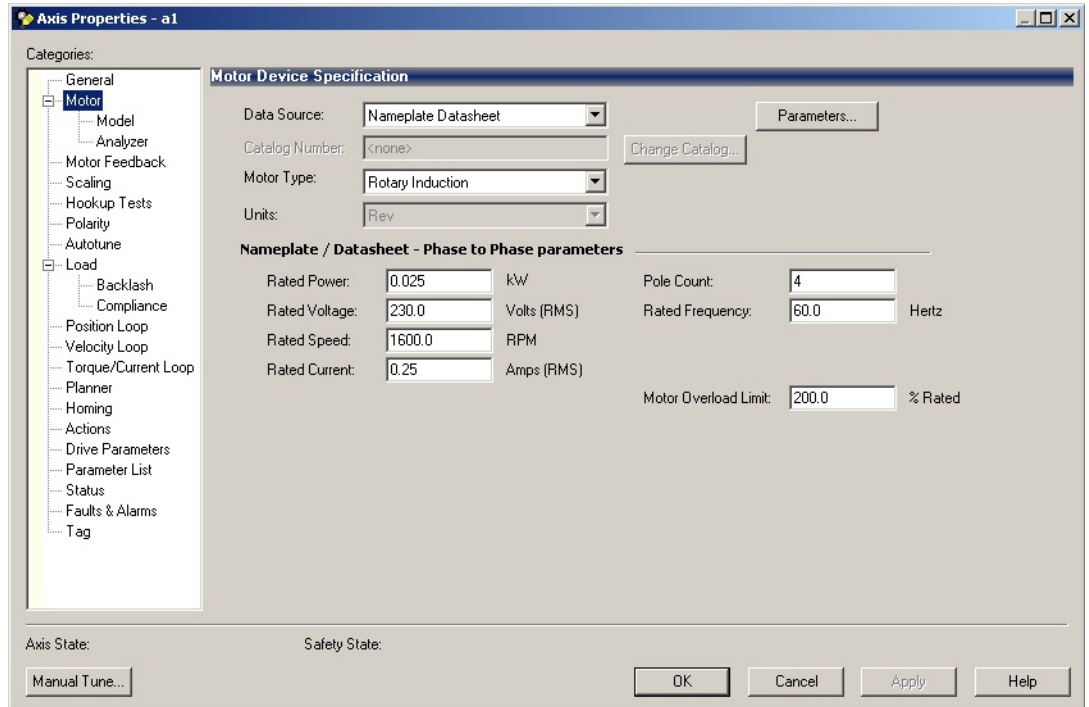

7. From the Data Source pull-down menu, choose Nameplate Datasheet. This is the default setting.
8. From the Motor Type pull-down menu, choose Rotary Induction.
9. From the motor Nameplate / Datasheet, enter the Phase to Phase values.
10. Click Apply.
11. Select the Motor Feedback category.

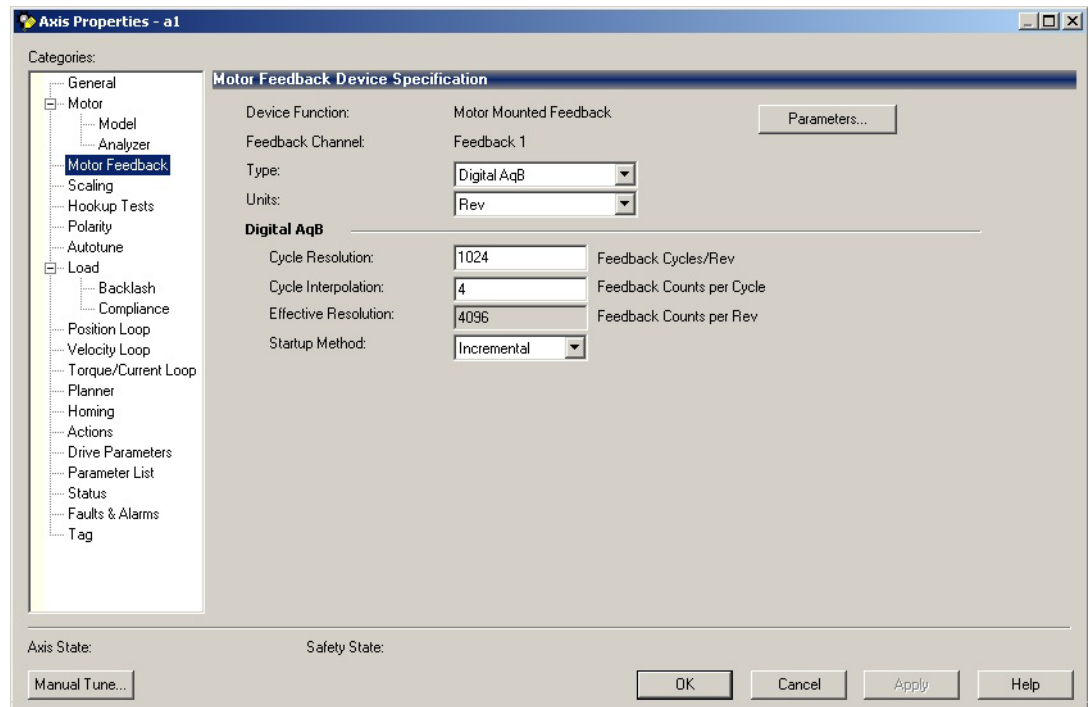

12. Enter the specifications of your encoder into the fields.
13. Click Apply.

14. Select the Scaling category and edit the values as appropriate for your application.

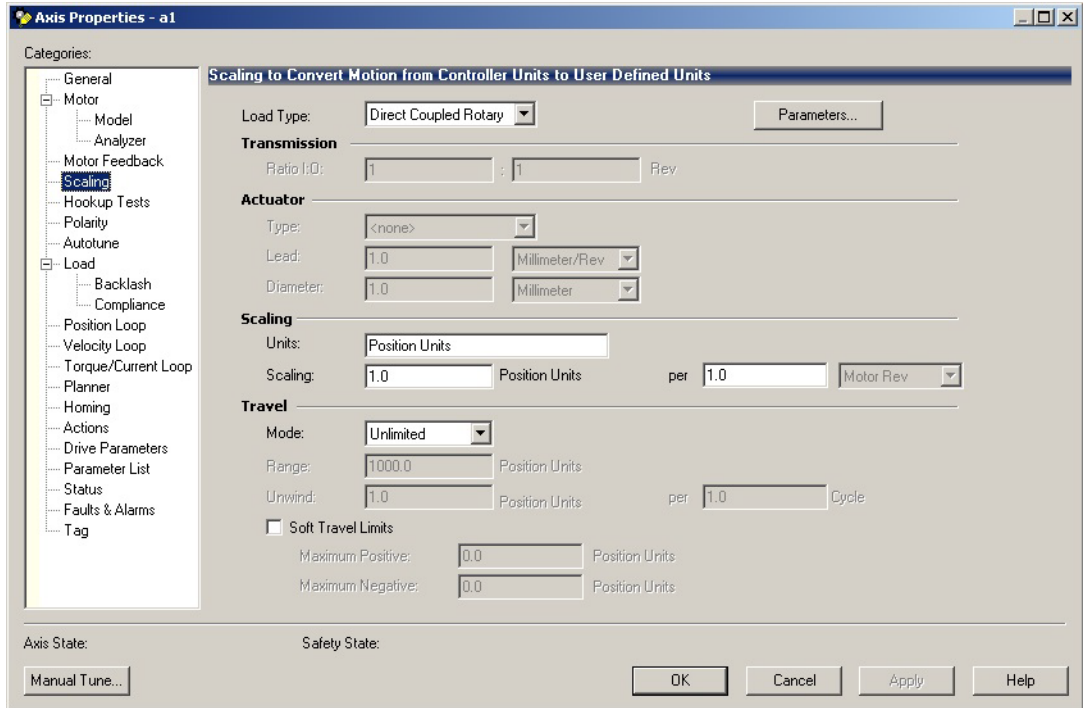

15. Click Apply if you make changes.
16. Select the Actions category.  
The Actions to Take Upon Conditions dialog box appears.

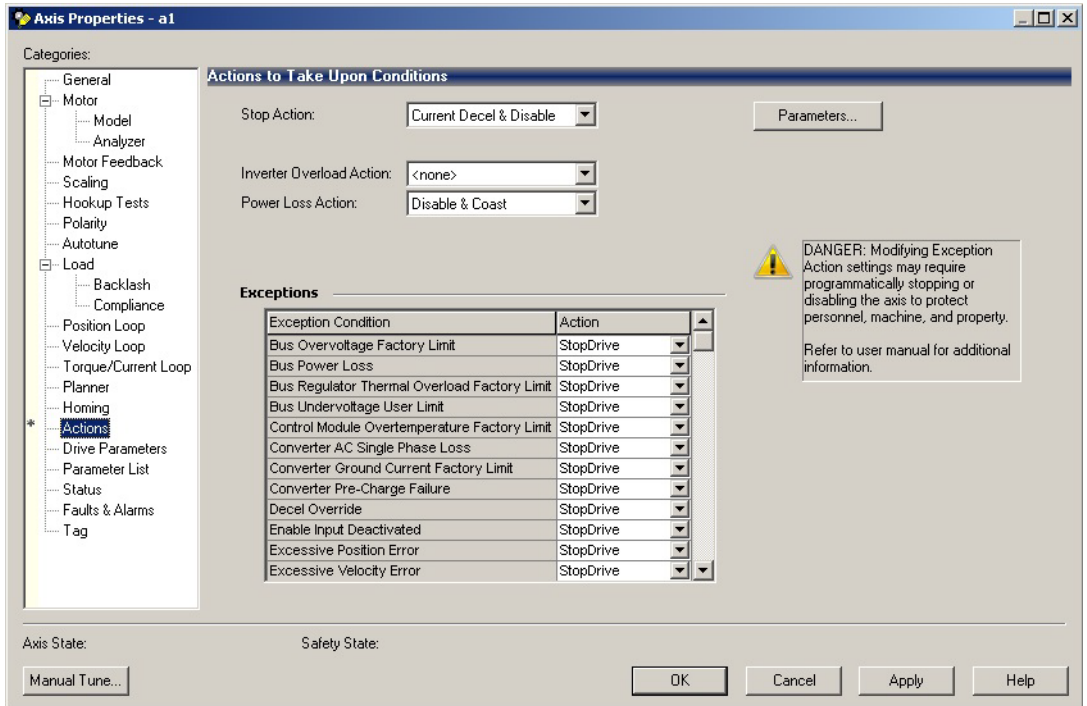

From this dialog box, you can program actions and change the action for exceptions (faults). See [Logix 5000 Controller and Drive Behavior on page 123](#) for more information.

Some out-of-box (OOB) settings will need to be applied here. See [Recommended Out-of-Box Settings on page 159](#) for more information.

17. Select the Parameter List category.  
The Motion Axis Parameters dialog box appears.

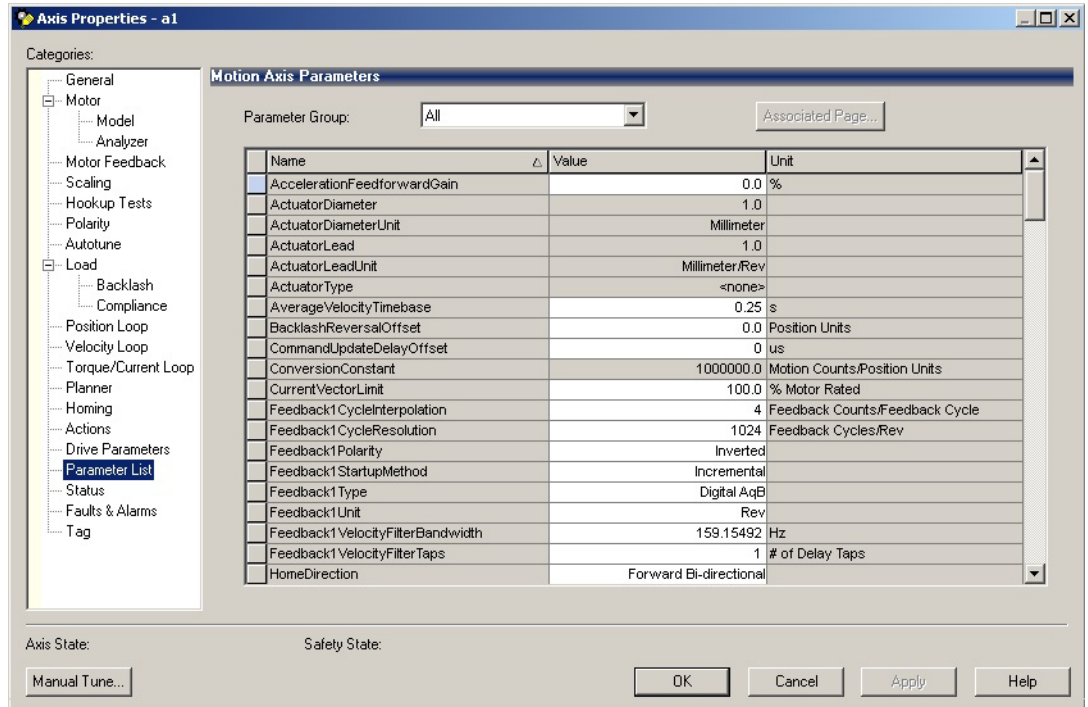

From this dialog box, you can program actions and change the action for exceptions (faults). See [Logix 5000 Controller and Drive Behavior on page 123](#) for more information.

To obtain the best performance from the drive regardless of which control method you are using, you should configure the recommended out-of-box settings as described in [Recommended Out-of-Box Settings on page 159](#) first before configuring further for your application.

18. Click OK.
19. Repeat [step 1](#) through [step 18](#) for each induction motor axis.

## Download the Program

After completing the Logix Designer application and saving the file, you must download your program to the Logix 5000 controller.

## Apply Power to the PowerFlex 527 Drive

This procedure assumes that you have done the following:

- Wired and configured your PowerFlex 527 system and your Logix 5000 controller.
- Downloaded the project to the controller.
- Connected the Ethernet port to the drive.

If you have not done the steps that are listed above, you will achieve a different result in [step 5](#).



**SHOCK HAZARD:** To avoid hazard of electrical shock, perform all mounting and wiring of the PowerFlex 527 drives before applying power. Once power is applied, connector terminals can have voltage present even when not in use.

Follow these steps to apply power to the PowerFlex 527 system.

1. Disconnect the load to the motor.



**ATTENTION:** To avoid personal injury or damage to the equipment, disconnect the load to the motor. Make sure that each motor is free of all linkages when initially applying power to the system.

2. Apply AC power.

The LCD display begins the startup sequence. See [Startup Sequence on page 48](#) for more information.

3. When the startup sequence completes, verify that the MOD and NET status indicators are steady green.

If the two status indicators are not solid green, see [PowerFlex 527 Drive Status Indicators on page 120](#) for more information.

4. Monitor the DC Bus voltage on the LCD display. See [Real-time Information Display on page 51](#) for more information.

If the DC Bus does not reach the expected voltage level, check the 3-phase input power connections. Also it can take as many as 1.8 seconds after input power is applied before the drive can accept motion commands.

5. Verify that the axis state changes to STOPPED.

If the axis state does not change to STOPPED, see [Fault Codes on page 116](#).

## Test and Tune the Axes - Velocity and Position Control Modes

This procedure assumes that you have configured your PowerFlex 527 drive, your Logix 5000 controller, and applied power to the system.

**IMPORTANT** Before proceeding with testing and tuning your axes, verify that the MOD and NET status indicators are operating as described in [PowerFlex 527 Drive Status Indicators on page 120](#).

For help using the Logix Designer application as it applies to testing and tuning your axes with ControlLogix EtherNet/IP modules or CompactLogix 5370 controllers, see [Additional Resources on page 8](#).

### Test the Axes

**Note:** In the following example, the Axis Configuration is set to Position Loop.

Follow these steps to test the axes.



**ATTENTION:** Verify if drive I/O connection is in the running state and the axis is in a stopped state.

1. Verify that the load was removed from each axis.
2. In your Motion Group folder, right-click an axis and choose Properties. The Axis Properties dialog box appears.

- Click the Hookup Tests category.

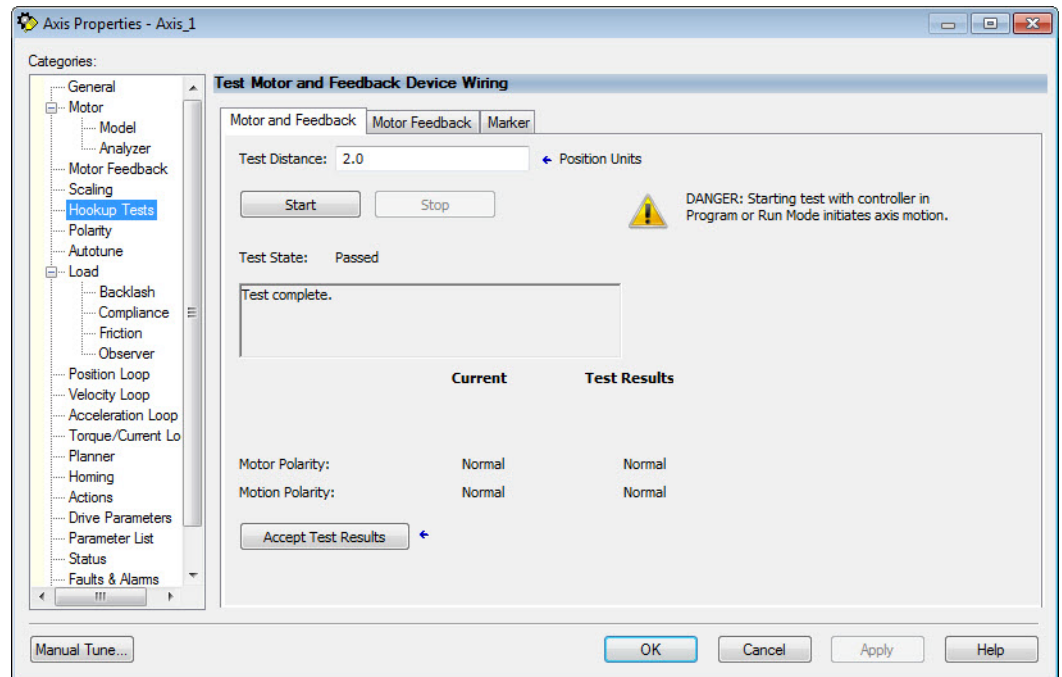

- In the Test Distance field, type 2.0 as the number of revolutions for the test.

Test	Description
Marker	Verifies marker detection capability as you rotate the motor shaft.
Motor Feedback	Verifies feedback connections are wired correctly as you rotate the motor shaft.
Motor and Feedback	Verifies motor power and feedback connections are wired correctly as you command the motor to rotate.

- Click the Motor Feedback tab.
- Click Start.
- Manually move the motor to the specific test distance. In this case, Step 4 dictated 2 revolutions.
- Click the Motor and Feedback tab.

The Marker and Motor Feedback tests are not supported in Frequency Control mode.

- Click Start.

The Logix Designer - Motor and Feedback Test dialog box appears. The Test State is Executing. TESTING appears on the drive LCD display.

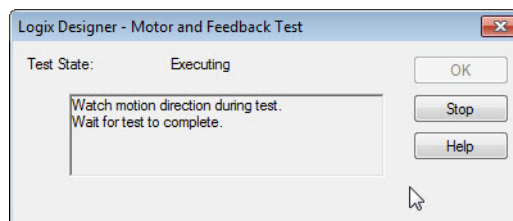

When the test completes successfully, the Test State changes from Executing to Passed.

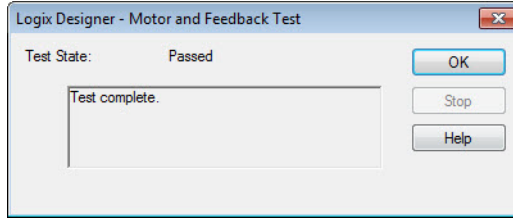

10. Click OK.

This dialog box appears asking if the direction was correct.

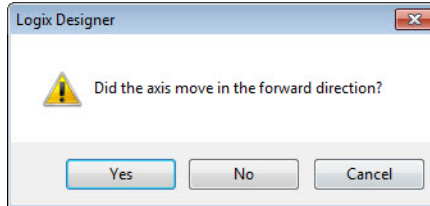

11. Click Yes.
12. Click Accept Test Results.
13. If the test fails, this dialog box appears.
  - a. Click OK.
  - b. Verify the DC Bus voltage.
  - c. Verify unit values entered in the Scaling category.
  - d. Return to [step 9](#) and run the test again.

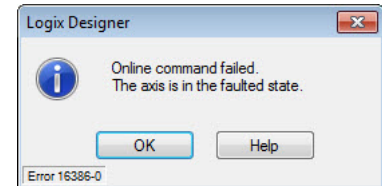

## Tune the Axes

Tuning the Axes is not applicable when using the Frequency Control method. Follow these steps to tune the axes.



**ATTENTION:** Verify if drive I/O connection is in the running state and the axis is in a stopped state.

1. Verify that the load is still removed from the axis being tuned.



**ATTENTION:** To reduce the possibility of unpredictable motor response, tune your motor with the load removed first, then reattach the load and perform the tuning procedure again to provide an accurate operational response.



- Click the Autotune category.

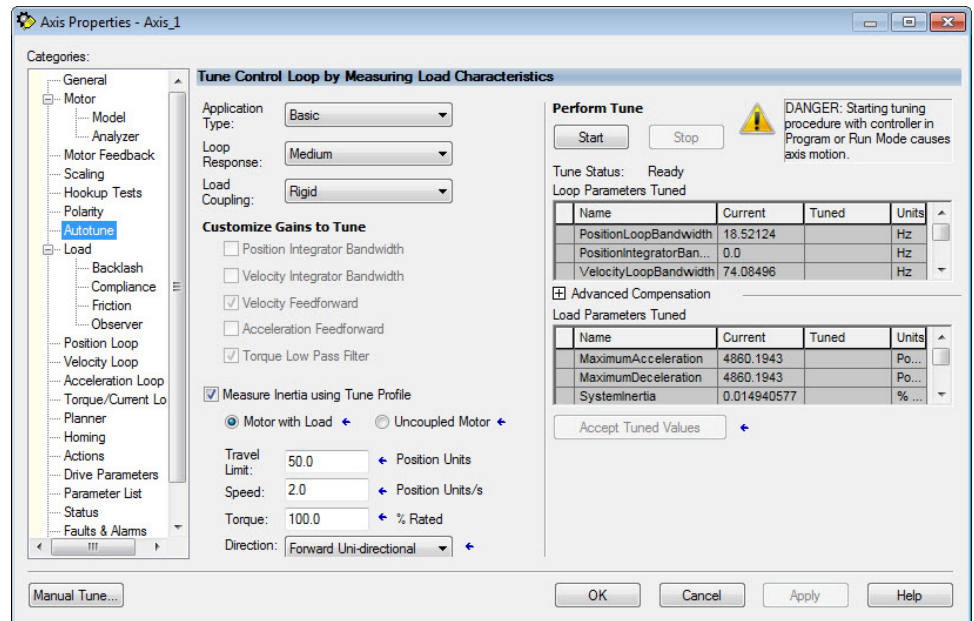

- Type values for Travel Limit and Speed.

In this example, Travel Limit = 5 and Speed = 10. The actual value of programmed units depending on your application.

- From the Direction pull-down menu, choose a setting appropriate for your application.

The default setting is Forward Uni-directional.

- Edit other fields as appropriate for your application.
- Click Start.

The Logix Designer - Autotune dialog box appears. When the test completes, the Test State changes from Executing to Success.

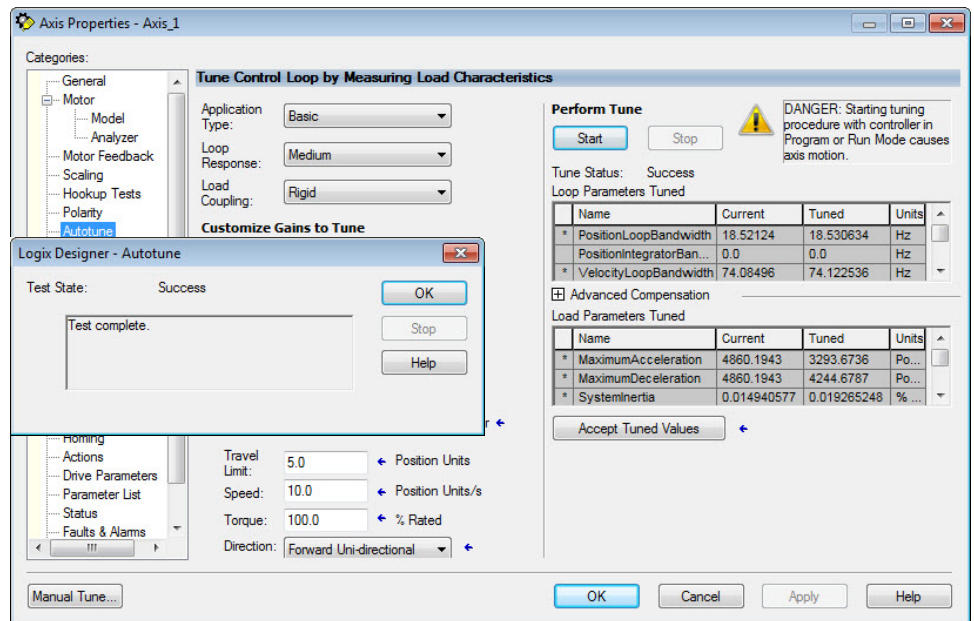

Tuned values populate the Loop and Load Parameters tables. Actual bandwidth values (Hz) depend on your application and can require adjustment once motor and load are connected.

- Click Accept Tuned Values.
- Click OK to close the Logix Designer - Autotune dialog box.



9. Click OK to close the Axis Properties dialog box.
10. If the test fails, this dialog box appears.
  - a. Click OK.
  - b. Make an adjustment to motor velocity.
  - c. See the Integrated Motion on the EtherNet/IP Network: Configuration and Startup User Manual, publication [MOTION-UM003](#) for more information.
  - d. Return to [step 6](#) and run the test again.
11. Repeat Test and Tune the Axes for each axis.

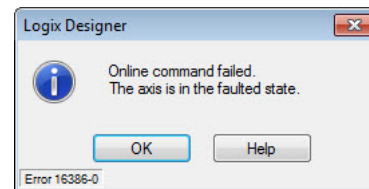

## PowerFlex 527 Integrated Safe Torque-Off

This chapter introduces you to how the PowerFlex 527 integrated safe torque-off feature meets the requirements of Performance Level e (PLe), Category 3 according to EN ISO 13849, and SIL CL3 according to IEC 61508, EN 61800-5-2, and EN 62061.

Topic	Page
Certification	85
Description of Operation	86
Probability of Dangerous Failure Per Hour (PFH)	86
Safe Torque-Off (STO) Feature	87
Out-of-Box (OOB) Safety State	88
Safe Torque-Off Status	90
Explicit Messages	91

### Certification

The TÜV Rheinland group has approved PowerFlex 527 drives with integrated safe torque-off for use in safety-related applications up to PLe, Category 3 according to EN ISO 13849, and SIL CL3 according to IEC 61508, EN 61800-5-2, and EN 62061, in which removing the motion-producing power is considered to be the safe state.

See [CE Conformity on page 37](#) for more information regarding certification.

### Important Safety Considerations

The system user is responsible for the following:

- Validation of any sensors or actuators connected to the system.
- Completing a machine-level risk assessment.
- Certification of the machine to the desired EN ISO 13849 performance level or EN 62061 SIL level.
- Project management and proof testing performed in accordance with EN ISO 13849.

### Category 3 Requirements According to ISO 13849

Safety-related parts are designed with these attributes:

- A single fault in any of these parts does not lead to the loss of the safety function.
- A single fault is detected whenever reasonably practicable.
- Accumulation of undetected faults can lead to the loss of the safety function and a failure to remove motion producing power from the motor.

## Stop Category Definition

Stop category 0 as defined in EN 60204 or Safe Torque-Off as defined by EN 61800 5 2 is achieved with immediate removal of motion-producing power to the actuator.

---

**IMPORTANT** In the event of a malfunction, the most likely stop category is category 0. When designing the machine application, timing and distance must be considered for a coast to stop. For more information regarding stop categories, refer to EN 60204-1.

---

## Performance Level (PL) and Safety Integrity Level (SIL)

For safety-related control systems, Performance Level (PL), according to EN ISO 13849, and SIL levels, according to EN 61508 and EN 62061, include a rating of the system's ability to perform its safety functions. All of the safety-related components of the control system must be included in both a risk assessment and the determination of the achieved levels.

Refer to the EN ISO 13849, EN 61508, and EN 62061 standards for complete information on requirements for PL and SIL determination.

## Description of Operation

The Safe Torque-Off (STO) feature provides a method, with sufficiently low probability of failure, to force the power-transistor control signals to a disabled state. When the command to allow torque ceases, all of the drive output-power transistors are released from the On state. This results in a condition where the motor is coasting (stop category 0). Disabling the power transistor output does not provide mechanical isolation of the electrical output that is required for some applications.

The PowerFlex 527 drive STO function response time is less than 12 ms. Response time is the delay between the time the drive STO function receives the STO request and the time when motion producing power is removed from the motor.

## Probability of Dangerous Failure Per Hour (PFH)

Safety-related systems are classified as operating in a High-demand/continuous mode where the frequency of demands for operation made on a safety-related system is greater than once per year.

The SIL value for a High-demand/continuous mode safety-related system is directly related to the probability of a dangerous failure occurring per hour (PFH).

### PFH Data

This PFH calculation is based on the equations from EN 61508 and show worst-case values.

Determination of safety parameters is based on the assumptions that the system operates in High-demand mode and that the safety function is requested at least once a year.

[Table 6](#) provides data for a 20-year proof test interval and demonstrates the worst-case effect of various configuration changes on the data.

---

**IMPORTANT** Determination of safety parameters is based on the assumptions that the system operates in High-demand mode and that the safety function is requested at least once every three months.

---

**Table 6 - PFD and PFH Data**

Attribute	Value (Hardwired and Network)
PFD (average)	1.53E-4
PFH	1.91E-9
SIL CL	3
PL	e
Category	3
MTTFd (years)	166
DCavg (%)	90 (medium)
HFT	1(1002)
Mission time (years)	20

## Safe Torque-Off (STO) Feature

The safe torque-off circuit, when used with suitable safety components, provides protection according to EN ISO 13849 (PLe), Category 3 or according to IEC EN 61508, EN 61800-5-2, and EN 62061 (SIL CL3). All components in the system must be chosen and applied correctly to achieve the desired level of operator safeguarding.

The safe torque-off circuit is designed to safely turn off all of the output-power transistors. You can use the safe torque-off circuit in combination with other safety devices to achieve the stop and protection-against-restart as specified in IEC 60204-1.



**ATTENTION:** This option is suitable only for performing mechanical work on the drive system or affected area of a machine. It does not provide electrical safety.



**SHOCK HAZARD:** In Safe Torque-Off mode, hazardous voltages can still be present at the drive. To avoid an electric shock hazard, disconnect power to the system and verify that the voltage is zero before performing any work on the drive.

### Safe Torque-Off Feature Bypass

PowerFlex 527 drives do not operate without a safety circuit or safety bypass wiring. For applications that do not require the safe torque-off feature, you must install jumper wires to bypass the safe torque-off circuitry.

PowerFlex 527 drives ship with the safety control in the out-of-box state and with a safety bypass jumper in place. In this configuration, the PowerFlex 527 safe torque-off function is disabled.

### Safe Torque-Off Bypass Wiring

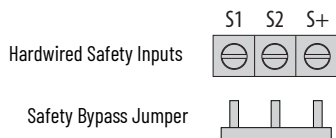

**IMPORTANT** If safe torque-off is not required, the drive must be returned to the as-shipped safety configuration to allow operation.

**IMPORTANT** If the Safety Bypass Jumper is misplaced, it is acceptable to wire the S1, S2, and S+ input terminals together.

### As-Shipped Safety Configuration

The PowerFlex 527 drive is shipped with:

- Safety control in out-of-box state
- Safety Bypass Jumper installed

In this configuration, the PowerFlex 527 safe torque-off function is disabled.

## Out-of-Box (OOB) Safety State

The PowerFlex 527 drives ship in the out-of-box safety state.

### Recognizing the Out-of-Box State

The safety control state can be read from the axis tag `AxisSafetyState`, or by using a MSG command in the Logix Designer application to read the Safety Supervisor State.

If the state is “Waiting for TUNID” (8) or “Waiting for TUNID with Torque Permitted” (51), then the safety control is in the out-of-box state.

**Table 7 - Safety Supervisor State: Values**

Value	Definition	Definition	Mode
2	Idle	No active connections	Network
4	Executing	Normal running state	Network
7	Configuring	Transition state	Network
8	Waiting for TUNID	Out-of-Box state	Hardwired
51	Waiting for TUNID with Torque Permitted	Out-of-Box state	Hardwired
52	Executing with Torque Permitted	STO Bypass state	Network

### Restoring the Drive to the Out-of-Box State

After the integrated safety connection configuration is applied to the PowerFlex 527 drive at least once, you can follow these steps to restore your PowerFlex 527 drive to the out-of-box state.

1. Right-click the PowerFlex 527 drive you created, and choose Properties.

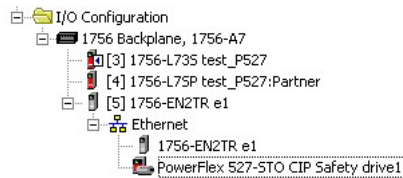

Click the Connection tab.

The Connection tab appears.

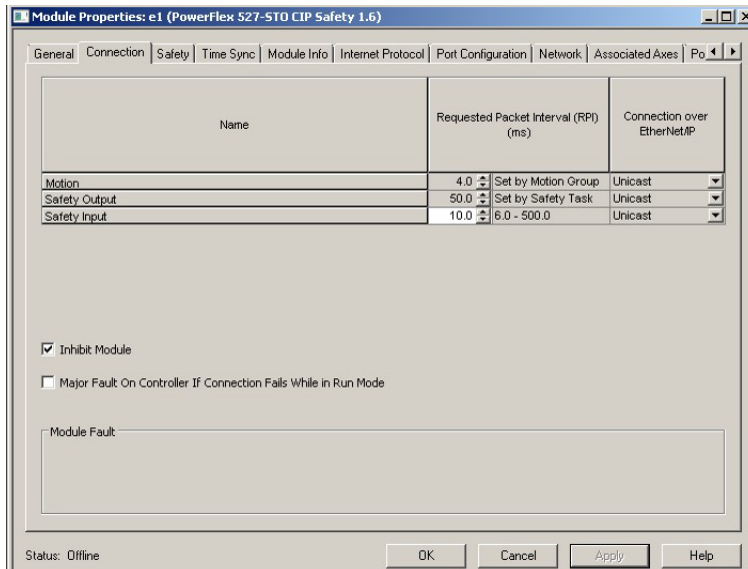

2. Check Inhibit Module.
3. Click Apply, then click the Safety tab.

The Safety tab appears.

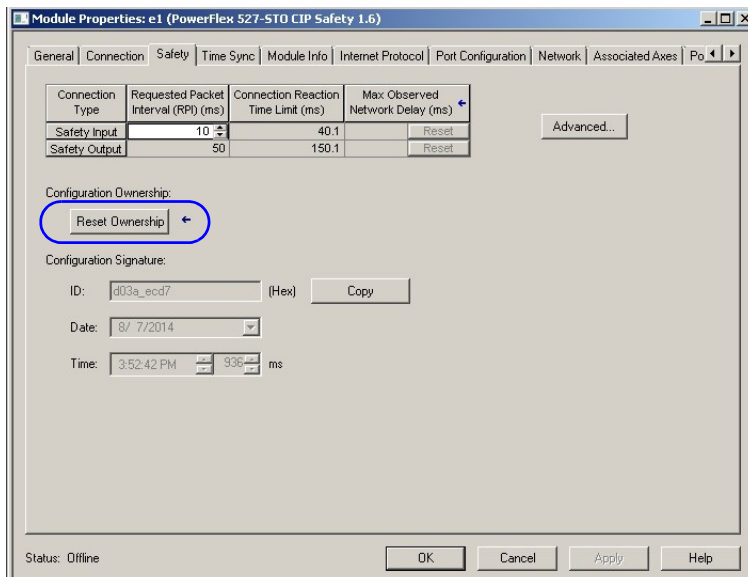

4. In the Configuration Ownership field, click Reset Ownership.

**IMPORTANT** Only authorized personnel should attempt Reset Ownership.

The safety connection must be inhibited before the reset is attempted. If any active connection to the drive is detected, the reset is rejected.

5. Cycle drive power.

The drive is in the out-of-box state.

---

**IMPORTANT** If power to the drive is not cycled after [step 4](#), the drive does not transition to the out-of-box state and maintains STO function.

---

**IMPORTANT** When the drive returns to the out-of-box state, the STO function reverts to hardwired control.

---

- On power-up, make sure that the drive does not have a safety connection.

## Safe Torque-Off Status

This section describes the safety-related status that is available to the motion controller.



**ATTENTION:** The status data described in this section is STANDARD data (not SAFETY data) and may not be used as part of a safety function.

### Axis Tags

When a PowerFlex 527 Add-On-Profile (AOP) is added to a Logix I/O tree, Axis tags are added to the controller tags.

[Table 8](#) lists the safety-related STANDARD tags that are added when a new AXIS\_CIP\_DRIVE axis is defined.

**Table 8 - Safety-Related Axis Tags**

Logix Designer Tag Name	Attribute [bit]	Type	Description
AxisFault	<b>34</b>	DINT	
GuardFaultStatus	[5]	BOOL	STO Fault - Hardwired
SafetyFaultStatus	[8]	BOOL	STO Fault - Network
GuardStatus <sup>(1)</sup>	<b>980</b>	DINT	
GuardOKStatus	[0]	BOOL	Not STO Fault - Hardwired
GuardGateDriveOutputStatus	[2]	BOOL	Torque Permitted - Hardwired
GuardStopInputStatus	[3]	BOOL	Safety Inputs Enabled
GuardStopRequestStatus	[4]	BOOL	Torque Disabled - Hardwired
GuardFault <sup>(1)</sup>	<b>981</b>	DINT	
GuardStopInputFault	[9]	BOOL	STO Fault - Hardwired
GuardGateDriveFault	[2]	BOOL	Internal STO Circuit Fault - Hardwired
CIPAxisFaultsRA	<b>903</b>	LINT	
SafetyModuleCommunicationErrorFault	[28]	BOOL	Loss of communications to Safety Control
CIPAxisAlarmsRA	<b>904</b>	LINT	
SafetyModuleCommunicationErrorAlarm	[28]	BOOL	Loss of communications to Safety Control
CIPInitializationFaultsRA	<b>910</b>	DINT	
InvalidSafetyFirmwareFault	[14]	BOOL	Invalid Safety Control Firmware
CIPStartInhibits	<b>676</b>	INT	
SafeTorqueOffActiveInhibit	[5]	BOOL	Torque Disabled - Network
CIPStartInhibitsRA	<b>912</b>	INT	
SafeTorqueOffInhibit	[5]	BOOL	Torque Disabled - Hardwired
AxisSafetyState	<b>760</b>	INT	Safety Supervisor State
AxisSafetyStatus <sup>(1)</sup>	<b>761</b>	DINT	
SafetyFaultStatus	[0]	BOOL	Status of SI.SafetyFault
SafetyResetRequestStatus	[1]	BOOL	Status of SO.ResetRequest
SafetyResetRequiredStatus	[2]	BOOL	Status of SI.ResetRequired
SafeTorqueOffActiveStatus	[3]	BOOL	Status of SO.SafeTorqueOff

Table 8 - Safety-Related Axis Tags (Continued)

Logix Designer Tag Name	Attribute [bit]	Type	Description
SafeTorqueDisabledStatus	[4]	BOOL	Status of SI.TorqueDisabled
SafetyOutputConnectionClosed	[30]	BOOL	1 if all output connections are closed
SafetyOutputConnectionIdleStatus	[31]	BOOL	1 if output controller is in program mode
AxisSafetyFaults <sup>(1)</sup>	<b>763</b>	DINT	
SafetyCoreFault	[1]	BOOL	Loss of communications to Safety Control
SafeTorqueOffFault	[3]	BOOL	Status of SI.SafetyFault

(1) Bits not shown are always zero.

## Explicit Messages

Explicit messages can be used to obtain additional diagnostic information from the safety control using a MSG instruction.

### Safety Supervisor State

The Safety Supervisor State provides information on the state of the CIP Safety connection and the mode of operation.

#### Safety Supervisor State: MSG

Parameter	Value	Description
Service Code	0x0E	Get Attribute Single
Class	0x39	Safety Supervisor
Instance	1	—
Attribute	0x0B	Device Status
Data Type	SINT	Unsigned Short Integer

#### Safety Supervisor State: Values

Value	Definition	Definition	Mode
2	Idle	No Active Connections	Network
4	Executing	Normal Running State	Network
7	Configuring	Transition State	Network
8	Waiting for TUNID	Out-of-Box State	Hardwired
51	Waiting for TUNID with Torque Permitted	Out-of-Box State	Hardwired
52	Executing with Torque Permitted	STO Bypass State	Network

### Propose TUNID Blocked

The attribute Propose TUNID Blocked can be used to check if the drive is in a state where it will accept a safety connection. If the drive is enabled, it will not accept a safety connection.

#### Propose TUNID Blocked: MSG

Parameter	Value	Description
Service Code	0x0E	Get Attribute Single
Class	0x5A	Safety Stop Functions
Instance	0	Class Attribute
Attribute	0x65	STO Mode
Data Type	SINT	Unsigned Short Integer



**Safe Torque-Off Mode: Values**

Value	Definition
0	Accept a Safety Connection
1	Block a Safety Connection

**Safe Torque-Off Mode**

The attribute STO Mode can be used to check if the PowerFlex 527 is in STO Bypass Mode.

**Safe Torque-Off Mode: MSG**

Parameter	Value	Description
Service Code	0x0E	Get Attribute Single
Class	0x5A	Safety Stop Functions
Instance	1	Axis Number
Attribute	0x104	STO Mode
Data Type	SINT	Unsigned Short Integer

**Safe Torque-Off Mode: Values**

Value	Definition
1	Normal Operation
2	STO Bypass Mode

**Safe Torque-Off Faults**

When a safety fault is indicated in any of the following tags:

- SI.SafetyFault
- Axis.SafetyFaultStatus
- Axis.SafetyTorqueOffFault

The cause of the fault can be read using an explicit message.

**Safe Torque-Off Fault Type: MSG**

Parameter	Value	Description
Service Code	0x0E	Get Attribute Single
Class	0x5A	Safety Stop Functions
Instance	1	Axis Number
Attribute	0x108	STO Fault Type
Data Type	SINT	Unsigned Short Integer

**Safe Torque-Off Fault Type: Values**

Value	Definition
1	No Fault
3	Circuit Error
102	Hardwired Input Discrepancy
104	Hardwired Input in Network Mode

## Hardwired Control of Safe Torque-Off

This chapter introduces you to how the PowerFlex 527 integrated safe torque-off feature is configured for hardwired control of safe torque-off.

Topic	Pages
Description of Operation	93
Safe Torque-Off Connector Data	96
Wire the Safe Torque-Off Circuit	96
Safe Torque-Off Specifications	97

### Description of Operation

The safe torque-off feature provides a method, with sufficiently low probability of failure, to force the power-transistor control signals to a disabled state. If either hardwired safety input is de-energized, all drive output-power transistors are released from the On state. This results in a condition where the drive is coasting (stop category 0). Disabling the power transistor output does not provide mechanical isolation of the electrical output that is required for some applications.

### Selection of Hardwired Safe Torque-Off

To select hardwired control of safe torque-off (STO):

- The safety control must be in the out-of-box state.
- The Safety Bypass Jumper must be removed.
- An appropriate safety device must be connected to terminals S1, S2, and o1 (Digital Common).

### Operation of Hardwired Safe Torque-Off

Under normal operation, the safe torque-off inputs are energized. If either of the safety enable inputs are de-energized, then all output power transistors turn off. The safe torque-off response time is less than 12 ms.



**ATTENTION:** If any of the safety enable inputs de-energize, the Start Inhibit field indicates SafeTorqueOffInhibit and the GuardStopRequestStatus bit of the axis GuardStatus tag are set to 1. Both inputs must be de-energized within 1 second and re-energized within 1 second to avoid GuardStopInputFault conditions.

System Operation when Inputs are Meeting Timing Requirements

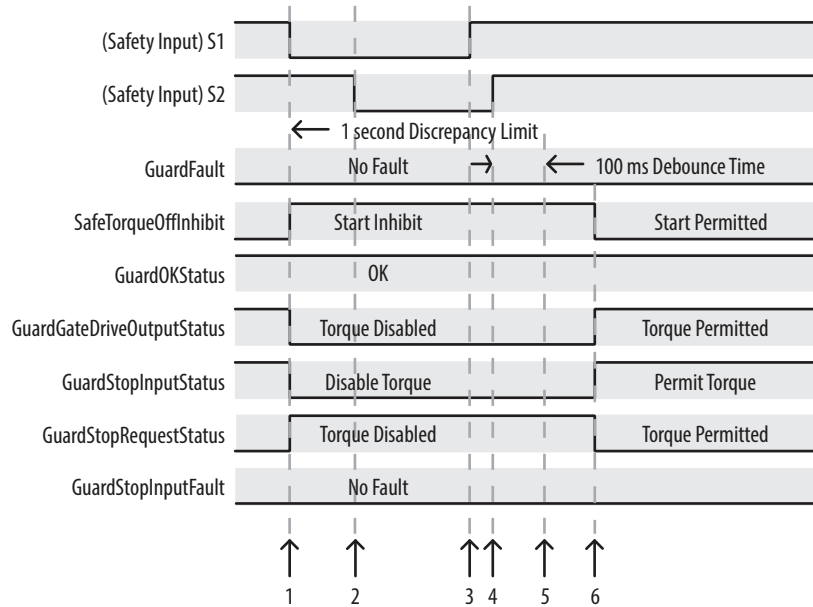

Event	Description
1	At least one input is switched off. GuardStopRequestStatus bit is set to 1.
2	Second input is switched off within 1 second. This must always occur within 1 second to help prevent a GuardStopInputFault condition.
3	First input is switched on.
4	Second input is switched on within 1 second of event 3.
5	Both inputs are in the ON state simultaneously within 1 second. As a result, the GuardStopInputFault is not posted.
6	The GuardStopRequestStatus bit is set back to 0 if both inputs are in the ON state for 100 ms continuously (100 ms debounce time).

Troubleshoot the Safe Torque-Off Function

PowerFlex 527 Drive Troubleshooting

Exception Code on Drive Display	Fault Message Logix Designer	Problem	Possible Solutions
SAFE FLT 09 - SS IN	GuardStopInputFault	Safe torque-off function mismatch. System does not allow motion. Safe torque-off mismatch is detected when safety inputs are in a different state for more than 1.0 second.	<ul style="list-style-type: none"> <li>Verify safety wiring and connections:                             <ul style="list-style-type: none"> <li>Wire terminations at safe torque-off (STO) connector</li> <li>Cable/header not seated correctly</li> <li>+24V power</li> </ul> </li> <li>Check state of safety inputs.</li> <li>Reset error and run proof test.</li> <li>Return drive for repair if fault continues.</li> </ul>
SAFE FLT 01 - GUARD INTERNALFAULT	CPUWatchdogFault <sup>(1)</sup>	Drive safety diagnostic detected internal STO design failure.	<ul style="list-style-type: none"> <li>Cycle power.</li> <li>Return drive for repair if fault continues.</li> </ul>
SAFE FLT 03 - GUARD GATE DRIVE FAULT	SafeTorqueOffFault <sup>(2)</sup>	Drive safety diagnostic detected internal STO design failure.	<ul style="list-style-type: none"> <li>Cycle power.</li> <li>Execute STO function.</li> <li>Return drive for repair if fault continues.</li> </ul>
		Hardwired safe torque off input energized when drive is in network safety mode.	Reset the drive to out-of-box settings, hardwired safety mode. See <a href="#">Restoring the Drive to the Out-of-Box State on page 88</a> for instructions.

(1) Displayed in the LCD display as Module Fault.  
 (2) Displayed in the LCD display as Safety Fault.

[Figure 1](#) demonstrates when the safe torque-off mismatch is detected and a GuardStopInputFault is posted.

**Figure 1 - System Operation in the Event that the Safety Enable Inputs Mismatch**

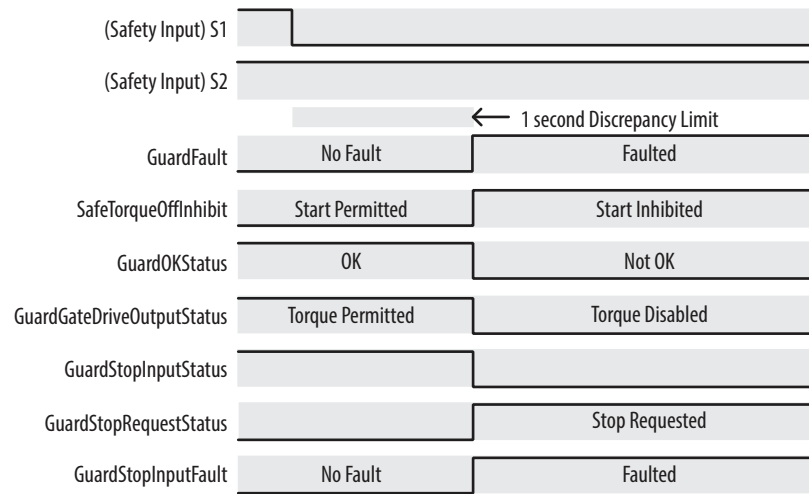

When one safety input is turned off, the second input must also be turned off, otherwise a fault is asserted (See [Figure 2 on page 95](#)). The fault is asserted even if the first safety input is turned on again.

**Figure 2 - System Operation in the Event that the Safety Enable Inputs Mismatch Momentarily**

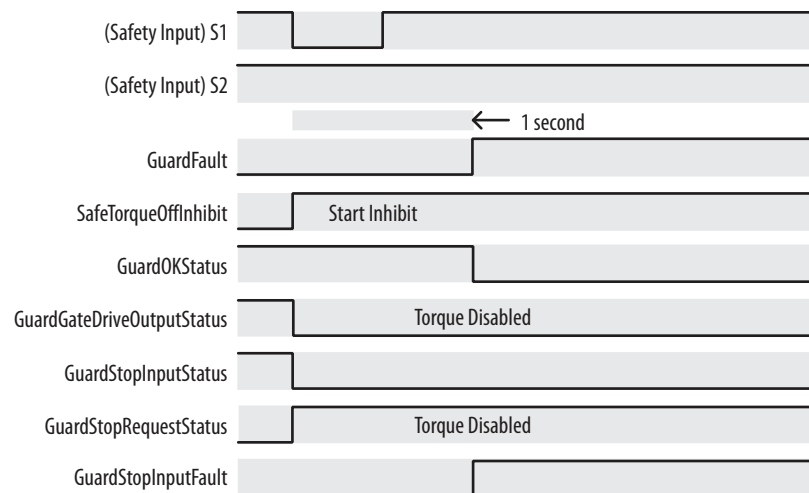

**ATTENTION:** The safe torque-off fault is detected upon demand of the safe torque-off function. After troubleshooting, a safety function must be executed to verify correct operation.

**IMPORTANT**

The Safe Torque-Off fault can be reset only if both inputs are in the Off state for more than 1 second. After the fault reset requirement is satisfied, an MASR command in the Logix Designer application must be issued to reset the GuardFault and GuardStopInputFault conditions.

## Safe Torque-Off Connector Data

PowerFlex 527 terminals S1, S2, and S+ are used for hardwired control of safe torque-off.

### Terminals for Safe Torque-Off (STO) Connection

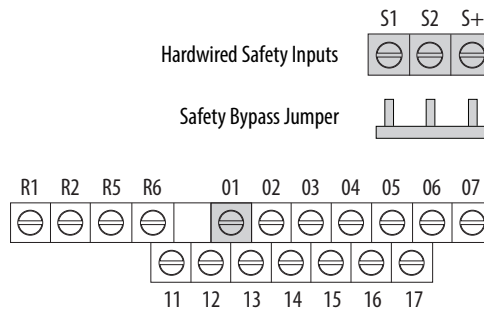

### Safe Torque-Off (STO) Connector Pinouts Control

STO Pin	Signal	Description
01	Digital Common	The return for digital I/O. It is electrically isolated (along with the digital inputs and encoder power) from the rest of the drive.
S1	Safety 1	Safety input 1.
S2	Safety 2	Safety input 2.
S+	Safety +24V	+24V supply for safety circuit. This is internally tied to the +24V DC source (terminal 11).

**IMPORTANT** Digital Common (terminal 01) is common for the digital inputs, the safety inputs, and the encoder power supply (optional).

## Wire the Safe Torque-Off Circuit

This section provides guidelines for wiring safe torque-off connections to your PowerFlex 527 drive.

**IMPORTANT** The National Electrical Code and local electrical codes take precedence over the values and methods provided.

**IMPORTANT** Pin S+ (Safety +24V) is used to disable the safe torque-off function. When wiring to the STO connector, use an external 24V supply for the external safety device that triggers the safe torque-off request. To avoid jeopardizing system performance, do not use pin S+ as a power supply for the external safety device.

### Safe Torque-Off Wiring Requirements

The safe torque-off (STO) connection wire must be copper with 75 °C (167 °F) minimum rating.

**IMPORTANT** The National Electrical Code and local electrical codes take precedence over the values and methods provided.

**IMPORTANT** Stranded wires must terminate with ferrules to help prevent short circuits, per table D.7 of EN ISO 13849-2.

### Safe Torque-Off (STO) Terminal Wiring

Maximum Wire Size <sup>(1)</sup>	Minimum Wire Size <sup>(1)</sup>	Torque
1.3 mm <sup>2</sup> (16 AWG)	0.13 mm <sup>2</sup> (26 AWG)	0.71...0.86 N•m (6.2...7.6 lb•in)

(1) Maximum and minimum sizes that the terminal block will accept. These are not recommended wire sizes.

## Safe Torque-Off Specifications

To maintain their safety rating, PowerFlex 527 drives must be installed inside protected control panels or cabinets appropriate for the environmental conditions of the industrial location. The protection class of the panel or cabinet must be IP54 or higher.

### Safe Torque-Off Signal Specifications

Attribute		Value
Safety inputs (per channel)	Input current	< 10 mA
	Input ON voltage, max	18...26.4V DC
	Input OFF voltage, max	5V DC
	Input ON current	10 mA
	Input OFF current	500 $\mu$ A
	Pulse rejection width	700 $\mu$ s
	External power supply	SELV/PELV
	Input type	Optically isolated and reverse voltage protected

**Notes:**

## Network Control of Safe Torque-Off

This chapter describes network control of the safe torque-off function. This example uses a 1756-L7xS GuardLogix safety controller to issue the safe torque-off (STO) command over the EtherNet/IP network and the PowerFlex 527 drive executes the STO command.

Topic	Page
Understanding Integrated Safety Drive Replacement	103
Replacing an Integrated Safety Drive in a GuardLogix System	103
Motion Direct Commands in Motion Control Systems	109
Functional Safety Considerations	114

### Compatible Safety Controllers

The Studio 5000 Logix Designer application:

- Version 24.00 or later, provides support for programming, commissioning, and maintaining the 1756-L7xS GuardLogix safety controller.
- Version 28.00 or later, provides support for programming, commissioning, and maintaining the Compact GuardLogix 5370 safety controller.

A 1756-L7xS GuardLogix or Compact GuardLogix 5370 safety controller is required for network control of the PowerFlex 527 safe torque-off function.

The PowerFlex 527 safety connection can originate from a safety controller that provides both safety and motion control.

The PowerFlex 527 safety connection can originate from a safety controller that controls only the safety, while a separate Logix processor controls motion.

### Selection of Network Safe Torque-Off

To select network control of safe torque-off:

1. The PowerFlex 527 drive must be added to a 1756-EN2T, 1756-EN2TR, 1756-EN2F, 1756-EN3T, or 1756-EN3TR EtherNet/IP bridge in a 1756-L7xS GuardLogix controller I/O tree.
2. The 1756-EN2T, 1756-EN2TR, 1756-EN2F, 1756-EN3T, or 1756-EN3TR EtherNet/IP bridge must be configured for “Safety Only” or “Motion and Safety”.
3. Download the new configuration to the controller.  
The drive display may show fault code “SAFE FLT 03 - GUARD GATE DRIVE FAULT”.
4. Turn off incoming power to the drive.



5. Remove the Safety Bypass jumper.
6. Turn on incoming power to the drive.  
Any display fault should now be cleared.

## Safety Application Requirements

Creating, recording, and verifying the safety signature is also a required part of the safety application development process. Safety signatures are created by the safety controller. The safety signature consists of an identification number, date, and time that uniquely identifies the safety portion of a project. This signature covers all safety logic, data, and safety I/O configuration.

For safety system requirements, including information on the safety network number (SNN), verifying the safety signature, and functional verification tests, see the GuardLogix 5570 and Compact GuardLogix 5370 Reference Manual, publication [1756-RM099](#).

---

**IMPORTANT** You must read, understand, and fulfill the requirements that are detailed in this publication before operating a safety system that uses a GuardLogix controller and PowerFlex 527 drive.

---

## Network Safe Torque-off Specifications

### Safe Torque-off Network Specifications

Attribute	Value
Safety connection RPI, minimum	6 ms
Input assembly connections	1
Output assembly connections	1
Integrated safety open request support	Type 1 and Type 2 requests

### Safe Torque-off Assembly Tags

With network control, a 1756-L7xS GuardLogix safety controller controls the PowerFlex STO function through the SO.SafeTorqueOff tag in the safety output assembly.

The SO.Command tags are sent from the GuardLogix safety output assembly to the PowerFlex 527 to control the safe torque-off function.

The SI.Status tags are sent from the PowerFlex 527 to the GuardLogix safety input assembly and indicate the PowerFlex 527 safety control status.

The SI.ConnectionStatus tags indicate the status of the safety input connection.

[Table 9 on page 101](#) lists the SAFETY tags added to the controller tags when a PowerFlex 527 drive is added to a GuardLogix I/O configuration and the connection is configured for “Motion and Safety” or for “Safety only”.

The “Attribute” values that are listed are the Assembly Object attribute values.

**Table 9 - Safe Torque-off Assembly Tags**

Logix Designer Tag Name	Attribute [bit]	Type	Description
SI.ConnectionStatus <sup>(1)(2)</sup>		DINT	
SI.RunMode	[0]	BOOL	See <a href="#">Table 10</a> .
SI.ConnectionFaulted	[1]	BOOL	
SI.Status <sup>(1)(3)</sup>	<b>0x1A0</b>	SINT	
SI.TorqueDisabled	[0]	BOOL	0 = Torque Permitted; 1 = Torque Disabled
SI.SafetyFault	[6]	BOOL	1 = STO Fault present
SI.ResetRequired	[7]	BOOL	1 = A reset is required
SO.Command <sup>(1)(4)</sup>	<b>0x180</b>	SINT	
SO.SafeTorqueOff	[0]	BOOL	0 = Disable Permit; 1 = Permit Torque
SO.Reset	[7]	BOOL	0→1 = Reset STO Fault

(1) Bits not listed are always zero.

(2) ConnectionStatus is determined by the Safety Validator in the GuardLogix controller. For more information, see the Safety Connection Status table in the GuardLogix 5570 and Compact GuardLogix 5370 Reference Manual, publication [1756-RM099](#).

(3) The Status is sent from the drive to the controller using the CIP Safety protocol.

(4) The Command is sent from the controller to the drive using the CIP Safety protocol.



**ATTENTION:** Only data that is listed in [Table 10](#) is SAFETY data with SIL 3 integrity.

**Table 10 - Safety Connection Status**

RunMode Status	ConnectionFaulted Status	Safety Connection Operation
1 = Run	0 = Valid	Data is actively being controlled by the producing device. The producing device is in Run mode.
0 = Idle	0 = Valid	The connection is active and the producing device is in the Idle state. The safety data is reset to zero.
0 = Idle	1 = Faulted	The safety connection is faulted. The state of the producing device is unknown. The safety data is reset to zero.
1	1	Invalid state.

## STO Fault Reset

If a PowerFlex 527 drive safety control detects a fault, the input assembly tag SI.SafetyFault is set to 1. A transition from logic 0 to 1 of the SO.Reset tag is required after the SO.SafeTorqueOff tag has transitioned from logic 0 to 1.

To reset Axis.SafetyFault, a MAFR command must be issued.

**IMPORTANT** Transition of the SO.SafeTorqueOff tag to logic 1 must always be executed before transition of the SO.Reset tag to logic 1.

**IMPORTANT** PowerFlex 527 drives enter the STO Fault state if any STO function fault is detected. See [Table 11 on page 102](#) for integrated safety troubleshooting.

**IMPORTANT** An STO Fault sets the Axis.SafetyFault tag. After the STO Fault is reset, a MAFR command must be issued by the motion controller to clear the Axis.SafetyFault tag to enable motion.

See [Figure 3 on page 102](#) for an understanding of the PowerFlex 527 STO Fault reset functionality.

Figure 3 - Reset Safe Torque-Off Fault Diagram

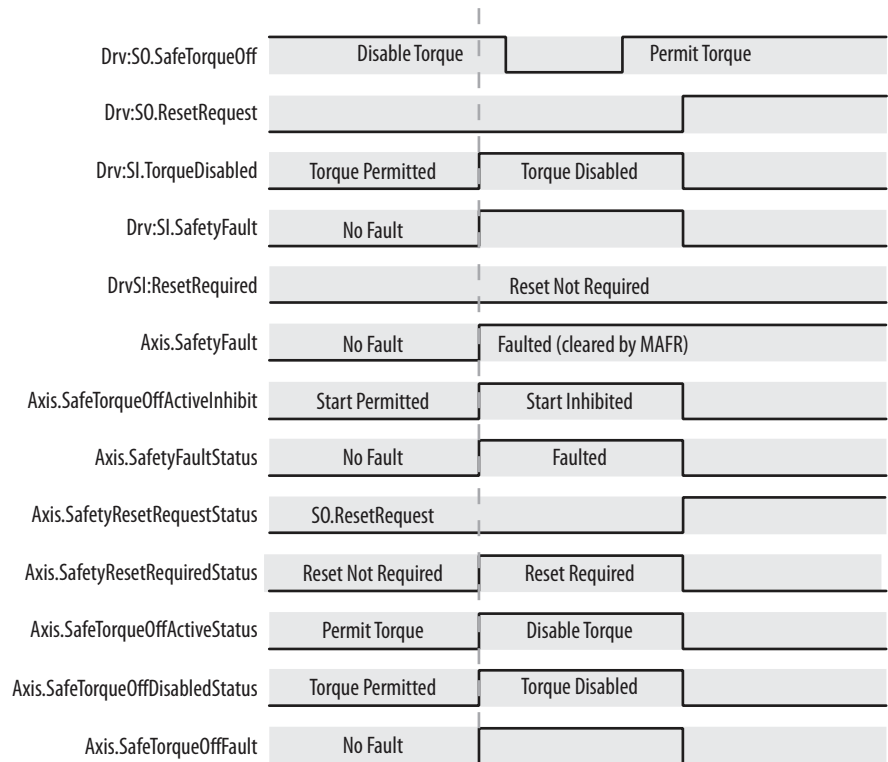

### Troubleshoot Network Safe Torque-Off

Table 11 - PowerFlex 527 Drive Troubleshooting

Exception Code on Drive Display	Fault Message Logix Designer	Problem	Possible Solutions
SAFE FLT 01 - GUARD INTERNAL FAULT	CPUWatchDogFault <sup>(1)</sup>	Drive safety diagnostic detected internal STO design failure.	<ul style="list-style-type: none"> <li>• Cycle power.</li> <li>• Return drive for repair if fault continues.</li> </ul>
FLT AXIS FLT M28 - SAFETY COMM	SafetyModuleCommunicationErrorFault <sup>(1)</sup>	Drive safety diagnostic detected internal STO design failure.	<ul style="list-style-type: none"> <li>• Cycle power.</li> <li>• Return drive for repair if fault continues.</li> </ul>
SAFE FLT 03 - GUARD GATE DRIVE FAULT (STO Fault Type = 3)	SafeTorqueOffFault <sup>(2)</sup>	Drive safety diagnostic detected internal STO design failure	<ul style="list-style-type: none"> <li>• Cycle power.</li> <li>• Execute STO function.</li> <li>• Return drive for repair if fault continues.</li> </ul>
SAFE FLT 03 - GUARD GATE DRIVE FAULT (STO Fault Type = 104)	SafeTorqueOffFault <sup>(2)</sup>	Hardwired input energized in network mode.	<ul style="list-style-type: none"> <li>• Remove power.</li> <li>• Remove any connection to hardwired safety inputs.</li> <li>• Restore power.</li> </ul>
INIT FLT M14 - INVALID SAFETY FIRMWARE	InvalidSafetyFirmwareFault <sup>(2)</sup>	The safety firmware is not compatible with the drive firmware, or the main safety firmware is missing.	<ul style="list-style-type: none"> <li>• Cycle power.</li> <li>• Upgrade drive firmware.</li> <li>• Return drive for repair if fault continues.</li> </ul>

(1) Displayed in the LCD display as Module Fault.  
 (2) Displayed in the LCD display as Safety Fault.

## Understanding Integrated Safety Drive Replacement

GuardLogix controllers retain I/O device configuration onboard and are able to download the configuration to the replacement device.

**IMPORTANT** If the replacement PowerFlex 527 drive was used previously, clear its existing configuration before installing it on a safety network by resetting the drive to its out-of-box condition. To see how this is done, see [Out-of-Box \(OOB\) Safety State on page 88](#).

Replacing a PowerFlex 527 drive that sits on an integrated safety network is more complicated than replacing standard devices because of the Safety Network Number (SNN). The device number and SNN make up the safety device's DeviceID. Safety devices require this more complex identifier to make sure that duplicate device numbers do not compromise communication between the correct safety devices. The SNN is also used to provide integrity on the initial download to the PowerFlex 527 drive.

When the Logix Designer application is online, the Safety tab of the Module Properties dialog box displays the current configuration ownership. When the opened project owns the configuration, Local is displayed.

Configuration Ownership: Local

A communication error is displayed if the module read fails. See [Replacing an Integrated Safety Drive in a GuardLogix System](#) for integrated safety drive replacement examples.

## Replacing an Integrated Safety Drive in a GuardLogix System

If you are relying on a portion of the integrated safety system to maintain SIL 3 behavior during drive replacement and functional testing, do not use the Configure Always feature.

Use the Configure Always feature when you are not relying on the entire routable integrated safety control system to maintain PLe/SIL 3 behavior during the replacement and functional testing of a PowerFlex 527 drive. Drive replacement is configured on the Safety tab of the GuardLogix controller.

### Setting the SNN with a GuardLogix Controller

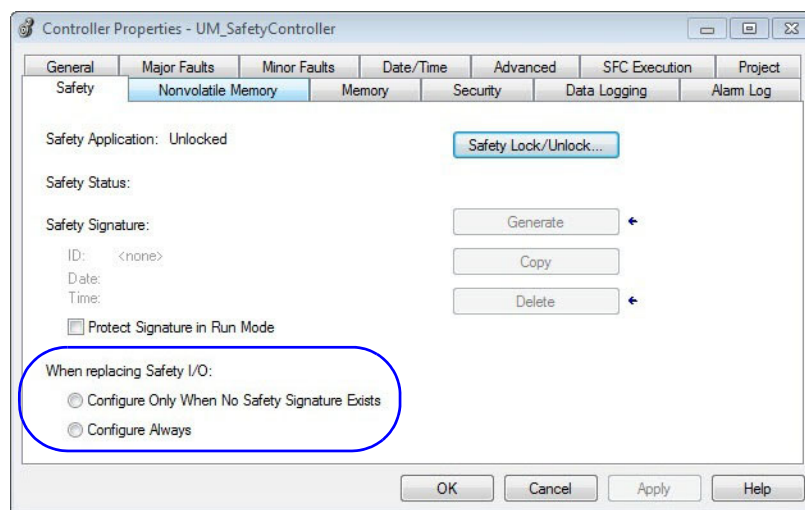

## Replacement with “Configure Only When No Safety Signature Exists” Enabled

When a PowerFlex 527 drive is replaced and the DeviceID of the new drive matches the original, you can download the configuration from the safety controller. The DeviceID is a combination of the node/IP address and the safety network number (SNN), and is updated whenever the SNN is set.

If the project is configured as Configure Only When No Safety Signature Exists, follow the appropriate instructions in [Table 12](#) to replace a PowerFlex 527 drive based on your scenario. Once you have completed the steps correctly and the DeviceID matches the original, the safety controller can download the proper drive configuration and re-establish the safety connection.

**Table 12 - Replacing a PowerFlex 527 Drive**

GuardLogix Safety Signature Exists	GuardLogix Safety Signature Exists	Action Required
No	No SNN (out-of-box)	None. The module is ready for use.
Yes or No	Same SNN as original safety task configuration	
Yes	No SNN (out-of-box)	See Scenario 1 on <a href="#">page 104</a> .
Yes	Different SNN than original safety task configuration	See Scenario 2 on <a href="#">page 106</a> .
No		See Scenario 3 on <a href="#">page 108</a> .

### Scenario 1 - Replacement Integrated Safety Drive Is Out-of-Box and Safety Signature Exists

1. Remove and replace the existing integrated safety drive.
2. Right-click the replacement drive and choose Properties.  
The General tab appears in the Module Properties dialog box.

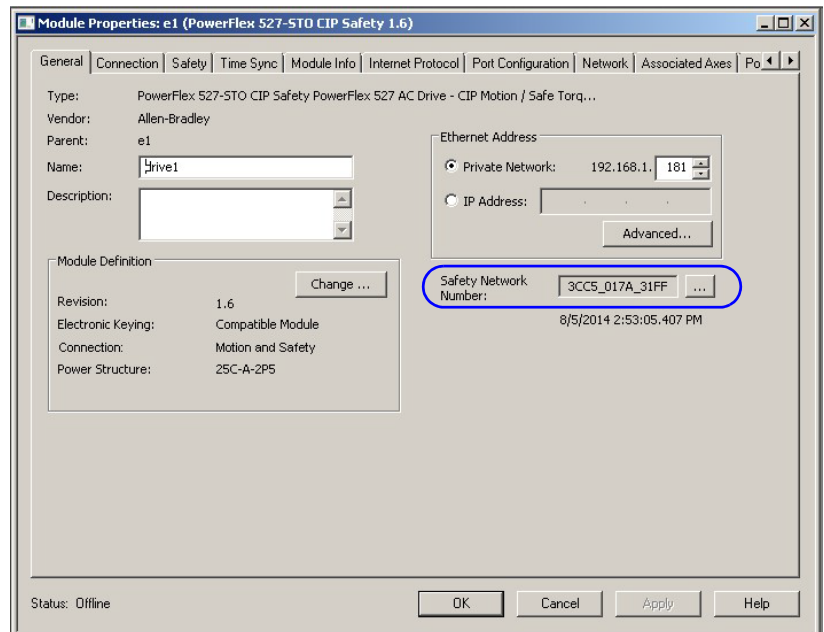

- Click  to the right of the Safety Network Number (SNN). The Safety Network Number dialog box appears.

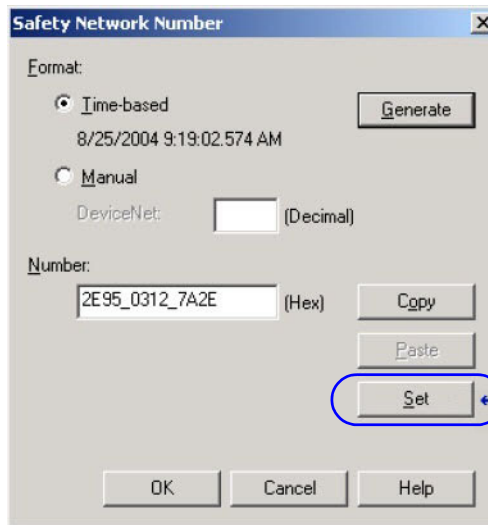

- Click Set.
- Verify that the Network Status (NET) status indicator is alternating red/green on the correct drive.

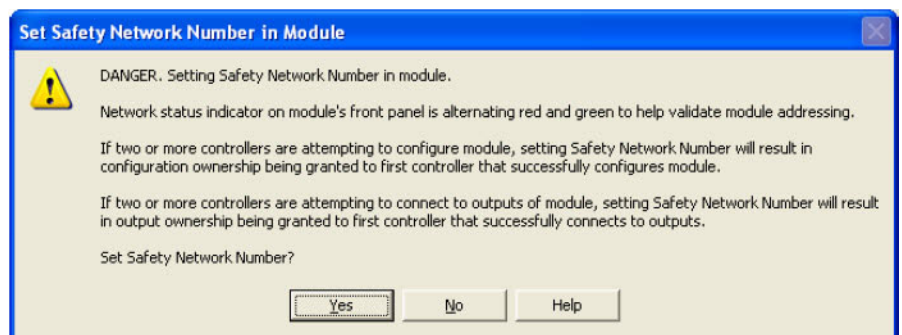

- Click Yes to set the SNN and accept the replacement drive.
- Power cycle the drive.
- Follow your company-prescribed procedures to functionally test the replacement drive and system and to authorize the system for use.

*Scenario 2 - Replacement Integrated Safety Drive SNN is Different from Original and Safety Signature Exists*

1. Remove and replace the existing integrated safety drive.
2. Right-click the replacement drive and choose Properties.
3. Click the Safety tab.

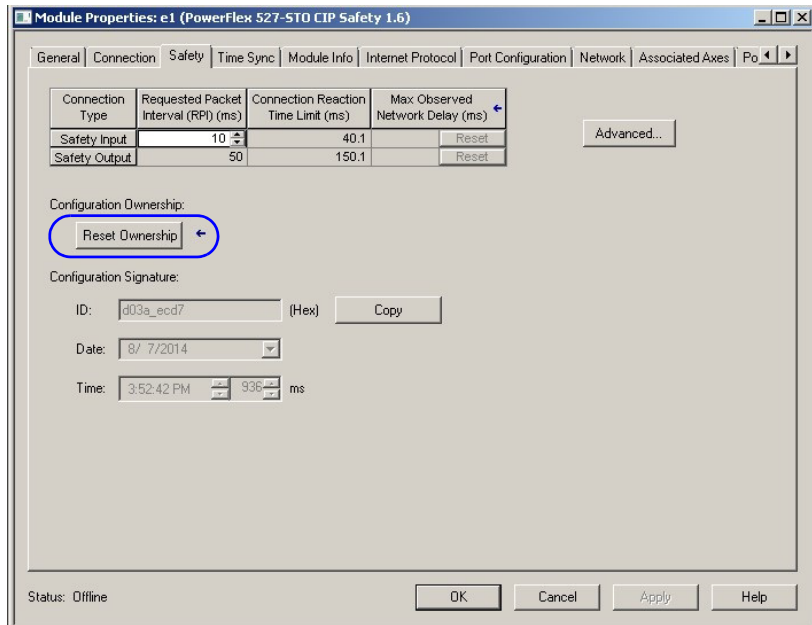

4. Click Reset Ownership.
5. Click OK.
6. Right-click the replacement drive and chooses Properties. The General tab appears in the Module Properties dialog box.

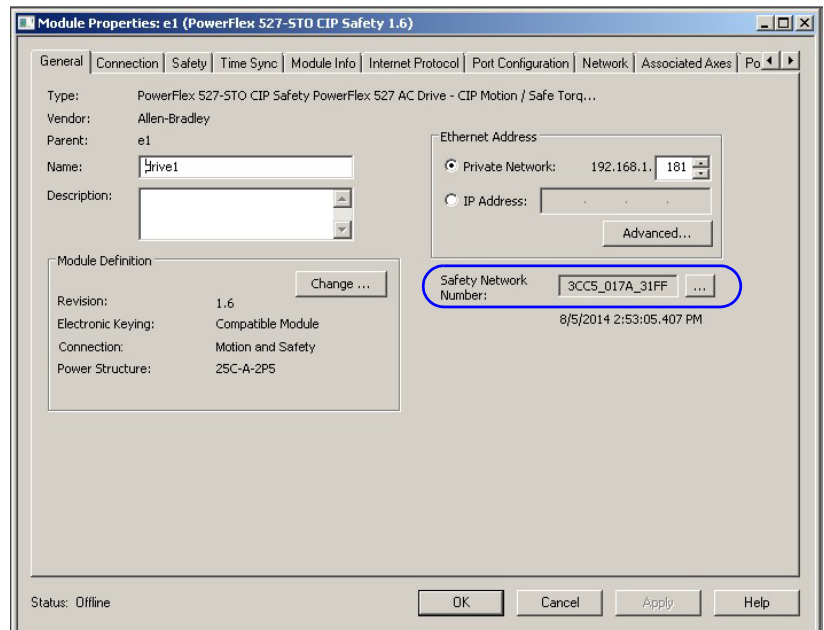

7. Click  to the right of the Safety Network Number (SNN). The Safety Network Number dialog box appears.

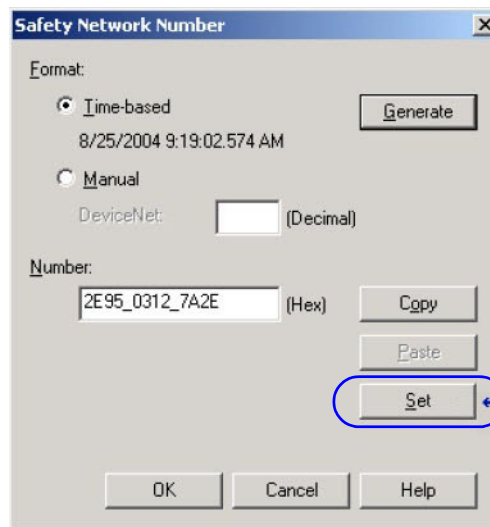

8. Click Set.
9. Verify that the Network Status (NET) status indicator is alternating red/green on the correct drive.

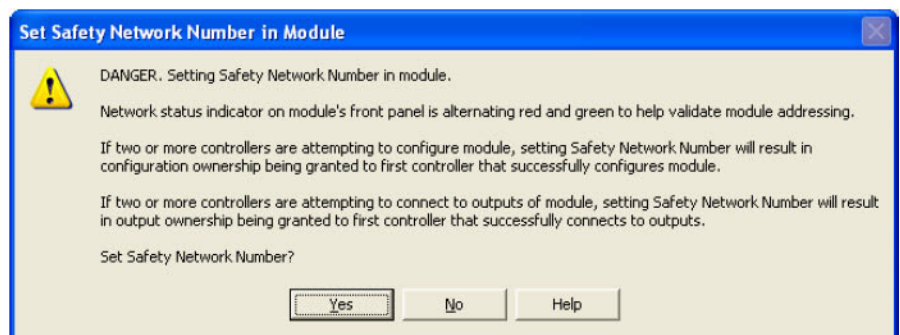

10. Power cycle the drive.
11. Follow your company-prescribed procedures to functionally test the replacement drive and system and to authorize the system for use.



### Scenario 3 – Replacement Integrated Safety Drive SNN is Different from Original and no Safety Signature Exists

1. Remove and replace the existing integrated safety drive.
2. Right-click the replacement drive and choose Properties.
3. Click the Safety tab.

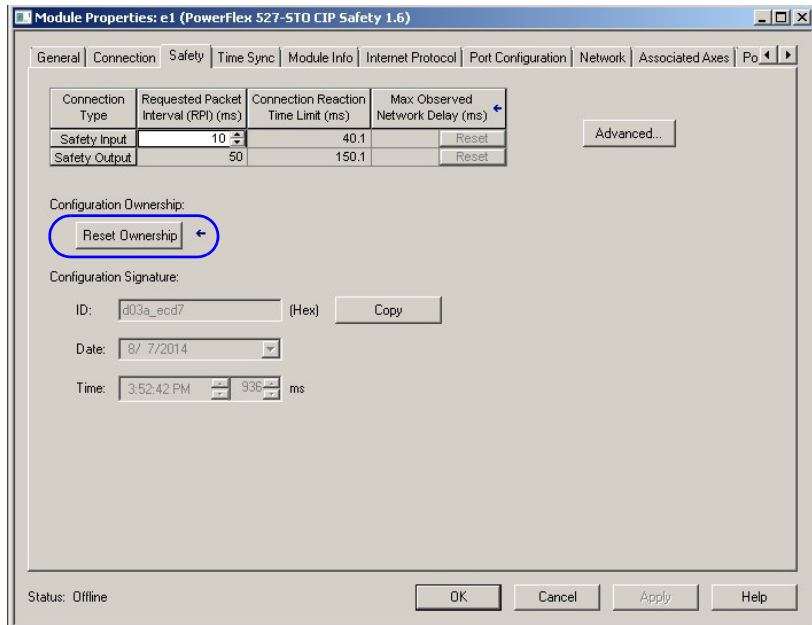

4. Click Reset Ownership.
5. Click OK.
6. Power cycle the drive.
7. Follow your company-prescribed procedures to functionally test the replacement drive and system and to authorize the system for use.

## Replacement with “Configure Always” Enabled



**ATTENTION:** Enable the Configure Always feature only if the entire integrated safety control system is not being relied on to maintain SIL 3 behavior during the replacement and functional testing of a PowerFlex 527 drive. Do not place drives that are in the Out-of-box condition on an integrated safety network when the Configure Always feature is enabled, except while following this replacement procedure.

When the Configure Always feature is enabled, the controller automatically checks for and connects to a replacement drive that meets all the following requirements:

- The controller has configuration data for a compatible drive at that network address.
- The drive is in the Out-of-box condition or has an SNN that matches the configuration.

If the project is configured for Configure Always, follow the appropriate steps to replace a PowerFlex 527 drive.

Follow these steps when the Configure Always feature is enabled.

1. Remove and replace the existing integrated safety drive.

If	Then
The drive is in the Out-of-box condition	Go to step 6. No action is needed for the GuardLogix controller to take ownership of the drive.
An SNN mismatch error occurs	Go to the next step to reset the drive to the Out-of-box condition.

2. Right-click the replacement drive and choose Properties.
3. Click the Safety tab.

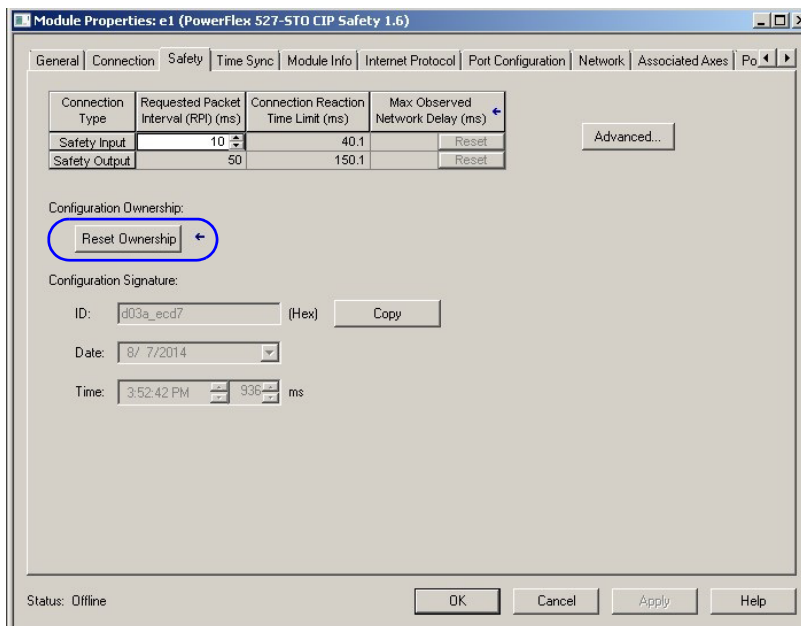

4. Click Reset Ownership.
5. Click OK.
6. Follow your company-prescribed procedures to functionally test the replacement drive and system and to authorize the system for use.

## Motion Direct Commands in Motion Control Systems

You can use the Motion Direct Command (MDC) feature to initiate motion while the controller is in Program mode, independent of application code that is executed in Run mode. These commands let you perform a variety of functions, for example, move an axis, jog an axis, or home an axis. See the Logix 5000 Controllers Motion Instructions Reference Manual, publication [MOTION-RM002](#) for more information.

A typical use might involve a machine integrator testing different parts of the motion system while the machine is being commissioned, or a maintenance engineer, under certain restricted scenarios in accordance with safe machine operating procedures, wanting to move an axis (like a conveyor) to clear a jam before resuming normal operation.



**ATTENTION:** To avoid personal injury or damage to equipment, follow these rules regarding Run mode and Program mode.

- Only authorized, trained personnel with knowledge of safe machine operation should be allowed to use Motion Direct Commands.
- Additional supervisory methods, like removing the controller keyswitch, should be used to maintain the safety integrity of the system after returning the safety controller to RUN mode.

## Understanding STO Bypass When Using Motion Direct Commands

If a Safety-only connection between the GuardLogix safety controller and the PowerFlex 527 drive was established at least once after the drive was received from the factory, the drive does not allow motion while the safety controller is in Program mode by default.

This is because the safety task is not executed while the GuardLogix safety controller is in Program mode. This applies to applications running in a single safety controller (with Motion and Safety connections). When an integrated safety drive has a Motion connection to a standard controller and a separate Safety connection to a dual-safety controller, the standard controller can transition to Program mode while the safety controller stays in Run mode and continues to execute the safety task.

However, PowerFlex 527 drive systems are designed with a bypass feature for the STO function in single-safety controller configurations. You can use the MDC feature to allow motion while following all necessary and prescribed steps per your machine's safety operating procedures.



**ATTENTION:** Consider the consequences of allowing motion through the use of MDC when the controller is in Program mode. You must acknowledge warning messages in the Logix Designer application that warn of the drive bypassing the STO function and unintended motion can occur. The integrated safety drive does not respond to requests of the STO function if MDC mode is entered.

**ATTENTION:** It is your responsibility to maintain machine safety integrity while executing motion direct commands. One alternative is to provide ladder logic for Machine Maintenance mode that leaves the controller in Run mode with safety functions executing.

## Logix Designer Application Warning Messages

When the controller is in Run mode, executing safety functions, the PowerFlex 527 drive follows the commands that it receives from the safety controller. The controller will report Safety state = Running and Axis state = Stopped/Running, as shown in [Figure 4](#).

Figure 4 - Safety State Indications When Controller is in Run Mode (Safety Task Executing)

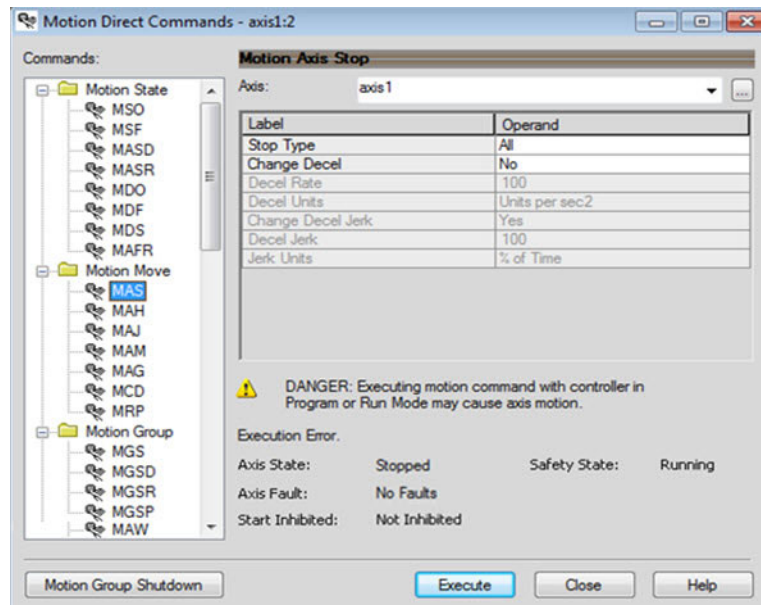

When the controller transitions to Program mode, the integrated safety drive is in the safe state and torque is not permitted. The controller will report Safety state = Not Running and Axis state = Start Inhibited, as shown in [Figure 5](#).

**Figure 5 - Safety State Indications After Controller Transitions to Program Mode**

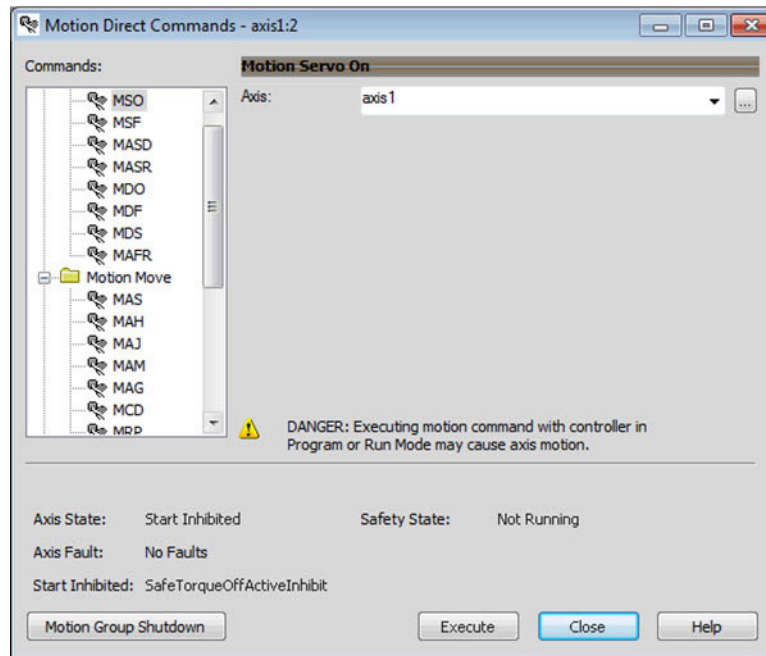

When you issue a motion direct command to an axis to produce torque in Program mode, for example MSO or MDS, with the safety connection present to the drive, a warning message is presented before the motion direct command is executed, as shown in [Figure 6](#).

**Figure 6 - STO Bypass Prompt When the Safety Controller is in Program Mode**

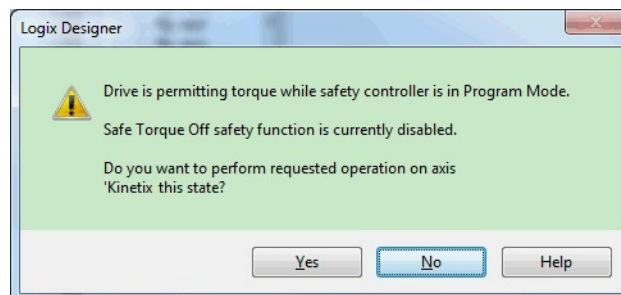

The warning in [Figure 6](#) is displayed the first time a motion direct command is issued.

After you acknowledge the warning message by clicking Yes, torque is permitted by the drive and a warning message is indicated in the software as shown in [Figure 7 on page 112](#). The controller will report Safety state = Not Running (Torque Permitted), Axis state = Stopped/Running, and Persistent Warning = Safe Torque Off Bypassed.

---

**IMPORTANT** Switch the controller to Run mode to exit Motion Direct Command mode and end the bypass of the STO function.

---

Figure 7 - Safety State Indications After Controller Transitions to Program Mode (MDC Executing)

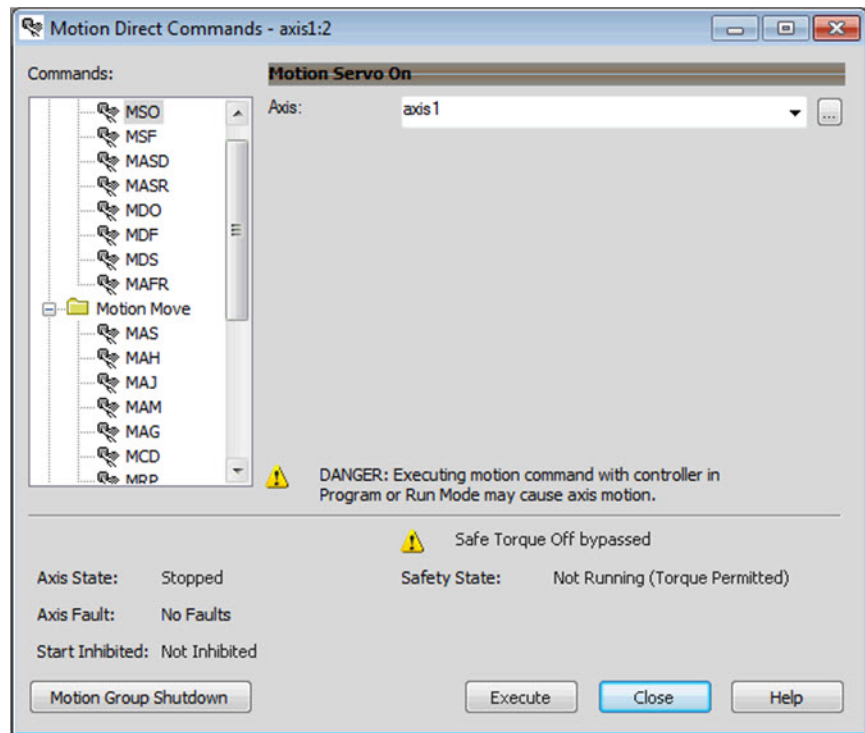

**IMPORTANT** The persistent warning message text Safe Torque Off bypassed appears when a motion direct command is executed. The warning message persists - even after the dialog is closed and reopened - as long as the integrated safety drive is in STO Bypass mode. The persistent warning message is removed only after the integrated safety drive is restored to the Safe state.

### Torque Permitted in a Multi-workstation Environment

The warning in [Figure 8](#) is displayed to notify a second user working in a multi-workstation environment that the first user has placed the integrated safety drive in the STO state and that the current action is about to bypass the STO state and permit torque.

Figure 8 - STO Bypass Prompt When MDC is Issued in Multi-workstation Environment

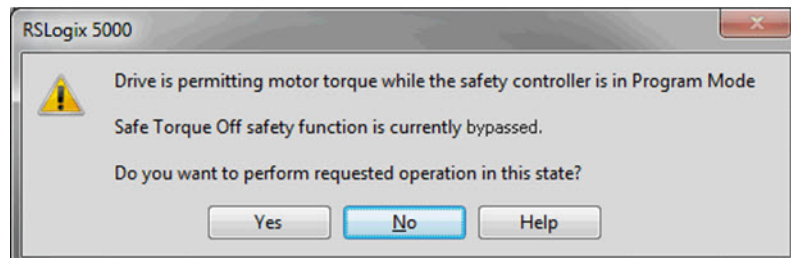

### Warning Icon and Text in Axis Properties

In addition to the other warnings that require your acknowledgment, the Logix Designer application also provides warning icons and persistent warning messages in other Axis Properties dialog boxes when the integrated safety drive is in STO Bypass mode.

### Axis and Safe State Indications on the Hookup Services Dialog Box

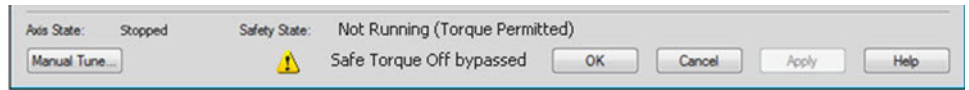

### Axis and Safe State Indications on Motion Direct Commands Dialog Box

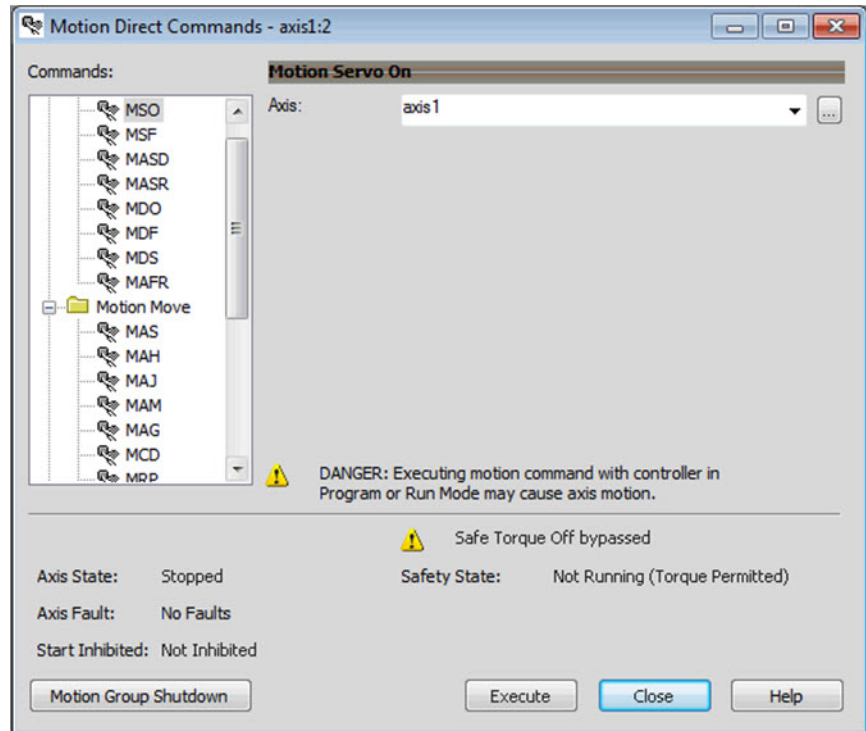

### Axis and Safe State Indications on the Motion Console Dialog Box

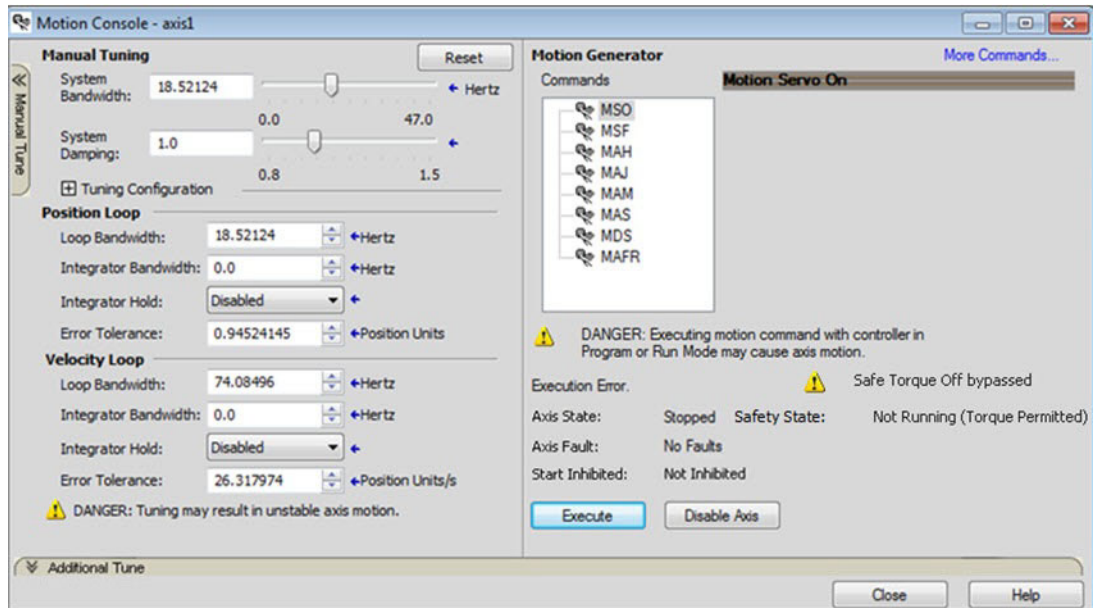

## Functional Safety Considerations



**ATTENTION:** Before maintenance work can be performed in Program mode, the developer of the application must consider the implications of allowing motion through motion direct commands and should consider developing logic for runtime maintenance operations to meet the requirements of machine safety operating procedures.

---



**ATTENTION:** Motion is allowed and the STO function is not available when motion direct commands are used in Program mode. Motion direct commands that are issued when the controller is in Program mode cause the drive to bypass the STO Active condition. It is your responsibility to implement additional preventive measures to maintain safety integrity of the machinery during execution of motion direct commands in Program mode.

---



**ATTENTION:** To avoid personal injury and damage to equipment in the event of unauthorized access or unexpected motion during authorized access, return the controller to Run mode and remove the key before leaving the machine unattended.

---



## Troubleshooting

This chapter provides troubleshooting tables and related information for your PowerFlex 527 drive.

Topic	Page
Safety Precautions	115
Interpret Status Indicators	115
General Troubleshooting	122
Logix 5000 Controller and Drive Behavior	123

### Safety Precautions

Observe the following safety precautions when troubleshooting your PowerFlex 527 drive.



**ATTENTION:** Capacitors on the DC bus can retain hazardous voltages after input power has been removed. Before working on the drive, measure the DC bus voltage to verify it has reached less than 50V DC, or wait three minutes. Failure to observe this precaution could result in severe bodily injury or loss of life.



**ATTENTION:** Do not attempt to defeat or override the drive fault circuits. You must determine the cause of a fault and correct it before you attempt to operate the system. Failure to correct the fault could result in personal injury and/or damage to equipment as a result of uncontrolled machine operation.



**ATTENTION:** Provide an earth ground for test equipment (oscilloscope) used in troubleshooting. Failure to ground the test equipment could result in personal injury.

### Interpret Status Indicators

See these troubleshooting tables to identify faults, potential causes, and the appropriate actions to resolve the fault. If the fault persists after attempting to troubleshoot the system, contact your Rockwell Automation sales representative for further assistance.

### Display Interface

The LCD display provides fault messages and troubleshooting information by using the soft menu items and navigation buttons. See [Understanding the PowerFlex 527 Display and Indicators on page 46](#) for more information.

When the drive enters a fault or inhibit scenario, the fault information will be shown and scrolled across the LCD display.

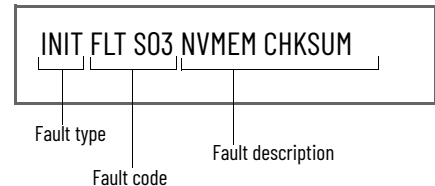

### Fault Codes

The fault code tables are designed to help you determine the source of the fault or exception. When a fault condition is detected, the drive performs the appropriate fault action, the fault is displayed, and the fault is added to a persistent fault log (along with diagnostics data). The earlier faults have priority to be displayed.

The drive removes the fault text from the display when a Fault Reset service is sent from the controller and the fault is no longer active. If a fault is still active following a Fault Reset service, the fault is again posted to the display and written to the fault log.

#### Fault Code Summary

Fault Code Type	Description
FLT Sxx	Standard runtime axis exceptions.
FLT Mxx	
INIT FLT Sxx	Exceptions that prevent normal operation and occur during the initialization process.
INIT FLT Mxx	
INHIBIT Sxx	Exceptions that prevent normal operation and indicate whenever the drive is active.
INHIBIT Mxx	
NODE FLTxx	Exceptions that prevent normal operation of the drive.
NODE ALARM xx	Exceptions that prevent normal operation of the drive, but do not result in any action other than reporting the alarm to the controller.

See [Troubleshoot the Safe Torque-Off Function on page 94](#) for information on troubleshooting SAFE FLT fault codes.



Fault codes triggered by conditions that fall outside factory set limits are identified by FL at the end of the display message. For example, FLT S07 – MTR OVERLOAD FL.

Fault codes triggered by conditions that fall outside user set limits are identified by UL at the end of the display message. For example, FLT S08 – MTR OVERLOAD UL.

#### FLT Sxx Fault Codes

Exception Code on Display	Exception Text	Problem	Possible Solutions
FLT S03 – MTR OVERSPEED FL	Motor Overspeed Factory Limit Fault	Motor speed has exceeded 590 Hz.	Check control loop tuning.
FLT S04 – MTR OVERSPEED UL	Motor Overspeed User Limit Fault	Motor speed has exceeded the user-defined speed limit that is given by Motor Overspeed User Limit.	Check control loop tuning.
FLT S07 – MTR OVERLOAD FL	Motor Thermal Overload Factory Limit Fault	The motor thermal model has exceeded its factory set thermal capacity limit of 110%.	Modify the command profile to reduce speed or increase time.
FLT S08 – MTR OVERLOAD UL	Motor Thermal Overload User Limit Fault	The motor thermal model has exceeded the thermal capacity limit that is given by Motor Thermal Overload User Limit.	<ul style="list-style-type: none"> <li>Modify the command profile.</li> <li>Increase the Motor Thermal Overload UL attribute value.</li> </ul>

## FLT Sxx Fault Codes (Continued)

Exception Code on Display	Exception Text	Problem	Possible Solutions
FLT S10 – INV OVERCURRENT	Inverter Overcurrent Fault	Inverter current has exceeded the instantaneous current limit (determined by hardware).	<ul style="list-style-type: none"> <li>Check motor power cable for shorts.</li> <li>Verify that motor windings are not shorted.</li> <li>Verify motor power wire gauge.</li> <li>Operate within the continuous power rating.</li> <li>Reduce acceleration times.</li> </ul>
FLT S11 – INV OVERTEMP FL	Inverter Overtemperature Factory Limit Fault	The measured inverter temperature has exceeded the factory set temperature limit.	<ul style="list-style-type: none"> <li>Modify the command profile to reduce speed or increase time.</li> <li>Reduce drive ambient temperature.</li> <li>Verify that airflow through drive is not obstructed.</li> </ul>
FLT S13 – INV OVERLOAD FL	Inverter Thermal Overload Factory Limit Fault	The thermal model for the power transistors indicates that the temperature has exceeded the factory set thermal capacity rating of 110%.	Modify the command profile to reduce speed or increase time.
FLT S16 – GROUND CURRENT	Ground Current Factory Limit Fault	The sensing circuitry in the power stage has detected excessive ground current.	<ul style="list-style-type: none"> <li>Check motor power wiring; check power cable for shorts.</li> <li>Replace motor if the fault persists.</li> </ul>
FLT S23 – AC PHASE LOSS	AC Single Phase Loss Fault	A single AC input phase was lost while the drive was enabled.	Check AC input voltage on all phases.
FLT S25 – PRECHARGE FAILURE	Pre-charge Failure Fault	The pre-charge circuit monitoring algorithm detected that the DC bus did not reach a factory set voltage level after charging for a period of time.	<ul style="list-style-type: none"> <li>Check AC input voltage on all phases.</li> <li>Check input power wiring.</li> <li>Replace drive if fault persists.</li> </ul>
FLT S29 – BUS OVERLOAD FL	Bus Regulator Thermal Overload Factory Limit Fault	The shunt thermal model has exceeded its factory set thermal capacity limit.	<ul style="list-style-type: none"> <li>Modify the duty cycle of the application.</li> <li>Add external shunt for additional capacity.</li> <li>Add capacitor module if needed.</li> </ul>
FLT S34 – BUS UNDERVOLT UL	Bus Undervoltage User Limit Fault	DC Bus voltage level is below the user set limit as given by Bus Undervoltage User Limit.	<ul style="list-style-type: none"> <li>Verify voltage level of the incoming AC.</li> <li>Monitor AC power source for glitches or line droop.</li> <li>Install UPS on AC input.</li> <li>Decrease Bus Undervoltage UL attribute value.</li> </ul>
FLT S35 – BUS OVERVOLT FL	Bus Overvoltage Factory Limit Fault	DC Bus voltage level is above the factory set limit as determined by the configured input voltage.	<ul style="list-style-type: none"> <li>Change the deceleration or motion profile of all drives that are connected to the DC bus.</li> <li>Unplug the shunt connector and measure the resistance of the shunt.</li> <li>Replace drive if shunt resistor is open.</li> </ul>
FLT S37 – BUS POWER LOSS	Bus Power Loss	DC Bus voltage level is below the Bus Power Loss Threshold for more than the timeout period specified Bus Power Loss Time value.	<ul style="list-style-type: none"> <li>Verify voltage level of the incoming AC.</li> <li>Monitor AC power source for glitches or line droop.</li> <li>Install UPS on AC input.</li> </ul>
FLT S41 – FDBK SIGNAL NOISE FL	Feedback Signal Noise Fault	Noise induced A/B channel state changes (illegal states) from a feedback device were detected by the drive. Specifically, the number of these noise events that have occurred on this channel has exceeded the Feedback Noise Factory Limit. The offending feedback channel number is encoded in the associated Fault/Alarm Sub Code.	<ul style="list-style-type: none"> <li>Check motor feedback cable and connector.</li> <li>Cycle power.</li> <li>Check feedback shield connection.</li> <li>Reduce shock and vibration to motor.</li> <li>Replace motor if fault continues.</li> <li>Verify all HTL/TTL DIP switches on the 25-ENC-2/B encoder are set in the same position.</li> </ul>
FLT S43 – FDBK SIG FL	Feedback Signal Loss Factory Limit Fault	The absolute value of the differential A/B signals is below a factory limit.	<ul style="list-style-type: none"> <li>Check motor feedback cable and connector.</li> <li>Check that motor power cable and feedback wire shields are secured correctly.</li> <li>Check that motor frame is grounded correctly.</li> </ul>
FLT S50 – HARDWARE OVERTRAVEL POSITIVE	Hardware Overtravel Positive	Axis moved beyond the physical travel limits in the positive direction and activated the Positive Overtravel limit switch.	<ul style="list-style-type: none"> <li>Check wiring.</li> <li>Verify motion profile.</li> <li>Verify axis configuration in software.</li> </ul>

**FLT Sxx Fault Codes (Continued)**

Exception Code on Display	Exception Text	Problem	Possible Solutions
FLT S51 – HARDWARE OVERTRAVEL NEGATIVE	Hardware Overtravel Negative	Axis moved beyond the physical travel limits in the negative direction and activated the Negative Overtravel limit switch.	<ul style="list-style-type: none"> <li>• Check wiring.</li> <li>• Verify motion profile.</li> <li>• Verify axis configuration in software.</li> </ul>
FLT S54 – POSN ERROR	Excessive Position Error Fault	The position error of the position control loop has exceeded the value that is given by Position Error Tolerance for a time period that is given by Position Error Tolerance Time.	<ul style="list-style-type: none"> <li>• Check position loop tuning.</li> <li>• Increase the feedforward gain.</li> <li>• Verify sizing of the drive and motor.</li> <li>• Check motor power wiring.</li> <li>• Increase Position Error Tolerance and/or Position Error Tolerance Time attribute values.</li> </ul>
FLT S55 – VEL ERROR	Excessive Velocity Error Fault	The velocity error of the velocity control loop has exceeded the value that is given by Velocity Error Tolerance for a time period that is given by Velocity Error Tolerance Time.	<ul style="list-style-type: none"> <li>• Check velocity loop tuning.</li> <li>• Reduce acceleration.</li> <li>• Verify sizing of the drive and motor.</li> <li>• Check motor power wiring.</li> <li>• Increase Velocity Error Tolerance and/or Velocity Error Tolerance Time attribute values.</li> </ul>
FLT S56 – OVERTORQUE LIMIT	Overtorque Limit Fault	Motor torque has risen above user-defined maximum torque level that is given by Overtorque Limit for a time period that is given by Overtorque Limit Time.	<ul style="list-style-type: none"> <li>• Verify Torque Trim value.</li> <li>• Verify motion profile.</li> <li>• Verify sizing of the drive and motor.</li> <li>• Increase Overtorque Limit and/or Overtorque Limit Time attribute values.</li> </ul>
FLT S57 – UNDERTORQUE LIMIT	Undertorque Limit Fault	Motor torque has dropped below user-defined minimum torque level that is given by Undertorque Limit for a time period that is given by Undertorque Limit Time.	<ul style="list-style-type: none"> <li>• Verify motion profile.</li> <li>• Verify sizing of the drive and motor.</li> <li>• Decrease Undertorque Limit and/or Undertorque Limit Time attribute values.</li> </ul>
FLT S61 – ENABLE INPUT DEACTIVATED	Enable Input Deactivated	Enable Input has been deactivated while the axis power structure is in Running state, enabled, and supplying current to the DC Bus or motor.	<ul style="list-style-type: none"> <li>• Verify Enable Input level.</li> <li>• Check Enable Input wiring.</li> </ul>

**FLT Mxx Fault Codes**

Exception Code on Display	Exception Text	Problem	Possible Solutions
FLT M10 – CONTROL MODULE OVERTEMPERATURE FL	Control Module Overtemperature Fault	The temperature sensor on the Main Control Board detected excessive heat.	<ul style="list-style-type: none"> <li>• Reduce drive ambient temperature.</li> <li>• Verify that airflow through drive is not obstructed.</li> <li>• Check control module internal fan. Replace if error persists.</li> </ul>
FLT M19 – DECEL OVERRIDE	Decel Override	The drive is not following a commanded deceleration because it is attempting to limit bus voltage.	<ul style="list-style-type: none"> <li>• Reprogram Bus Regulator Action to eliminate any “Adjustable Freq” selection.</li> <li>• Reprogram Bus Regulator Action to Shunt Regulator and add external shunt.</li> <li>• Correct AC input line instability or add an isolation transformer.</li> <li>• Reset drive.</li> </ul>
FLT M21 – MOTOR TEST FAILURE	Motor Test Failure	The Motor Test procedure has failed.	<ul style="list-style-type: none"> <li>• Verify sizing of the drive and motor.</li> <li>• Verify motor data.</li> <li>• Check motor power wiring.</li> </ul>
FLT M26 – RUNTIME ERROR	Runtime Error	The drive firmware encountered an unrecoverable runtime error.	<ul style="list-style-type: none"> <li>• Cycle power.</li> <li>• Reset the drive.</li> <li>• Return drive for repair if fault continues.</li> </ul>
FLT M28 – SAFETY MODULE COM ERROR	Safety Module Communication Error	Error in communicating to the Safety module.	<ul style="list-style-type: none"> <li>• Cycle power.</li> <li>• Replace module.</li> </ul>

## INIT FLT Fault Codes

Exception Code on Display	Exception Text	Problem	Possible Solutions
INIT FLT S03 - NVMEM CHKSUM	Nonvolatile Memory Checksum Error	Data in the nonvolatile memory has a checksum error.	<ul style="list-style-type: none"> <li>• Cycle power.</li> <li>• Reset the drive.</li> <li>• Return drive for repair if fault continues.</li> </ul>
INIT FLT M14 - INVALID SAFETY FIRMWARE	Invalid Safety Firmware	The safety firmware is not compatible with the drive firmware, or the main safety firmware is missing.	<ul style="list-style-type: none"> <li>• Cycle power.</li> <li>• Upgrade drive firmware.</li> <li>• Return drive for repair if fault continues.</li> </ul>
INIT FLT M15 - POWER BOARD	Power Board Checksum Error	The power board has a checksum error.	<ul style="list-style-type: none"> <li>• Cycle power.</li> <li>• Reset the drive.</li> <li>• Return drive for repair if fault continues.</li> </ul>
INIT FLT M22 - ILLEGAL ADDRESS	Illegal IP Address Configuration	<p>Invalid Ethernet IP Address configuration or device Node Address is out of range (&gt;254)</p> <p>For example, this fault will occur when the IP address and Gateway address are identical.</p> <p>When this fault occurs, IP address configuration will be changed to DHCP.</p>	Change IP address, subnet mask, and gateway address to a legal configuration and cycle power.

## INHIBIT Fault Codes

Exception Code on Display	Exception Text	Problem	Possible Solutions
INHIBIT S01 - AXIS ENABLE INPUT	Axis Enable Input	Axis Enable Input is not active.	<ul style="list-style-type: none"> <li>• Verify Enable Input level.</li> <li>• Check Enable Input wiring.</li> </ul>
INHIBIT S02 - MOTOR NOT CONFIGURED	Motor Not Configured	The motor has not been properly configured for use.	Verify motor configuration in the Studio 5000 Logix Designer application.
INHIBIT S05 - SAFE TORQUE OFF <sup>(1)</sup>	Start Inhibit - Safe Torque Off	The safety function has disabled the power structure.	<ul style="list-style-type: none"> <li>• Check that Ethernet components such as cables are secured and switches are operational.</li> <li>• Check state of safety devices.</li> </ul>
INHIBIT M05 - SAFE TORQUE OFF <sup>(2)</sup>	Start Inhibit - Safe Torque Off	The safety function has disabled the power structure.	<ul style="list-style-type: none"> <li>• Check safety input wiring.</li> <li>• Check state of safety devices.</li> </ul>

(1) Network STO.

(2) Hardwired STO.

## NODE FLT Fault Codes

Exception Code on Display	Exception Text	Problem	Possible Solutions
NODE FLT 01 - LATE CTRL UPDATE	Control Connection Update Fault	Several consecutive updates from the controller have been lost.	<ul style="list-style-type: none"> <li>• Remove unnecessary network devices from the motion network.</li> <li>• Change network topology so that fewer devices share common paths.</li> <li>• Use high-performance network equipment.</li> <li>• Use shielded cables.</li> <li>• Separate signal wiring from power wiring.</li> </ul>
NODE FLT 02 - PROC WATCHDOG nn	Processor Watchdog Fault	<p>The processor on the power board or control board failed to update in a certain amount of time.</p> <p>The nn sub-codes 00...05 are internal and result in the same possible solution.</p>	<ul style="list-style-type: none"> <li>• Cycle power.</li> <li>• Update the drive firmware.</li> <li>• Return drive for repair if fault continues.</li> </ul>
NODE FLT 03 - HARDWARE 00	Hardware Fault - PwrIF	Communication with the power board could not be established.	<ul style="list-style-type: none"> <li>• Cycle power.</li> <li>• Update the drive firmware.</li> <li>• Return drive for repair if fault continues.</li> </ul>
NODE FLT 03 - HARDWARE 01	Hardware Fault - Piccolo HW	DSP chip on the power board failure.	<ul style="list-style-type: none"> <li>• Cycle power.</li> <li>• Return motor for repair if fault continues.</li> </ul>
NODE FLT 05 - CLOCK SKEW FLT	Clock Skew Fault	The controller time and the drive system time are not the same.	<ul style="list-style-type: none"> <li>• Cycle power.</li> <li>• Check controller and Ethernet switch operation.</li> </ul>

**NODE FLT Fault Codes (Continued)**

Exception Code on Display	Exception Text	Problem	Possible Solutions
NODE FLT 06 - LOST CTRL CONN	Lost Controller Connection Fault	Communication with the controller has been lost.	<ul style="list-style-type: none"> <li>• Check Ethernet connection.</li> <li>• Check controller and Ethernet switch operation.</li> </ul>
NODE FLT 07 - CLOCK SYNC	Clock Sync Fault	Drive local clock has lost synchronization with controller's clock and was not able to resynchronize within allotted time.	<ul style="list-style-type: none"> <li>• Check Ethernet connection.</li> <li>• Check controller and Ethernet switch operation.</li> </ul>
NODE FLT 09 - DUPLICATE IP ADDRESS	Duplicate IP Address Fault	Several consecutive updates from the controller have been lost.	Select an IP address not already in use on the network.

**NODE ALARM Fault Codes**

Exception Code on Display	Exception Text	Problem	Possible Solutions
NODE ALARM 01 - LATE CTRL UPDATE	Control Connection Update Alarm	Updates from the controller have been late.	<ul style="list-style-type: none"> <li>• Remove unnecessary network devices from the motion network.</li> <li>• Change network topology so that fewer devices share common paths.</li> <li>• Use high-performance network equipment.</li> <li>• Use shielded cables.</li> <li>• Separate signal wiring from power wiring.</li> </ul>
NODE ALARM 03 - CLOCK JITTER	Clock Jitter Alarm	The sync variance has exceeded the sync threshold while the device is running in sync mode.	<ul style="list-style-type: none"> <li>• Check the Ethernet connection.</li> <li>• Check controller and Ethernet switch operation.</li> </ul>
NODE ALARM 04 - CLOCK SKEW ALARM	Clock Skew Alarm	The controller time and the drive system time are not the same.	<ul style="list-style-type: none"> <li>• Check the Ethernet connection.</li> <li>• Check controller and Ethernet switch operation.</li> </ul>
NODE ALARM 05 - CLOCK SYNC ALARM	Clock Sync Alarm	Drive local clock has lost synchronization with controller's clock for a short time during synchronous operation.	<ul style="list-style-type: none"> <li>• Check the Ethernet connection.</li> <li>• Check controller and Ethernet switch operation.</li> </ul>

**PowerFlex 527 Drive Status Indicators**

The fault status indicator is located between the LCD display and keypad. There are also four status indicators that are located at the bottom right of the drive and can be seen through the front cover of the control module.

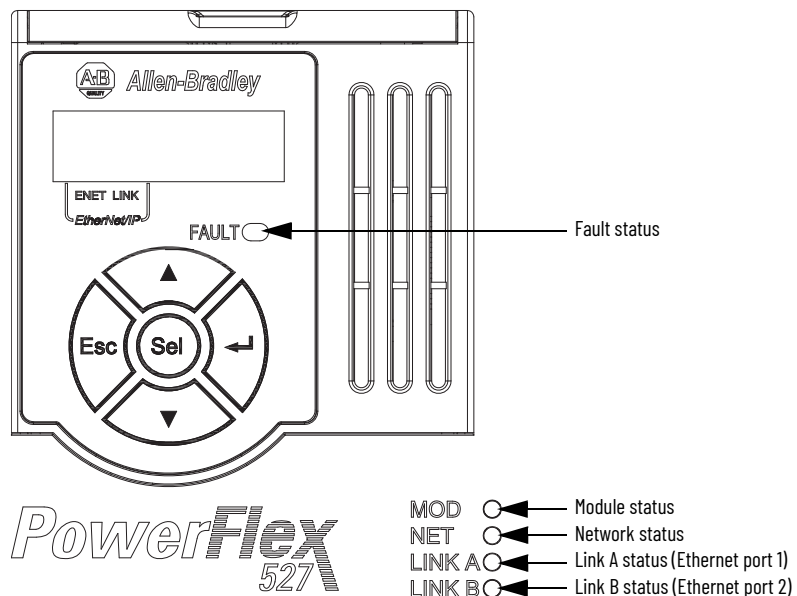

### Fault Status Indicator

Condition	Safety Supervisor State	CIP Motion Axis State	Governing Object	Identity State
Steady Red	Any State <sup>(1)</sup>	Aborting	Motion Axis	Major Recoverable or Major Unrecoverable
Steady Red	Any State <sup>(1)</sup>	Major Faulted	Motion Axis	Major Recoverable or Major Unrecoverable
Steady Red	Abort	Any State <sup>(1)</sup>	Safety Supervisor	Major Recoverable
Steady Red	Critical Fault	Any State <sup>(1)</sup>	Safety Supervisor	Major Unrecoverable

(1) "Any State" means any state that has lower precedence.

### Module Status Indicator

Condition	Safety Supervisor State	CIP Motion Axis State	Governing Object	Identity State
Flashing Green/Red	Self-Testing	Any State <sup>(1)</sup>	Safety Supervisor	Device Self-Testing
Flashing Green/Red	Any State <sup>(1)</sup>	Self-Testing	Motion Axis	Device Self-Testing
Steady Red	Self-Test Exception	Any State <sup>(1)</sup>	Safety Supervisor	Major Unrecoverable
Flashing Green/Red	Waiting for TUNID <sup>(2)</sup>	Any State <sup>(1)</sup>	Safety Supervisor	Standby
Flashing Green/Red	Configuring	Any State <sup>(1)</sup>	Safety Supervisor	Standby
Flashing Green	Idle	Any State <sup>(1)</sup>	Safety Supervisor	Standby
Flashing Green	<ul style="list-style-type: none"> <li>Waiting for TUNID with Torque Permitted<sup>(2)(3)</sup></li> </ul>	<ul style="list-style-type: none"> <li>Initializing</li> <li>Pre-Charge</li> <li>Shutdown</li> <li>Start Inhibit</li> </ul>	Motion Axis	Standby
Steady Green	<ul style="list-style-type: none"> <li>Executing</li> <li>Executing with Torque Permitted<sup>(4)</sup></li> </ul>	<ul style="list-style-type: none"> <li>Stopped</li> <li>Stopping</li> <li>Starting</li> <li>Running</li> <li>Testing</li> </ul>	Motion Axis	Operational
Flashing Red or Steady Red	Any State <sup>(1)</sup>	Aborting	Motion Axis	Major Recoverable or Major Unrecoverable
Flashing Red	Any State <sup>(1)</sup>	Major Faulted	Motion Axis	Major Recoverable or Major Unrecoverable
Flashing Red	Abort	Any State <sup>(1)</sup>	Safety Supervisor	Major Recoverable
Steady Red	Critical Fault	Any State <sup>(1)</sup>	Safety Supervisor	Major Unrecoverable

(1) "Any State" means any state that has lower precedence.

(2) After Propose\_TUNID service request, the Network Status indicator flashes Green/Red (fast flash) until successful Apply\_TUNID.

(3) Unlike many safety I/O devices, a CIP Motion safety drive is free to operate in its "Out-of-Box" state. This behavior is made explicit by the device specific Safety Supervisor state, Waiting for TUNID with Torque Permitted. In this "Out-of-Box" state, operation of the CIP Motion safety drive is the same as that of a CIP Motion drive to facilitate commissioning.

(4) Unlike many safety I/O devices, a CIP Motion safety drive may be operated when the safety output assemblies Run/Idle bit is set to Idle. If in the Executing state, the Run/Idle bit is set to Idle, the device is forced to a Safe State. However, if in this condition, the safety controller sends a Mode\_Change service request with Torque Permitted to the Safety Stop Functions object, drive operation is permitted while the Run/Idle bit remains Idle. See the Safety Stop Function object for details on the Mode\_Change service.

### Network Status Indicator

Condition	Status
Off	No power applied to the drive or IP address is not configured.
Flashing Green	Drive connection is not established, but has obtained an IP address.
Steady Green	Drive is online and has connections in the established state.
Flashing Red	One or more Exclusive Owner connections has timed out.
Steady Red	Duplicate IP address. IP address that is specified is already in use.
Flashing Green/Red (slow flash)	The drive performs self-test during powerup.
Flashing Green/Red (fast flash)	Safety Supervisor is waiting for "Apply TUNID" service request.

**Link A Status Indicator (Ethernet Port 1)**

Condition	Status
Off	Drive is not connected to the network.
Steady Green	Drive is connected to the network but not transmitting data.
Flashing Green	Drive is connected to the network and transmitting data.

**Link A Status Indicator (Ethernet Port 2)**

Condition	Status
Off	Drive is not connected to the network.
Steady Green	Drive is connected to the network but not transmitting data.
Flashing Green	Drive is connected to the network and transmitting data.

**General Troubleshooting**

These conditions do not always result in a fault code, but can require troubleshooting to improve performance.

**General Troubleshooting**

Condition	Potential Cause	Possible Resolution
Axis or system is unstable.	The position feedback device is incorrect or open.	Check wiring.
	Motor tuning limits are set too high.	Run Tune in the Logix Designer application.
	Position loop gain or position controller accel/decel rate is improperly set.	Run Tune in the Logix Designer application.
	Improper grounding or shielding techniques are causing noise to be transmitted into the position feedback or velocity command lines, causing erratic axis movement.	Check wiring and ground.
	Motor Data is incorrectly set (induction motor is not matched to axis module).	<ul style="list-style-type: none"> <li>Check setups.</li> <li>Run Motor Test in the Logix Designer application.</li> </ul>
	Mechanical resonance.	Notch filter or output filter can be required (refer to Axis Properties dialog box, Output tab in the Logix Designer application).
You cannot obtain the motor acceleration/deceleration that you want.	Torque Limit limits are set too low.	Verify that torque limits are set properly.
	Incorrect motor selected in configuration.	Select the correct motor and run Tune in the Logix Designer application again.
	The system inertia is excessive.	<ul style="list-style-type: none"> <li>Check motor size versus application need.</li> <li>Review induction system sizing.</li> </ul>
	The system friction torque is excessive.	Check motor size versus application need.
	Available current is insufficient to supply the correct accel/decel rate.	<ul style="list-style-type: none"> <li>Check motor size versus application need.</li> <li>Review induction system sizing.</li> </ul>
	Acceleration limit is incorrect.	Verify limit settings and correct them, as necessary.
	Velocity Limit limits are incorrect.	Verify limit settings and correct them, as necessary.
Motor does not respond to a command.	The motor wiring is open.	Check the wiring.
	The motor cable shield connection is improper.	<ul style="list-style-type: none"> <li>Check feedback connections.</li> <li>Check cable shield connections.</li> </ul>
	The motor has malfunctioned.	Repair or replace the motor.
	The coupling between motor and machine has broken (for example, the motor moves, but the load/machine does not).	Check and correct the mechanics.
	Primary operation mode is set incorrectly.	Check and properly set the limit.
	Velocity or torque limits are set incorrectly.	Check and properly set the limits.
	Brake connector not wired	Check brake wiring.



## General Troubleshooting (Continued)

Condition	Potential Cause	Possible Resolution
Presence of noise on command or motor feedback signal wires.	Recommended grounding per installation instructions have not been followed.	<ul style="list-style-type: none"> <li>Verify grounding.</li> <li>Route wire away from noise sources.</li> <li>See the System Design for Control of Electrical Noise Reference Manual, publication <a href="#">GMC-RM001</a>.</li> </ul>
	Line frequency can be present.	<ul style="list-style-type: none"> <li>Verify grounding.</li> <li>Route wire away from noise sources.</li> </ul>
	Variable frequency can be velocity feedback ripple or a disturbance that is caused by gear teeth or ballscrew, and so forth. The frequency can be a multiple of the motor power transmission components or ballscrew speeds resulting in velocity disturbance.	<ul style="list-style-type: none"> <li>Decouple the motor for verification.</li> <li>Check and improve mechanical performance, for example, the gearbox or ballscrew mechanism.</li> </ul>
No rotation	The motor connections are loose or open.	Check motor wiring and connections.
	Foreign matter is lodged in the motor.	Remove foreign matter.
	The motor load is excessive.	Verify the induction system sizing.
	The bearings are worn.	Return the motor for repair.
	The motor brake is engaged (if supplied).	<ul style="list-style-type: none"> <li>Check brake wiring and function.</li> <li>Return the motor for repair.</li> </ul>
	The motor is not connected to the load.	Check coupling.
Motor overheating	The duty cycle is excessive.	Change the command profile to reduce accel/decel or increase time.
	The rotor is partially demagnetized causing excessive motor current.	Return the motor for repair.
Abnormal noise	Motor tuning limits are set too high.	Run Tune in the Logix Designer application.
	Loose parts are present in the motor.	<ul style="list-style-type: none"> <li>Remove the loose parts.</li> <li>Return motor for repair.</li> <li>Replace motor.</li> </ul>
	Through bolts or coupling is loose.	Tighten bolts.
	The bearings are worn.	Return motor for repair.
	Mechanical resonance.	Notch filter can be required (See the Axis Properties dialog box, Output tab in the Logix Designer application).
Erratic operation - Motor locks into position, runs without control or with reduced torque.	Motor power phases U and V, U and W, or V and W reversed.	Check and correct motor power wiring.

## Logix 5000 Controller and Drive Behavior

By using the Logix Designer application, you can configure how the PowerFlex 527 drives respond when a drive fault/exception occurs.



The INIT FLT xxx faults are always generated after powerup, but before the drive is enabled, so the stopping behavior does not apply. NODE ALARM xxx faults do not apply because they do not trigger stopping behavior.

The drive supports fault action for Ignore, Alarm, Minor Fault, and Major Fault as defined in [Table 13](#). See the drive behavior tables beginning on [page 125](#) for information on how the fault and stopping actions apply to each of the exception fault codes.

The drive supports these configurable stopping actions<sup>(1)</sup>:

- Disable and Coast
- Current Decel and Disable
- Ramped Decel and Disable

(1) **Disable and Coast** and **Current Decel and Disable** are available in Frequency Control, Velocity Loop and Position Loop. **Ramped Decel and Disable** is available in Frequency Control and Velocity Loop only and is not supported in Position Loop.

## PowerFlex 527 Drive Exception Behavior

For PowerFlex 527 drives, you can configure exception behavior in the Logix Designer application from the Axis Properties dialog box, Actions category.

**Table 13 - PowerFlex 527 Drive Exception Action Definitions**

Exception Action	Definition
Ignore	The controller completely ignores the exception condition. For some exceptions that are fundamental to the operation of the planner, Ignore is not an available option.
Alarm	The controller sets the associated bit in the Motion Alarm Status word, but does not otherwise affect axis behavior. Like Ignore, if the exception is so fundamental to the drive, Alarm is not an available option. When an exception action is set to Alarm, the Alarm goes away by itself when the exceptional condition has cleared.
Fault Status Only - Minor Fault	Like Alarm, Fault Status Only instructs the controller to set the associated bit in the Motion Fault Status word, but does not otherwise affect axis behavior. However, unlike Alarm an explicit Fault Reset is required to clear the fault once the exceptional condition has cleared. Like Ignore and Alarm, if the exception is so fundamental to the drive, Fault Status Only is not an available option.
Stop Planner - Minor Fault	The controller sets the associated bit in the Motion Fault Status word and instructs the Motion Planner to perform a controlled stop of all planned motion at the configured maximum deceleration rate and holds at zero speed. An explicit Fault Reset is required to clear the fault once the exceptional condition has cleared. If the exception is so fundamental to the drive, Stop Planner is not an available option.
Stop Drive - Major Fault	When the exception occurs, the associated bit in the Fault Status word is set and the axis comes to a stop by using the stopping action that is defined by the drive for the particular exception that occurred. There is no controller based configuration to specify what the stopping action is, the stopping action is device dependent.
Shutdown - Major Fault	When the exception occurs, the drive brings the motor to a stop by using the stopping action defined by the drive (as in Stop Drive) and the power module is disabled. An explicit Shutdown Reset is required to restore the drive to operation.

Only selected drive exceptions are configurable. In the fault behavior tables, the controlling attribute is given for programmable fault actions.

### Logix Designer Axis Properties - Actions Category

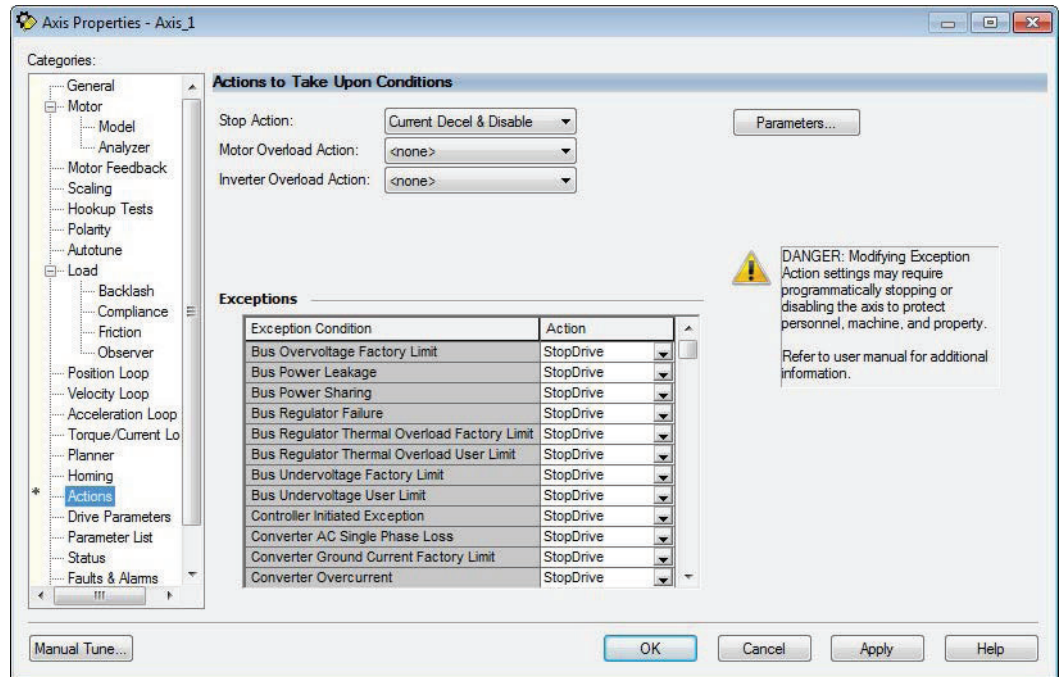

## Drive Behavior, FLT Sxx Fault Codes

Exception Fault Code	Exception Text	Induction Motor	Fault Action				Best Available Stopping Action (applies to major faults)
			Ignore	Alarm	Minor Fault	Major Fault	
FLT S03 – MTR OVERSPEED FL	Motor Overspeed Factory Limit Fault	X				X	Disable and Coast
FLT S04 – MTR OVERSPEED UL	Motor Overspeed User Limit Fault	X	X	X	X	X	Disable and Coast
FLT S07 – MTR OVERLOAD FL	Motor Thermal Overload Factory Limit Fault	X				X	Disable and Coast
FLT S08 – MTR OVERLOAD UL	Motor Thermal OverLoad User Limit Fault	X	X	X	X	X	Disable and Coast
FLT S10 – INV OVERCURRENT	Inverter Overcurrent Fault	X				X	Disable and Coast
FLT S11 – INV OVERTEMP FL	Inverter Overtemperature Factory Limit Fault	X				X	Disable and Coast
FLT S13 – INV OVERLOAD FL	Inverter Thermal Overload Factory Limit Fault	X				X	Disable and Coast
FLT S16 – GROUND CURRENT	Ground Current Factory Limit Fault	X				X	Disable and Coast
FLT S23 – AC PHASE LOSS	AC Single Phase Loss Fault	X	X	X	X	X	Disable and Coast
FLT S25 – PRECHARGE FAILURE	Pre-charge Failure Fault	X				X	Disable and Coast
FLT S29 – BUS OVERLOAD FL	Bus Regulator Thermal OverLoad Factory Limit Fault	X				X	Disable and Coast
FLT S34 – BUS UNDERVOLT UL	Bus Undervoltage User Limit Fault	X	X	X	X	X	Disable and Coast
FLT S35 – BUS OVERVOLT FL	Bus Overvoltage Factory Limit Fault	X				X	Disable and Coast
FLT S37 – BUS POWER LOSS	Bus Power Loss	X	X	X	X	X	Disable and Coast
FLT S41 – FDBK SIGNAL NOISE FL	Feedback Signal Noise Fault	X	X	X	X	X	Disable and Coast
FLT S43 – FDBK SIG FL	Feedback Signal Loss Factory Limit Fault	X	X	X	X	X	Disable and Coast
FLT S50 – HARDWARE OVERTRAVEL POSITIVE	Hardware Overtravel Positive	X	X	X	X	X	Current Decel and Disable
FLT S51 – HARDWARE OVERTRAVEL NEGATIVE	Hardware Overtravel Negative	X	X	X	X	X	Current Decel and Disable
FLT S54 – POSN ERROR	Excessive Position Error Fault	X	X	X	X	X	Disable and Coast
FLT S55 – VEL ERROR	Excessive Velocity Error Fault	X	X	X	X	X	Disable and Coast
FLT S56 – OVERTORQUE LIMIT	Overtorque Limit Fault	X	X	X	X	X	Disable and Coast
FLT S57 – UNDERTORQUE LIMIT	Undertorque Limit Fault	X	X	X	X	X	Disable and Coast
FLT S61 – ENABLE INPUT DEACTIVATED	Enable Input Deactivated	X	X	X	X	X	Disable and Coast

## Drive Behavior, FLT Mxx Fault Codes

Exception Fault Code	Exception Text	Induction Motor	Fault Action				Best Available Stopping Action (applies to major faults)
			Ignore	Alarm	Minor Fault	Major Fault	
FLT M10 – CONTROL MODULE OVERTEMPERATURE FL	Control Module Overtemperature Fault	X				X	Disable and Coast
FLT M19 – DECEL OVERRIDE	Decel Override	X	X	X	X	X	Disable and Coast
FLT M21 – MOTOR TEST FAILURE	Motor Test Failure	X				X	Disable and Coast
FLT M26 – RUNTIME ERROR	Runtime Error	X				X	Disable and Coast
FLT M28 – SAFETY COMM	Safety Module Communication Error	X				X	Disable and Coast

## Drive Behavior, NODE FLT xx Fault Codes

Exception Fault Code	Exception Text	Induction Motor	Fault Action				Best Available Stopping Action (applies to major faults)
			Ignore	Alarm	Minor Fault	Major Fault	
NODE FLT 01 – LATE CTRL UPDATE	Control Connection Update Fault	X				X	Current Decel and Disable
NODE FLT 02 – PROC WATCHDOG	Processor Watchdog Fault	X				X	Disable and Coast
NODE FLT 03 – HARDWARE	Hardware Fault	X				X	Disable and Coast
NODE FLT 05 – CLOCK SKEW FLT	Clock Skew Fault	X				X	Disable and Coast

## Drive Behavior, NODE FLT xx Fault Codes (Continued)



Exception Fault Code	Exception Text	Induction Motor	Fault Action				Best Available Stopping Action (applies to major faults)
			Ignore	Alarm	Minor Fault	Major Fault	
NODE FLT 06 - LOST CTRL CONN	Lost Controller Connection Fault	X				X	Current Decel and Disable
NODE FLT 07 - CLOCK SYNC	Clock Sync Fault	X				X	Disable and Coast
NODE FLT 09 - DUPLICATE IP ADDRESS	Duplicate IP Address Fault	X				X	Disable and Coast

## Supplemental Drive Information





Topic	Page
Certifications	127
Environmental Specifications	128
Technical Specifications	129
Power Specifications	132

### Certifications

#### Certifications

Certifications	PowerFlex 527
<b>c-UL-us</b> 	Listed to UL61800 and CAN/CSA-C22.2 No. 14-05.
<b>RCM</b> 	Australian Communications and Media Authority In conformity with the following: Radiocommunications Act: 1992 (including amendments up to 2018) Radiocommunications (Electromagnetic Compatibility) Standard: 2017 Radiocommunications Labeling (Electromagnetic Compatibility) Notice: 2017 Standards applied: EN 61800-3
<b>CE</b> 	In conformity with the following European Directives: 2014/35/EU Low Voltage Directive (LVD) 2014/30/EU EMC Directive (EMC) 2014/34/EU ATEX Directive (ATEX) 2006/42/EC Machinery Directive (MD) 2011/65/EU RoHS Directive (RoHS) Standards applied: EN 61800-5-1 EN 61800-3 EN 50495
<b>UKCA</b>	In conformity with the following UK Regulations: 2016 No. 1101 Electrical Equipment (Safety) Regulations (LV) 2016 No. 1091 Electromagnetic Compatibility Regulations (EMC) 2016 No. 1107 Equipment and Protective Systems Intended for Use in Potentially Explosive Atmospheres Regulations (Ex) 2008 No. 1597 Supply of Machinery (Safety) Regulations (MD) 2012 No. 3032 Restriction of the Use of Certain Hazardous Substances in Electrical and Electronic Equipment Regulations (RoHS) 2021 No. 745 Ecodesign for Energy-Related Products and Energy Information Regulations (Eco) Standards applied: EN 61800-5-1 EN 61800-3 EN 50495

Certifications (Continued)

Certifications	PowerFlex 527
<b>Functional Safety</b> 	TÜV Rheinland Standards applied: EN ISO 13849-1 EN 61800-5-2 EN 62061 EN 60204-1 IEC 61508 Part 1-7 Certified to ISO 13849-1 SIL3/PLe with embedded Safe Torque-Off function Certified to ISO 61800-5-2 and EN 62061 SIL3/PLe with Network Torque-Off function Meets Functional Safety (FS) when used with embedded Safe Torque-Off function
<b>ATEX</b>  <b>TÜV 15 ATEX 7696 X</b> <b>TUV 21 UKEX 7033 X</b>	Certified to ATEX Directive 2014/34/EU Group II Category (2) GD Applications with ATEX Approved Motors  Certified to UK Equipment and Protective Systems Intended for Use in Potentially Explosive Atmospheres Regulations (2016 No. 1107) Group II Category (2) GD Applications with ATEX Approved Motors
<b>KCC</b>	Korean Registration of Broadcasting and Communications Equipment Compliant with the following standards: Article 58-2 of Radio Waves Act, Clause 3
<b>EAC</b> 	Customs Union: Low Voltage TR CU 004/2011 EMC TR CU 020/2011
<b>AC 156</b>	Tested by Trentec to be compliant with AC156 Acceptance Criteria for Seismic Qualification Testing of Nonstructural Components and 2003 International Building Code for worst-case seismic level for USA excluding site class F
<b>SEMI F47</b>	Electric Power Research Institute Certified compliant with the following standards: SEMI F47 IEC 61000-4-34
<b>ODVA</b> 	ODVA conformance tested to EtherNet/IP specifications
<b>Lloyd's Register</b>	Lloyd's Register Type Approval Certificate 15/80016(E1)
<b>IEEE P1668</b>	Product meets the requirements of IEEE P1668
<b>RoHS</b>	Compliant with the European "Restriction of Hazardous Substances" Directive

The drive is also designed to meet the appropriate portions of the following specifications:  
 NFPA 70 - US National Electrical Code  
 NEMA ICS 7.1 - Safety standards for Construction and Guide for Selection, Installation and Operation of Adjustable Speed Drive Systems.

Environmental Specifications

Environmental Specifications

Specifications	PowerFlex 527
Altitude Without derating With derating	See <a href="#">Current Derating Curves on page 15</a> for derating guidelines. 1000 m (3300 ft) max. Up to 4000 m (13,200 ft) max., with the exception of 600V drives @ 2000 m (6600 ft) max.
Max. Surrounding Air Temperature Without derating With derating	See <a href="#">Current Derating Curves on page 15</a> for derating guidelines. -20...+50 °C (-4...+22 °F) -20...+60 °C (-4...+140 °F) or -20...+70 °C (-4...+158 °F) with optional Control Module Fan kit
Storage Temperature Frame A...D Frame E	-40...+85 °C (-40...+185 °F) -40...+70 °C (-40...+158 °F)

## Environmental Specifications (Continued)

Specifications		PowerFlex 527		
Atmosphere	<b>IMPORTANT</b> Drive <b>must not</b> be installed in an area where the ambient atmosphere contains volatile or corrosive gas, vapors or dust. If the drive is not going to be installed for a period of time, it must be stored in an area where it will not be exposed to a corrosive atmosphere.			
Relative Humidity	0...95% noncondensing			
Shock	Complies with IEC 60068-2-27			
Vibration	Complies with IEC 60068-2-6:2007			
Frame Size	Operating and Nonoperating		Nonoperating (Transportation)	
	Force (Shock/Vibration)	Mounting Type	Force (Shock/Vibration)	Mounting Type
A	15 g / 2 g	DIN rail or screw	30 g/ 2.5 g	Screw only
B	15 g / 2 g	DIN rail or screw	30 g/ 2.5 g	Screw only
C	15 g / 2 g	DIN rail or screw	30 g/ 2.5 g	Screw only
D	15 g / 2 g	Screw only	30 g/ 2.5 g	Screw only
E	15 g / 1.5 g	Screw only	30 g/ 2.5 g	Screw only
Conformal Coating	Complies with: IEC 60721-3-3 to level 3C2 (chemical and gases only)			
Surrounding Environment Pollution Degree Pollution Degree 1 & 2	See <a href="#">Pollution Degree Ratings According to EN 61800-5-1 on page 37</a> for descriptions. All enclosures acceptable.			
Sound Pressure Level (A-weighted) Frame A & B Frame C Frame D Frame E	Measurements are taken 1 m from the drive.  Maximum 53 dBA Maximum 57 dBA Maximum 64 dBA Maximum 68 dBA			

## Technical Specifications

## Protection

Specifications		PowerFlex 527	
Bus Overvoltage Trip 100...120V AC Input 200...240V AC Input 380...480V AC Input 525...600V AC Input	405V DC bus (equivalent to 150V AC incoming line) 405V DC bus (equivalent to 290V AC incoming line) 810V DC bus (equivalent to 575V AC incoming line) 1005V DC bus (equivalent to 711V AC incoming line)		
Bus Undervoltage Trip 100...120V AC Input 200...240V AC Input 380...480V AC Input 525...600V AC Input	190V DC bus (equivalent to 75V AC incoming line) 190V DC bus (equivalent to 150V AC incoming line) 390V DC bus (equivalent to 275V AC incoming line) 487V DC bus (equivalent to 344V AC incoming line)		
Power Ride-Thru	100 ms		
Logic Control Ride-Thru	0.5 s minimum, 2 s typical		
Electronic Motor Overload Protection	Provides class 10 motor overload protection according to NEC article 430 and motor over-temperature protection according to NEC article 430.126 (A) (2). UL 508C File 29572.		
Overcurrent	200% hardware limit, 300% instantaneous fault		
Ground Fault Trip	Phase-to-ground on drive output		
Short Circuit Trip	Phase-to-phase on drive output		

*Electrical*

Specifications	PowerFlex 527
Voltage Tolerance	-15% / +10%
Frequency Tolerance	47...63 Hz
Input Phases	3-Phase input provides full rating. 1-Phase input provides 35% rating on 3-phase drives.
Displacement Power Factor	0.98 across entire speed range
Maximum Short Circuit Rating	100,000 Amps Symmetrical
Actual Short Circuit Rating	Determined by AIC Rating of installed fuse/circuit breaker
Transistor Type	Isolated Gate Bipolar Transistor (IGBT)
Internal DC Bus Choke	Only for Frame E drive ratings
200...240V AC Input	11 kW (15 HP)
380...480V AC Input	15...18.5 kW (20...25 HP) – Heavy Duty
525...600V AC Input	15...18.5 kW (20...25 HP) – Heavy Duty

*Control*

Specifications	PowerFlex 527
Method	<ul style="list-style-type: none"> <li>• Frequency Control:                             <ul style="list-style-type: none"> <li>- Basic Volts/Hertz</li> <li>- Fan/Pump Volts/Hertz</li> <li>- Sensorless Vector Control (SVC)</li> <li>- Sensorless Vector Control (SVC) Economizer</li> </ul> </li> <li>• Position Loop:                             <ul style="list-style-type: none"> <li>- Closed Loop Position Vector Control (with optional encoder card)</li> </ul> </li> <li>• Velocity Loop:                             <ul style="list-style-type: none"> <li>- Closed Loop Velocity Vector Control (with optional encoder card)</li> </ul> </li> </ul>
Carrier Frequency	2...8 kHz, Drive rating based on 4 kHz
Frequency Accuracy	Within ±0.05% of set output frequency
Performance	
V/Hz (Volts per Hertz)	±1% of base speed across a 60:1 speed range
SVC (Sensorless Vector)	±0.5% of base speed across a 100:1 speed range
SVC Economizer	±0.5% of base speed across a 100:1 speed range
Performance with Encoder Closed Loop Velocity Vector Control	±0.1% of base speed across a 100:1 speed range
Output Voltage Range	0V to rated motor voltage
Output Frequency Range	0...590 Hz (programmable)
Efficiency	97.5% (typical)



*Control (Continued)*

Specifications		PowerFlex 527
Stop Modes		Multiple programmable stop modes including – Disable and Coast, Current Decel and Disable, and Ramped Decel and Disable
Accel/Decel		“REAL” tag programmable with Studio 5000 motion instructions. For more information, see the Logix 5000 Controllers Motion Instructions Reference Manual, publication <a href="#">MOTION-RM002</a> .
Intermittent Overload Normal Duty		110% Overload capability for up to 60 s, 150% for up to 3 s Applies to following drives: <ul style="list-style-type: none"> <li>• 25C-B048*</li> <li>• 25C-B062*</li> <li>• 25C-D030*</li> <li>• 25C-D030*</li> <li>• 25C-D037*</li> <li>• 25C-D043*</li> <li>• 25C-E022*</li> <li>• 25C-E027*</li> <li>• 25C-E032*</li> </ul>
Heavy Duty		150% Overload capability for up to 60 s, 180% for up to 3 s Applies to following drives: <ul style="list-style-type: none"> <li>• 25C-V2P5*</li> <li>• 25C-V4P8*</li> <li>• 25C-V6P0*</li> <li>• 25C-A2P5*</li> <li>• 25C-A4P8*</li> <li>• 25C-A8P0*</li> <li>• 25C-A011*</li> <li>• 25C-B2P5*</li> <li>• 25C-B5P0*</li> <li>• 25C-B8P0*</li> <li>• 25C-B011*</li> <li>• 25C-B017*</li> <li>• 25C-B024*</li> <li>• 25C-B032*</li> <li>• 25C-D1P4*</li> <li>• 25C-D2P3*</li> <li>• 25C-D4P0*</li> <li>• 25C-D6P0*</li> <li>• 25C-D010*</li> <li>• 25C-D013*</li> <li>• 25C-D017*</li> <li>• 25C-D024*</li> <li>• 25C-E0P9*</li> <li>• 25C-E1P7*</li> <li>• 25C-E3P0*</li> <li>• 25C-E4P2*</li> <li>• 25C-E6P6*</li> <li>• 25C-E9P9*</li> <li>• 25C-E012*</li> <li>• 25C-E019*</li> </ul>

*Control Inputs*

Specifications		PowerFlex 527
Digital	Quantity	(4) Programmable
	Current	6 mA
	Type Source Mode (SRC) Sink Mode (SNK)	18...24V = ON, 0...6V = OFF 0...6V = ON, 18...24V = OFF
Analog	Quantity	(2) Isolated, ±10V and 4-20mA
	Specification	
	Resolution	10-bit
	±10V DC Analog	100k ohm input impedance
4-20mA Analog	250 ohm input impedance	
External Pot	1...10k ohm, 2 W minimum	

### Control Inputs (Continued)

Specifications		PowerFlex 527
Safety (per channel)	Input Current	<10 mA
	Input ON Voltage, max	18...26.4V DC
	Input OFF Voltage, max	5V DC
	Input ON Current	10 mA
	Input OFF Current	500 µA
	Pulse Rejection Width	700 µs
	External Power Supply	SELV/PELV
Input Type	Optically isolated and reverse voltage protected	

### Control Outputs

Specifications		PowerFlex 527
Relay	Quantity	(2) 1 Programmable Form A and 1 Programmable Form B
	Specification Resistive Rating Inductive Rating	3.0 A @ 30V DC, 3.0 A @ 125V, 3.0 A @ 240V AC 0.5 A @ 30V DC, 0.5 A @ 125V, 0.5 A @ 240V AC
Opto	Quantity	(2) Programmable
	Specification	30V DC, 50 mA Non-inductive
Analog	Quantity	(1) Non-Isolated 0-10V or 0-20 mA See <a href="#">Analog Output on page 36</a> for instructions on setting the jumper. See <a href="#">Setting the ACO/AVO Attribute on page 162</a> for instructions on setting the attribute.
	Specification Resolution 0-10V DC Analog 0-20 mA Analog	10-bit 1 k Ω minimum 525 Ω maximum

### Encoder

Specifications	PowerFlex 527
Type	Incremental, dual channel
Supply	5V, 12V, 250 mA
Quadrature	90°, ±27° @ 25 °C
Duty Cycle	50%, +10%
Requirements	Encoders must be line driver type, quadrature (dual channel), 3.5...26V DC output, single-ended or differential and capable of supplying a minimum of 10 mA per channel. Allowable input is DC up to a maximum frequency of 250 kHz. The encoder I/O automatically scales to allow 5V, 12V, and 24V DC nominal voltages.

## Power Specifications

### Watts Loss

#### PowerFlex 527 Estimated Watts Loss (Rated Load, Speed and PWM)

Voltage	Output Current (A)	Total Watts Loss
100...120V, 50/60 Hz 1-Phase	2.5	27.0
	4.8	53.0
	6.0	67.0
200...240V, 50/60 Hz 1-Phase	2.5	29.0
	4.8	50.0
	8.0	81.0
200...240V, 50/60 Hz 1-Phase w/ EMC Filter	11.0	111.0
	2.5	29.0
	4.8	53.0
	8.0	84.0
	11.0	116.0

## PowerFlex 527 Estimated Watts Loss (Rated Load, Speed and PWM) (Continued)

Voltage	Output Current (A)	Total Watts Loss
200...240V, 50/60 Hz 3-Phase	2.5	29.0
	5.0	50.0
	8.0	79.0
	11.0	107.0
	17.5	148.0
	24.0	259.0
	32.2	323.0
	48.3	584.0
380...480V, 50/60 Hz 3-Phase	62.1	708.0
	1.4	27.0
	2.3	37.0
	4.0	62.0
	6.0	86.0
	10.5	129.0
	13.0	170.0
	17.0	221.0
380...480V, 50/60 Hz 3-Phase w/ EMC Filter	24.0	303.0
	30.0	387.0
	1.4	27.0
	2.3	37.0
	4.0	63.0
	6.0	88.0
	10.5	133.0
	13.0	175.0
	17.0	230.0
	24.0	313.0
525...600V, 50/60 Hz 3-Phase	30.0	402.0
	37.0	602.0
	43.0	697.0
	0.9	22.0
	1.7	32.0
	3.0	50.0
	4.2	65.0
	6.6	95.0
	9.9	138.0
	12.0	164.0
	19.0	290.0
	22.0	336.0
	27.0	466.0
	32.0	562.0

*Input Current Scaling*

## PowerFlex 527 Input Current Scaled By Motor Current

Catalog Number	Output				Input			
	1	2	3	4	5	6	7	8
<b>100...120V AC (-15%, +10%) - 1-Phase Input, 0...230V 3-Phase Output</b>								
25C-V2P5N104	2.5	2.0	1.6	1.3	9.6	7.7	6.2	4.8
25C-V4P8N104	4.8	3.8	3.1	2.4	19.2	15.4	12.5	9.6
25C-V6P0N104	6.0	4.8	3.9	3.0	24.0	19.2	15.6	12.0

## PowerFlex 527 Input Current Scaled By Motor Current (Continued)

Catalog Number	Output				Input			
	1	2	3	4	5	6	7	8
<b>200..240V AC (-15%, +10%) - 1-Phase Input, 0..230V 3-Phase Output</b>								
25C-A2P5N104	2.5	2.0	1.6	1.3	6.5	5.2	4.2	3.3
25C-A4P8N104	4.8	3.8	3.1	2.4	10.7	8.6	7.0	5.4
25C-A8PON104	8.0	6.4	5.2	4.0	18.0	14.4	11.7	9.0
25C-A011N104	11.0	8.8	7.2	5.5	22.9	18.3	14.9	11.5
<b>200..240V AC (-15%, +10%) - 1-Phase Input with EMC Filter, 0..230V 3-Phase Output</b>								
25C-A2P5N114	2.5	2.0	1.6	1.3	6.5	5.2	4.2	3.3
25C-A4P8N114	4.8	3.8	3.1	2.4	10.7	8.6	7.0	5.4
25C-A8PON114	8.0	6.4	5.2	4.0	18.0	14.4	11.7	9.0
25C-A011N114	11.0	8.8	7.2	5.5	22.9	18.3	14.9	11.5
<b>200..240V AC (-15%, +10%) - 3-Phase Input, 0..230V 3-Phase Output</b>								
25C-B2P5N104	2.5	2.0	1.6	1.3	2.7	2.2	1.8	1.4
25C-B5PON104	5.0	4.0	3.2	2.5	5.8	4.6	3.8	2.9
25C-B8PON104	8.0	6.4	5.2	4.0	9.5	7.6	6.2	4.8
25C-B011N104	11.0	8.8	7.2	5.5	13.8	11.0	9.0	6.9
25C-B017N104	17.5	14.0	11.4	8.8	21.1	16.9	13.7	10.6
25C-B024N104	24.0	19.2	15.6	12.0	26.6	21.3	17.3	13.3
25C-B032N104	32.2	25.8	20.9	16.1	34.8	27.8	22.6	17.4
25C-B048N104	48.3	38.6	31.4	24.2	44.0	35.2	28.6	22.0
25C-B062N104	62.1	49.7	40.4	31.1	56.0	44.8	36.4	28.0
<b>380..480V AC (-15%, +10%) - 3-Phase Input, 0..460V 3-Phase Output</b>								
25C-D1P4N104	1.4	1.1	0.9	0.7	1.9	1.5	1.2	1.0
25C-D2P3N104	2.3	1.8	1.5	1.2	3.2	2.6	2.1	1.6
25C-D4PON104	4.0	3.2	2.6	2.0	5.7	4.6	3.7	2.9
25C-D6PON104	6.0	4.8	3.9	3.0	7.5	6.0	4.9	3.8
25C-D010N104	10.5	8.4	6.8	5.3	13.8	11.0	9.0	6.9
25C-D013N104	13.0	10.4	8.5	6.5	15.4	12.3	10.0	7.7
25C-D017N104	17.0	13.6	11.1	8.5	18.4	14.7	12.0	9.2
25C-D024N104	24.0	19.2	15.6	12.0	26.4	21.1	17.2	13.2
25C-D030N104	30.0	24.0	19.5	15.0	33.0	26.4	21.5	16.5
<b>380..480V AC (-15%, +10%) - 3-Phase Input with EMC Filter, 0..460V 3-Phase Output</b>								
25C-D1P4N114	1.4	1.1	0.9	0.7	1.9	1.5	1.2	1.0
25C-D2P3N114	2.3	1.8	1.5	1.2	3.2	2.6	2.1	1.6
25C-D4PON114	4.0	3.2	2.6	2.0	5.7	4.6	3.7	2.9
25C-D6PON114	6.0	4.8	3.9	3.0	7.5	6.0	4.9	3.8
25C-D010N114	10.5	8.4	6.8	5.3	13.8	11.0	9.0	6.9
25C-D013N114	13.0	10.4	8.5	6.5	15.4	12.3	10.0	7.7
25C-D017N114	17.0	13.6	11.1	8.5	18.4	14.7	12.0	9.2
25C-D024N114	24.0	19.2	15.6	12.0	26.4	21.1	17.2	13.2
25C-D030N114	30.0	24.0	19.5	15.0	33.0	26.4	21.5	16.5
25C-D037N114	37.0	29.6	24.1	18.5	33.7	27.0	21.9	16.9
25C-D043N114	43.0	34.4	28.0	21.5	38.9	31.1	25.3	19.5
<b>525..600V AC (-15%, +10%) - 3-Phase Input, 0..575V 3-Phase Output</b>								
25C-E0P9N104	0.9	0.7	0.6	0.5	1.2	1.0	0.8	0.6
25C-E1P7N104	1.7	1.4	1.1	0.9	2.3	1.8	1.5	1.2
25C-E3PON104	3.0	2.4	2.0	1.5	3.8	3.0	2.5	1.9
25C-E4P2N104	4.2	3.4	2.7	2.1	5.3	4.2	3.4	2.7
25C-E6P6N104	6.6	5.3	4.3	3.3	8.0	6.4	5.2	4.0
25C-E9P9N104	9.9	7.9	6.4	5.0	11.2	9.0	7.3	5.6
25C-E012N104	12.0	9.6	7.8	6.0	13.5	10.8	8.8	6.8

**PowerFlex 527 Input Current Scaled By Motor Current (Continued)**

Catalog Number	Output				Input			
	1	2	3	4	5	6	7	8
25C-E019N104	19.0	15.2	12.4	9.5	24.0	19.2	15.6	12.0
25C-E022N104	22.0	17.6	14.3	11.0	27.3	21.8	17.7	13.7
25C-E027N104	27.0	21.6	17.6	13.5	24.7	19.8	16.1	12.4
25C-E032N104	32.0	25.6	20.8	16.0	29.2	23.4	19.0	14.6

**Notes:**

## Accessories and Dimensions

### Product Selection

#### Catalog Number Description

<b>25C</b>	<b>-</b>	<b>V</b>	<b>2P5</b>	<b>N</b>	<b>1</b>	<b>0</b>	<b>4</b>
Drive		Voltage Rating	Rating	Enclosure	HIM	Emission Class	Version

#### PowerFlex 527 Drive Ratings

Output Ratings					Input Voltage Range	Frame Size	Catalog No.
Normal Duty		Heavy Duty		Output Current (A)			
HP	kW	HP	kW				
<b>100...120V AC (-15%, +10%) - 1-Phase Input, 0...230V 3-Phase Output</b>							
0.5	0.4	0.5	0.4	2.5	85...132	A	25C-V2P5N104
1.0	0.75	1.0	0.75	4.8	85...132	B	25C-V4P8N104
1.5	1.1	1.5	1.1	6.0	85...132	B	25C-V6P0N104
<b>200...240V AC (-15%, +10%) - 1-Phase Input, 0...230V 3-Phase Output</b>							
0.5	0.4	0.5	0.4	2.5	170...264	A	25C-A2P5N104
1.0	0.75	1.0	0.75	4.8	170...264	A	25C-A4P8N104
2.0	1.5	2.0	1.5	8.0	170...264	B	25C-A8P0N104
3.0	2.2	3.0	2.2	11.0	170...264	B	25C-A011N104
<b>200...240V AC (-15%, +10%) - 1-Phase Input with EMC Filter, 0...230V 3-Phase Output</b>							
0.5	0.4	0.5	0.4	2.5	170...264	A	25C-A2P5N114
1.0	0.75	1.0	0.75	4.8	170...264	A	25C-A4P8N114
2.0	1.5	2.0	1.5	8.0	170...264	B	25C-A8P0N114
3.0	2.2	3.0	2.2	11.0	170...264	B	25C-A011N114
<b>200...240V AC (-15%, +10%) - 3-Phase Input, 0...230V 3-Phase Output</b>							
0.5	0.4	0.5	0.4	2.5	170...264	A	25C-B2P5N104
1.0	0.75	1.0	0.75	5.0	170...264	A	25C-B5P0N104
2.0	1.5	2.0	1.5	8.0	170...264	A	25C-B8P0N104
3.0	2.2	3.0	2.2	11.0	170...264	A	25C-B011N104
5.0	4.0	5.0	4.0	17.5	170...264	B	25C-B017N104
7.5	5.5	7.5	5.5	24.0	170...264	C	25C-B024N104
10.0	7.5	10.0	7.5	32.2	170...264	D	25C-B032N104
15.0	11.0	10.0	7.5	48.3	170...264	E	25C-B048N104
20.0	15.0	15.0	11.0	62.1	170...264	E	25C-B062N104
<b>380...480V AC (-15%, +10%) - 3-Phase Input, 0...460V 3-Phase Output<sup>(1)</sup></b>							
0.5	0.4	0.5	0.4	1.4	323...528	A	25C-D1P4N104
1.0	0.75	1.0	0.75	2.3	323...528	A	25C-D2P3N104
2.0	1.5	2.0	1.5	4.0	323...528	A	25C-D4P0N104
3.0	2.2	3.0	2.2	6.0	323...528	A	25C-D6P0N104
5.0	4.0	5.0	4.0	10.5	323...528	B	25C-D010N104
7.5	5.5	7.5	5.5	13.0	323...528	C	25C-D013N104
10.0	7.5	10.0	7.5	17.0	323...528	C	25C-D017N104
15.0	11.0	15.0	11.0	24.0	323...528	D	25C-D024N104

**PowerFlex 527 Drive Ratings (Continued)**

Output Ratings					Input Voltage Range	Frame Size	Catalog No.
Normal Duty		Heavy Duty		Output Current (A)			
HP	kW	HP	kW				
20.0	15.0	15.0	11.0	30.0	323...528	D	25C-D030N104
<b>380...480V AC (-15%, +10%) - 3-Phase Input with EMC Filter, 0...460V 3-Phase Output</b>							
0.5	0.4	0.5	0.4	1.4	323...528	A	25C-D1P4N114
1.0	0.75	1.0	0.75	2.3	323...528	A	25C-D2P3N114
2.0	1.5	2.0	1.5	4.0	323...528	A	25C-D4P0N114
3.0	2.2	3.0	2.2	6.0	323...528	A	25C-D6P0N114
5.0	4.0	5.0	4.0	10.5	323...528	B	25C-D010N114
7.5	5.5	7.5	5.5	13.0	323...528	C	25C-D013N114
10.0	7.5	10.0	7.5	17.0	323...528	C	25C-D017N114
15.0	11.0	15.0	11.0	24.0	323...528	D	25C-D024N114
20.0	15.0	15.0	11.0	30.0	323...528	D	25C-D030N114
25.0	18.5	20.0	15.0	37.0	323...528	E	25C-D037N114
30.0	22.0	25.0	18.5	43.0	323...528	E	25C-D043N114
<b>525...600V AC (-15%, +10%) - 3-Phase Input, 0...575V 3-Phase Output</b>							
0.5	0.4	0.5	0.4	0.9	446...660	A	25C-E0P9N104
1.0	0.75	1.0	0.75	1.7	446...660	A	25C-E1P7N104
2.0	1.5	2.0	1.5	3.0	446...660	A	25C-E3P0N104
3.0	2.2	3.0	2.2	4.2	446...660	A	25C-E4P2N104
5.0	4.0	5.0	4.0	6.6	446...660	B	25C-E6P6N104
7.5	5.5	7.5	5.5	9.9	446...660	C	25C-E9P9N104
10.0	7.5	10.0	7.5	12.0	446...660	C	25C-E012N104
15.0	11.0	15.0	11.0	19.0	446...660	D	25C-E019N104
20.0	15.0	15.0	11.0	22.0	446...660	D	25C-E022N104
25.0	18.5	20.0	15.0	27.0	446...660	E	25C-E027N104
30.0	22.0	25.0	18.5	32.0	446...660	E	25C-E032N104

(1) A non-filtered drive is not available for 380...480V AC 25 HP (18.5 kW) and 30 HP (22.0 kW) ratings. Filtered drives are available, however you must verify that the application supports a filtered drive.

**Dynamic Brake Resistors**

Drive Ratings			Minimum Resistance, $\Omega \pm 10\%$	Resistance, $\Omega \pm 5\%$	Catalog No. (1)(2)	Dynamic Brake Fuse Rating, A <sup>(3)</sup>	Fuse Model Number <sup>(4)</sup>
Input Voltage	HP	kW					
100...120V 50/60 Hz 1-Phase	0.25	0.2	56	91	AK-R2-091P500	15	PV-15A10F
	0.5	0.4	56	91	AK-R2-091P500	15	PV-15A10F
	1.0	0.75	56	91	AK-R2-091P500	15	PV-15A10F
	1.5	1.1	41	91	AK-R2-091P500	15	PV-15A10F
200...240V 50/60 Hz 1-Phase	0.25	0.2	56	91	AK-R2-091P500	15	PV-15A10F
	0.5	0.4	56	91	AK-R2-091P500	15	PV-15A10F
	1.0	0.75	56	91	AK-R2-091P500	15	PV-15A10F
	2.0	1.5	41	91	AK-R2-091P500	32	PV-32ANH1
	3.0	2.2	32	47	AK-R2-047P500	32	PV-32ANH1



Dynamic Brake Resistors (Continued)

Drive Ratings			Minimum Resistance, $\Omega \pm 10\%$	Resistance, $\Omega \pm 5\%$	Catalog No. <sup>(1)(2)</sup>	Dynamic Brake Fuse Rating, A <sup>(3)</sup>	Fuse Model Number <sup>(4)</sup>
Input Voltage	HP	kW					
200...240V 50/60 Hz 3-Phase	0.25	0.2	56	91	AK-R2-091P500	20	PV-20A10F
	0.5	0.4	56	91	AK-R2-091P500	20	PV-20A10F
	1.0	0.75	56	91	AK-R2-091P500	20	PV-20A10F
	2.0	1.5	41	91	AK-R2-091P500	20	PV-20A10F
	3.0	2.2	32	47	AK-R2-047P500	20	PV-20A10F
	5.0	4.0	18	47	AK-R2-047P500	32	PV-32ANH1
	7.5	5.5	16	30	AK-R2-030P1K2	40	PV-40ANH1
	10.0	7.5	14	30	AK-R2-030P1K2	50	1000GH-040
	15.0	11.0	14	15	AK-R2-030P1K2 <sup>(5)</sup>	80	1000GH-050
	20.0	15.0	10	15	AK-R2-030P1K2 <sup>(5)</sup>	80	1000GH-050
380...480V 50/60 Hz 3-Phase	0.5	0.4	89	360	AK-R2-360P500	10	PV-10A10F
	1.0	0.75	89	360	AK-R2-360P500	10	PV-10A10F
	2.0	1.5	89	360	AK-R2-360P500	10	PV-10A10F
	3.0	2.2	89	120	AK-R2-120P1K2	10	PV-10A10F
	5.0	4.0	47	120	AK-R2-120P1K2	20	PV-20A10F
	7.5	5.5	47	120	AK-R2-120P1K2	32	PV-32ANH1
	10.0	7.5	47	120	AK-R2-120P1K2	32	PV-32ANH1
	15.0	11.0	43	60	AK-R2-120P1K2 <sup>(5)</sup>	50	1000GH-025
	20.0	15.0	43	60	AK-R2-120P1K2 <sup>(5)</sup>	50	1000GH-025
	25.0	18.5	27	40	AK-R2-120P1K2 <sup>(6)</sup>	63	1000GH-040
525...600V 50/60 Hz 3-Phase	0.5	0.4	112	360	AK-R2-360P500	10	PV-10A10F
	1.0	0.75	112	360	AK-R2-360P500	10	PV-10A10F
	2.0	1.5	112	360	AK-R2-360P500	10	PV-10A10F
	3.0	2.2	112	120	AK-R2-120P1K2	10	PV-10A10F
	5.0	4.0	86	120	AK-R2-120P1K2	12	PV-12A10F
	7.5	5.5	59	120	AK-R2-120P1K2	20	PV-20A10F
	10.0	7.5	59	120	AK-R2-120P1K2	20	PV-20A10F
	15.0	11.0	59	60	AK-R2-120P1K2 <sup>(5)</sup>	40	1000GH-025
	20.0	15.0	59	60	AK-R2-120P1K2 <sup>(5)</sup>	40	1000GH-025
	25.0	18.5	53	60	AK-R2-120P1K2 <sup>(5)</sup>	40	1000GH-040
30.0	22.0	34	40	AK-R2-120P1K2 <sup>(6)</sup>	40	1000GH-040	

- (1) The resistors that are listed in this table are rated for 5% duty cycle.
- (2) Use of Rockwell Automation resistors is always recommended. The resistors that are listed have been carefully selected to optimize performance in various applications. Alternative resistors may be used, however, care must be taken when making a selection. See the PowerFlex Dynamic Braking Resistor Calculator Application Technique, publication [PFLEX-AT001](#).
- (3) Connect a 1000V DC fuse links at BR+ terminal in series with the dynamic brake resistor.
- (4) PV-xxxxxx fuses are from Bussman. 1000GH-xxx fuses are from Hinode.
- (5) Requires two resistors that are wired in parallel.
- (6) Requires three resistors that are wired in parallel.

EMC Line Filters

Short-circuit Current Rating = 100 kA						
Drive Ratings				Frame Size	For 100 m Catalog No.	For 150 m <sup>(1)</sup> Catalog No.
Input Voltage	HP	kW	Current (A)			
100...120V 50/60 Hz 1-Phase	0.25	0.2	1.6	A	25-RF011-AL	—
	0.5	0.4	2.5	A	25-RF011-AL	—
	1.0	0.75	4.8	B	25-RF023-BL	—
	1.5	1.1	6.0	B	25-RF023-BL	—

EMC Line Filters (Continued)

Short-circuit Current Rating = 100 kA						
Drive Ratings				Frame Size	For 100 m Catalog No.	For 150 m <sup>(1)</sup> Catalog No.
Input Voltage	HP	kW	Current (A)			
200...240V 50/60 Hz 1-Phase	0.25	0.2	1.6	A	25-RF011-AL	
	0.5	0.4	2.5	A	25-RF011-AL	
	1.0	0.75	4.8	A	25-RF011-AL	
	2.0	1.5	8.0	B	25-RF023-BL	
	3.0	2.2	11.0	B	25-RF023-BL	
200...240V 50/60 Hz 3-Phase	0.25	0.2	1.6	A	25-RF014-AL	25-RF021-BL
	0.5	0.4	2.5	A	25-RF014-AL	25-RF021-BL
	1.0	0.75	5.0	A	25-RF014-AL	25-RF021-BL
	2.0	1.5	8.0	A	25-RF014-AL	25-RF021-BL
	3.0	2.2	11.0	A	25-RF014-AL	25-RF021-BL
	5.0	4.0	17.5	B	25-RF021-BL	
	7.5	5.5	24.0	C	25-RF027-CL	
	10.0	7.5	32.2	D	25-RF035-DL	
	15.0	11.0	48.3	E	25-RF056-EL	
	20.0	15.0	62.1	E	25-RF056-EL	
380...480V 50/60 Hz 3-Phase	0.5	0.4	1.4	A	25-RF7P5-AL	25-RF014-BL
	1.0	0.75	2.3	A	25-RF7P5-AL	25-RF014-BL
	2.0	1.5	4.0	A	25-RF7P5-AL	25-RF014-BL
	3.0	2.2	6.0	A	25-RF7P5-AL	25-RF014-BL
	5.0	4.0	10.5	B	25-RF014-BL	
	7.5	5.5	13.0	C	25-RF018-CL	
	10.0	7.5	17.0	C	25-RF018-CL	
	15.0	11.0	24.0	D	25-RF033-DL	
	20.0	15.0	30.0	D	25-RF033-DL	
	25.0	18.5	37.0	E	25-RF039-EL	
	30.0	22.0	43.0	E	25-RF039-E	
525...600V 50/60 Hz 3-Phase	0.5	0.4	0.9	A	25-RF8P0-BL <sup>(2)</sup>	—
	1.0	0.75	1.7	A	25-RF8P0-BL <sup>(2)</sup>	—
	2.0	1.5	3.0	A	25-RF8P0-BL <sup>(2)</sup>	—
	3.0	2.2	4.2	A	25-RF8P0-BL <sup>(2)</sup>	—
	5.0	4.0	6.6	B	25-RF8P0-BL	—
	7.5	5.5	9.9	C	25-RF014-CL	—
	10.0	7.5	12.0	C	25-RF014-CL	—
	15.0	11.0	19.0	D	25-RF027-DL	—
	20.0	15.0	22.0	D	25-RF027-DL	—
	25.0	18.5	27.0	E	25-RF029-EL	—
30.0	22.0	32.0	E	25-RF029-EL	—	

(1) Requires Series B filters to achieve 150 m rating.  
 (2) The 600V drive rating must be matched with a frame B Line Filter.

EMC Plates

Item	Description	Frame Size	Catalog No.
EMC Plate	Optional grounding plate for shielded cables.	A	25-EMC1-FA
		B	25-EMC1-FB
		C	25-EMC1-FC
		D	25-EMC1-FD
		E	25-EMC1-FE

**IP 30/NEMA 1/UL Type 1 Kit**

Item	Description	Frame Size	Catalog No.
IP 30/NEMA 1/UL Type 1 Kit	Field installed kit. Converts drive to IP 30/NEMA 1/UL Type 1 enclosure. Includes conduit box with mounting screws and plastic top panel.	A	25-JBAA
		B	25-JBAB
		C	25-JBAC
		D	25-JBAD
		E	25-JBAE

**Control Module Fan Kit**

Item	Description	Frame Size	Catalog No.
Control Module Fan Kit	For use with drive in environments with ambient temperatures up to 70 °C or horizontal mounting.	A...D	25-FAN1-70C
		E	25-FAN2-70C

**Incremental Encoder Input Option**

Item	Description	Catalog No.
Incremental Encoder Board	Interface to an external incremental encoder.	25-ENC-2

**Bulletin 160 to PowerFlex 527 Mounting Adapter Plate**

Item	Description	B160 Frame Size	Catalog No.
Mounting Adapter Plate	For use with drive when replacing Bulletin 160 drives in existing installations to a PowerFlex 520-Series drive. Select the catalog number based on the frame size of your Bulletin 160 drive.	A	25-MAP-FA
		B	25-MAP-FB

*Replacement Parts***PowerFlex 527 Power Module**

Item	Description
PowerFlex 527 Power Module	Replacement power module for use with PowerFlex 527 drive. Includes: <ul style="list-style-type: none"> <li>• Power Module</li> <li>• Power Module Front Cover</li> <li>• Power Terminal Guard</li> <li>• Heatsink Fan</li> </ul>

**PowerFlex 527 Power Module**

Output Ratings					Input Voltage Range	Frame Size	Catalog No.
Normal Duty		Heavy Duty		Output Current (A)			
HP	kW	HP	kW				
<b>100...120V AC (-15%, +10%) - 1-Phase Input, 0...230V 3-Phase Output</b>							
0.5	0.4	0.5	0.4	2.5	85...132	A	25-PM1-V2P5
1.0	0.75	1.0	0.75	4.8	85...132	B	25-PM1-V4P8
1.5	1.1	1.5	1.1	6.0	85...132	B	25-PM1-V6P0
<b>200...240V AC (-15%, +10%) - 1-Phase Input, 0...230V 3-Phase Output</b>							
0.5	0.4	0.5	0.4	2.5	170...264	A	25-PM1-A2P5
1.0	0.75	1.0	0.75	4.8	170...264	A	25-PM1-A4P8
2.0	1.5	2.0	1.5	8.0	170...264	B	25-PM1-A8P0
3.0	2.2	3.0	2.2	11.0	170...264	B	25-PM1-A011
<b>200...240V AC (-15%, +10%) - 1-Phase Input with EMC Filter, 0...230V 3-Phase Output</b>							
0.5	0.4	0.5	0.4	2.5	170...264	A	25-PM2-A2P5
1.0	0.75	1.0	0.75	4.8	170...264	A	25-PM2-A4P8

## PowerFlex 527 Power Module (Continued)

Output Ratings					Input Voltage Range	Frame Size	Catalog No.
Normal Duty		Heavy Duty		Output Current (A)			
HP	kW	HP	kW				
2.0	1.5	2.0	1.5	8.0	170...264	B	25-PM2-A8P0
3.0	2.2	3.0	2.2	11.0	170...264	B	25-PM2-A011
<b>200...240V AC (-15%, +10%) - 3-Phase Input, 0...230V 3-Phase Output</b>							
0.5	0.4	0.5	0.4	2.5	170...264	A	25-PM1-B2P5
1.0	0.75	1.0	0.75	5.0	170...264	A	25-PM1-B5P0
2.0	1.5	2.0	1.5	8.0	170...264	A	25-PM1-B8P0
3.0	2.2	3.0	2.2	11.0	170...264	A	25-PM1-B011
5.0	4.0	5.0	4.0	17.5	170...264	B	25-PM1-B017
7.5	5.5	7.5	5.5	24.0	170...264	C	25-PM1-B024
10.0	7.5	10.0	7.5	32.2	170...264	D	25-PM1-B032
15.0	11.0	10.0	7.5	48.3	170...264	E	25-PM1-B048
20.0	15.0	15.0	11.0	62.1	170...264	E	25-PM1-B062
<b>380...480V AC (-15%, +10%) - 3-Phase Input, 0...460V 3-Phase Output</b>							
0.5	0.4	0.5	0.4	1.4	323...528	A	25-PM1-D1P4
1.0	0.75	1.0	0.75	2.3	323...528	A	25-PM1-D2P3
2.0	1.5	2.0	1.5	4.0	323...528	A	25-PM1-D4P0
3.0	2.2	3.0	2.2	6.0	323...528	A	25-PM1-D6P0
5.0	4.0	5.0	4.0	10.5	323...528	B	25-PM1-D010
7.5	5.5	7.5	5.5	13.0	323...528	C	25-PM1-D013
10.0	7.5	10.0	7.5	17.0	323...528	C	25-PM1-D017
15.0	11.0	15.0	11.0	24.0	323...528	D	25-PM1-D024
20.0	15.0	15.0	11.0	30.0	323...528	D	25-PM1-D030
<b>380...480V AC (-15%, +10%) - 3-Phase Input with EMC Filter, 0...460V 3-Phase Output</b>							
0.5	0.4	0.5	0.4	1.4	323...528	A	25-PM2-D1P4
1.0	0.75	1.0	0.75	2.3	323...528	A	25-PM2-D2P3
2.0	1.5	2.0	1.5	4.0	323...528	A	25-PM2-D4P0
3.0	2.2	3.0	2.2	6.0	323...528	A	25-PM2-D6P0
5.0	4.0	5.0	4.0	10.5	323...528	B	25-PM2-D010
7.5	5.5	7.5	5.5	13.0	323...528	C	25-PM2-D013
10.0	7.5	10.0	7.5	17.0	323...528	C	25-PM2-D017
15.0	11.0	15.0	11.0	24.0	323...528	D	25-PM2-D024
20.0	15.0	15.0	11.0	30.0	323...528	D	25-PM2-D030
25.0	18.5	20.0	15.0	37.0	323...528	E	25-PM2-D037
30.0	22.0	25.0	18.5	43.0	323...528	E	25-PM2-D043
<b>525...600V AC (-15%, +10%) - 3-Phase Input, 0...575V 3-Phase Output</b>							
0.5	0.4	0.5	0.4	0.9	446...660	A	25-PM1-E0P9
1.0	0.75	1.0	0.75	1.7	446...660	A	25-PM1-E1P7
2.0	1.5	2.0	1.5	3.0	446...660	A	25-PM1-E3P0
3.0	2.2	3.0	2.2	4.2	446...660	A	25-PM1-E4P2
5.0	4.0	5.0	4.0	6.6	446...660	B	25-PM1-E6P6
7.5	5.5	7.5	5.5	9.9	446...660	C	25-PM1-E9P9
10.0	7.5	10.0	7.5	12.0	446...660	C	25-PM1-E012
15.0	11.0	15.0	11.0	19.0	446...660	D	25-PM1-E019
20.0	15.0	15.0	11.0	22.0	446...660	D	25-PM1-E022
25.0	18.5	20.0	15.0	27.0	446...660	E	25-PM1-E027
30.0	22.0	25.0	18.5	32.0	446...660	E	25-PM1-E032

**PowerFlex 527 Control Module**

Item	Description	Frame Size	Catalog No.
PowerFlex 527 Control Module	Replacement control module for use with PowerFlex 527 drives. Includes: <ul style="list-style-type: none"> <li>Control Module</li> <li>Control Module Front Cover</li> </ul>	A...E	25C-CTM1

**Other Parts**

Item	Description	Frame Size	Catalog No.
PowerFlex 527 Control Module Front Cover	Replacement cover for the control module I/O terminals and EtherNet/IP ports.	A...E	25C-CTMFC1
PowerFlex 520-Series Power Module Front Cover	Replacement cover for the PowerFlex 520-Series power module.	B	25-PMFC-FB
		C	25-PMFC-FC
		D	25-PMFC-FD
		E	25-PMFC-FE
PowerFlex 520-Series Power Terminal Guard	Replacement finger guard for power terminals.	A	25-PTG1-FA
		B	25-PTG1-FB
		C	25-PTG1-FC
		D	25-PTG1-FD
		E	25-PTG1-FE
PowerFlex 527 Removable Terminal Blocks Kit	Replacement terminal blocks for control wiring.	A...E	25C-RCTB
PowerFlex 527 Control Module Internal Fan Kit	Replacement internal fan for the control module.	A...E	25C-FAN2-INT
PowerFlex 520-Series Heatsink Fan Kit	Replacement fan for drive power module.	A	25-FAN1-FA
		B	25-FAN1-FB
		C	25-FAN1-FC
		D	25-FAN1-FD
		E	25-FAN1-FE

**Bulletin 1321-3R Series Line Reactors**

Output Ratings <sup>(1)</sup>				Input Line Reactor <sup>(2)(3)</sup>		Output Line Reactor	
Normal Duty		Heavy Duty		IP00 (Open Style)	IP11 (NEMA/UL Type 1)	IP00 (Open Style)	IP11 (NEMA/UL Type 1)
HP	kW	HP	kW	Catalog No.	Catalog No.	Catalog No.	Catalog No.
<b>200...240V 50/60 Hz 1-Phase<sup>(4)</sup></b>							
0.25	0.2	0.25	0.2	1321-3R4-A	1321-3RA4-A	1321-3R2-D	1321-3RA2-D
0.5	0.4	0.5	0.4	1321-3R8-A	1321-3RA8-A	1321-3R2-D	1321-3RA2-D
1.0	0.75	1.0	0.75	1321-3R8-A	1321-3RA8-A	1321-3R4-A	1321-3RA4-A
2.0	1.5	2.0	1.5	1321-3R18-A	1321-3RA18-A	1321-3R8-A	1321-3RA8-A
3.0	2.2	3.0	2.2	1321-3R18-A	1321-3RA18-A	1321-3R12-A	1321-3RA12-A
<b>200...240V 50/60 Hz 3-Phase</b>							
0.25	0.2	0.25	0.2	1321-3R2-D	1321-3RA2-D	1321-3R2-D	1321-3RA2-D
0.5	0.4	0.5	0.4	1321-3R2-D	1321-3RA2-D	1321-3R2-D	1321-3RA2-D
1.0	0.75	1.0	0.75	1321-3R4-A	1321-3RA4-A	1321-3R4-A	1321-3RA4-A
2.0	1.5	2.0	1.5	1321-3R8-A	1321-3RA8-A	1321-3R8-A	1321-3RA8-A
3.0	2.2	3.0	2.2	1321-3R12-A	1321-3RA12-A	1321-3R12-A	1321-3RA12-A
5.0	4.0	5.0	4.0	1321-3R18-A	1321-3RA18-A	1321-3R18-A	1321-3RA18-A
7.5	5.5	7.5	5.5	1321-3R25-A	1321-3RA25-A	1321-3R25-A	1321-3RA25-A
10.0	7.5	10.0	7.5	1321-3R35-A	1321-3RA35-A	1321-3R35-A	1321-3RA35-A
15.0	11.0	10.0	7.5	1321-3R45-A	1321-3RA45-A	1321-3R45-A	1321-3RA45-A

Bulletin 1321-3R Series Line Reactors (Continued)

Output Ratings <sup>(1)</sup>				Input Line Reactor <sup>(2)(3)</sup>		Output Line Reactor	
Normal Duty		Heavy Duty		IP00 (Open Style)	IP11 (NEMA/UL Type 1)	IP00 (Open Style)	IP11 (NEMA/UL Type 1)
HP	kW	HP	kW	Catalog No.	Catalog No.	Catalog No.	Catalog No.
20.0	15.0	15.0	11.0	1321-3R55-A (ND) 1321-3R45-A (HD)	1321-3RA55-A (ND) 1321-3RA45-A (HD)	1321-3R55-A (ND) 1321-3R45-A (HD)	1321-3RA55-A (ND) 1321-3RA45-A (HD)
<b>380...480V 50/60 Hz 3-Phase</b>							
0.5	0.4	0.5	0.4	1321-3R2-B	1321-3RA2-B	1321-3R2-B	1321-3RA2-B
1.0	0.75	1.0	0.75	1321-3R4-C	1321-3RA4-C	1321-3R4-C	1321-3RA4-C
2.0	1.5	2.0	1.5	1321-3R4-B	1321-3RA4-B	1321-3R4-B	1321-3RA4-B
3.0	2.2	3.0	2.2	1321-3R8-C	1321-3RA8-C	1321-3R8-C	1321-3RA8-C
5.0	4.0	5.0	4.0	1321-3R12-B	1321-3RA12-B	1321-3R12-B	1321-3RA12-B
7.5	5.5	7.5	5.5	1321-3R12-B	1321-3RA12-B	1321-3R12-B	1321-3RA12-B
10.0	7.5	10.0	7.5	1321-3R18-B	1321-3RA18-B	1321-3R18-B	1321-3RA18-B
15.0	11.0	15.0	11.0	1321-3R25-B	1321-3RA25-B	1321-3R25-B	1321-3RA25-B
20.0	15.0	15.0	11.0	1321-3R35-B (ND) 1321-3R25-B (HD)	1321-3RA35-B (ND) 1321-3RA25-B (HD)	1321-3R35-B (ND) 1321-3R25-B (HD)	1321-3RA35-B (ND) 1321-3RA25-B (HD)
25.0	18.5	20.0	15.0	1321-3R35-B	1321-3RA35-B	1321-3R35-B	1321-3RA35-B
30.0	22.0	25.0	18.5	1321-3R45-B (ND) 1321-3R35-B (HD)	1321-3RA45-B (ND) 1321-3RA35-B (HD)	1321-3R45-B (ND) 1321-3R35-B (HD)	1321-3RA45-B (ND) 1321-3RA35-B (HD)
<b>525...600V 50/60 Hz 3-Phase</b>							
0.5	0.4	0.5	0.4	1321-3R1-C	1321-3RA1-C	1321-3R1-C	1321-3RA1-C
1.0	0.75	1.0	0.75	1321-3R2-B	1321-3RA2-B	1321-3R2-B	1321-3RA2-B
2.0	1.5	2.0	1.5	1321-3R4-C	1321-3RA4-C	1321-3R4-C	1321-3RA4-C
3.0	2.2	3.0	2.2	1321-3R4-B	1321-3RA4-B	1321-3R4-B	1321-3RA4-B
5.0	4.0	5.0	4.0	1321-3R8-C	1321-3RA8-C	1321-3R8-C	1321-3RA8-C
7.5	5.5	7.5	5.5	1321-3R12-B	1321-3RA12-B	1321-3R12-B	1321-3RA12-B
10.0	7.5	10.0	7.5	1321-3R12-B	1321-3RA12-B	1321-3R12-B	1321-3RA12-B
15.0	11.0	15.0	11.0	1321-3R18-B	1321-3RA18-B	1321-3R18-B	1321-3RA18-B
20.0	15.0	15.0	11.0	1321-3R25-B (ND) 1321-3R18-B (HD)	1321-3RA25-B (ND) 1321-3RA18-B (HD)	1321-3R25-B (ND) 1321-3R18-B (HD)	1321-3RA25-B (ND) 1321-3RA18-B (HD)
25.0	18.5	20.0	15.0	1321-3R35-C (ND) 1321-3R25-C (HD)	1321-3RA35-C (ND) 1321-3RA25-C (HD)	1321-3R35-C (ND) 1321-3R25-C (HD)	1321-3RA35-C (ND) 1321-3RA25-C (HD)
30.0	22.0	25.0	18.5	1321-3R35-C (ND) 1321-3R25-B (HD)	1321-3RA35-C (ND) 1321-3RA25-B (HD)	1321-3R35-C (ND) 1321-3R25-B (HD)	1321-3RA35-C (ND) 1321-3RA25-B (HD)

- (1) Normal Duty and Heavy Duty ratings for 15 HP (11 kW) and below are identical except for 200...240V 3-Phase 15 HP (11 kW) drive.
- (2) Catalog numbers that are listed are for 3% impedance at 60 Hz. 5% impedance reactor types are also available. See the 1321 Power Conditioning Products Technical Data, publication [1321-TD001](#).
- (3) Input line reactors were sized based on the NEC fundamental motor amps. Output line reactors were sized based on the VFD rated output currents.
- (4) Standard 3-phase reactors can be used for 1-phase applications by routing each of the two supply conductors through an outside coil and leaving the center open.

## Product Dimensions

The PowerFlex 527 drive is available in five frame sizes. See the [PowerFlex 527 Drive Ratings on page 137](#) for information on power ratings.

### PowerFlex 527 Drive Weight

Frame Size	Weight (kg/lb)
A	1.1 / 2.4
B	1.6 / 3.5
C	2.3 / 5.0
D	3.9 / 8.6
E	12.9 / 28.4

### IP 20/Open Type - Frame A

Dimensions are in millimeters and (inches)

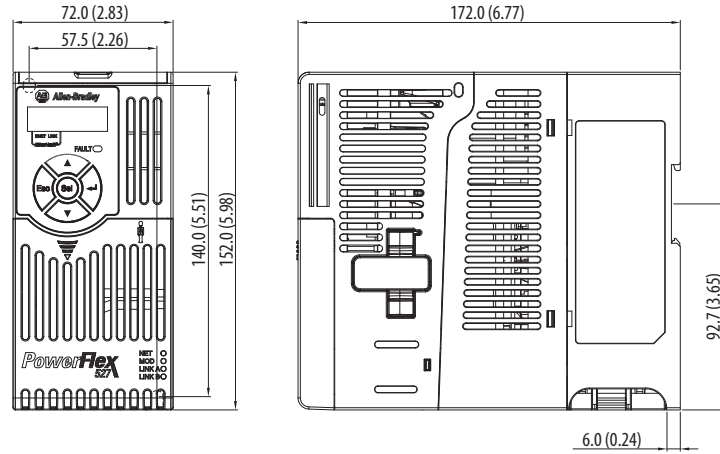

### IP 20/Open Type - Frame B

Dimensions are in millimeters and (inches)

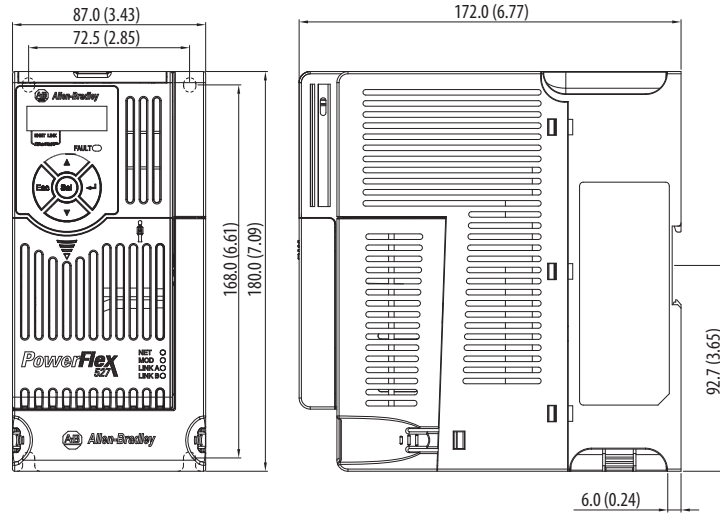

### IP 20/Open Type – Frame C

Dimensions are in millimeters and (inches)

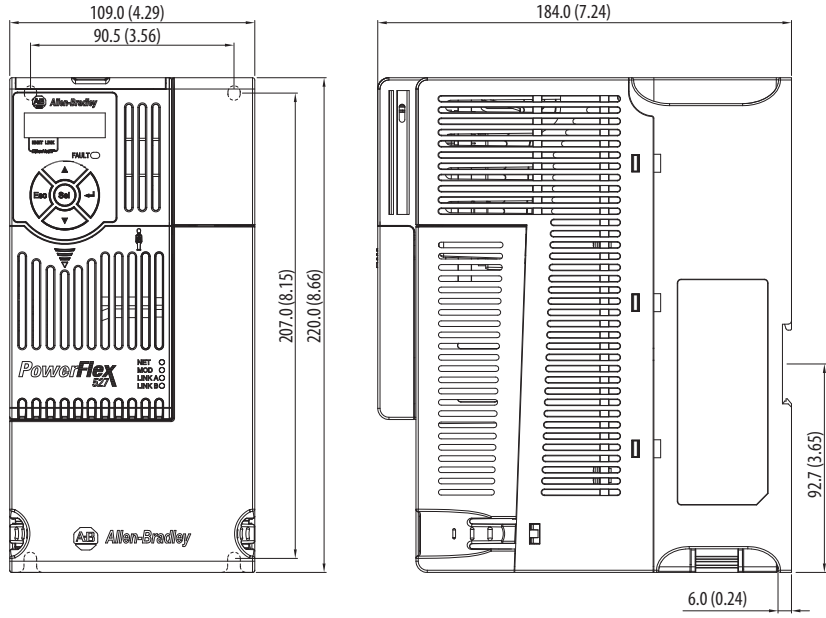

### IP 20/Open Type – Frame D

Dimensions are in millimeters and (inches)

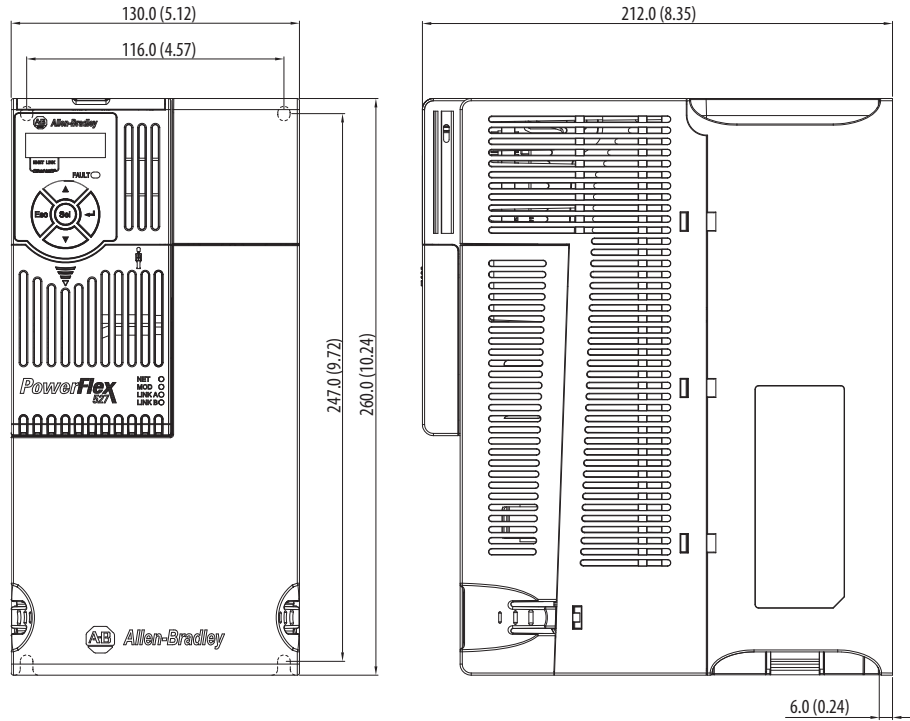



### IP 20/Open Type - Frame E

Dimensions are in millimeters and (inches)

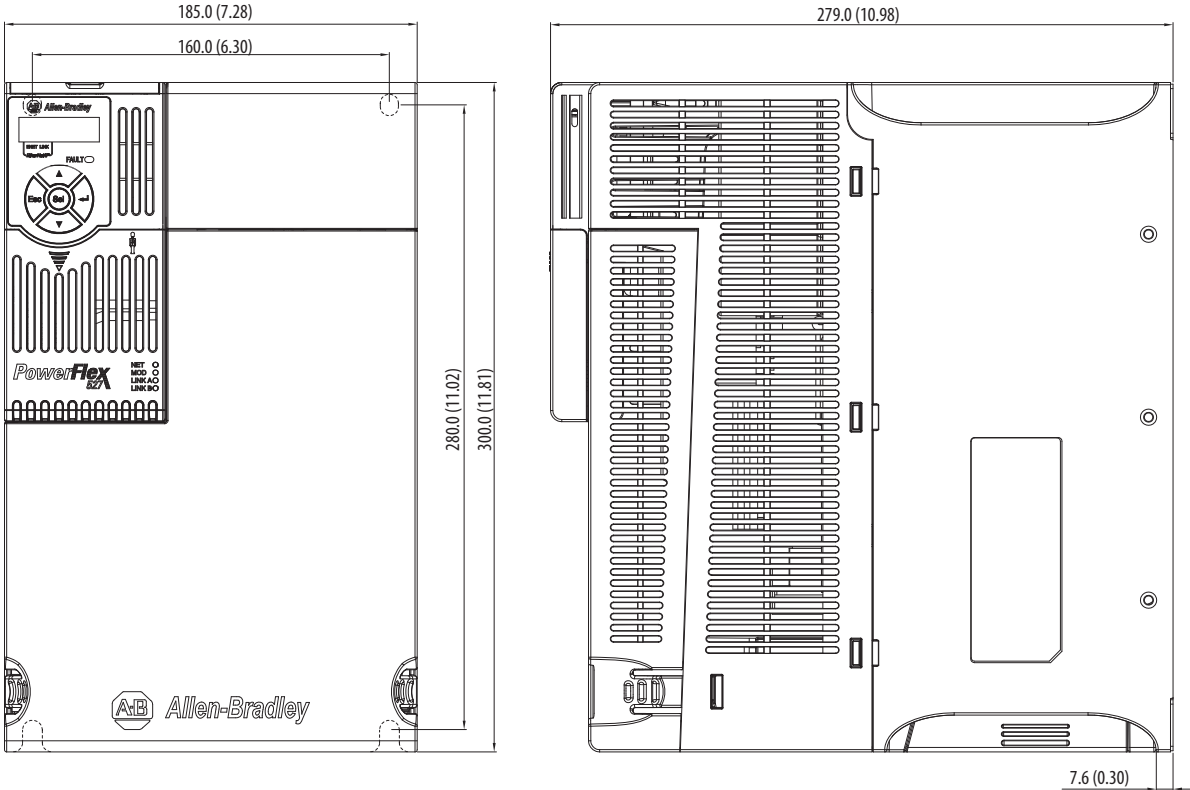

Control Module Fan Kit

25-FAN1-70C

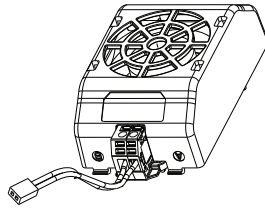

25-FAN2-70C

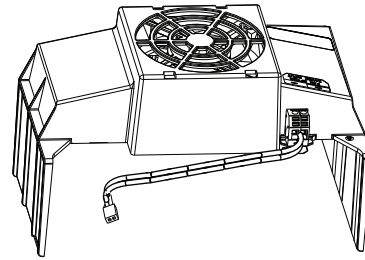

Specifications	25-FAN1-70C	25-FAN2-70C
Rated Voltage	24V DC	
Operation Voltage	14...27.6V DC	
Input Current	0.1 A	0.15 A
Speed (Reference)	7000 rpm	4500 ± 10% rpm
Maximum Air Flow (At zero static pressure)	0.575 m <sup>3</sup> /min	1.574 m <sup>3</sup> /min
Maximum Air Pressure (At zero air flow)	7.70 mmH <sub>2</sub> O	9.598 mmH <sub>2</sub> O
Acoustical Noise	40.5 dBA	46.0 dBA
Insulation Type	UL Class A	
Frame Size	Frame A...D	Frame E
Wire Size	0.32 mm <sup>2</sup> (22 AWG)	
Torque	0.29...0.39 N•m (2.6...3.47 lb•in)	

IP 20/Open Type with Control Module Fan Kit – Frame A...C

Dimensions are in millimeters and (inches)

Frame A

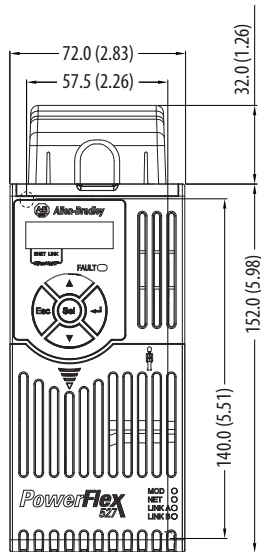

Frame B

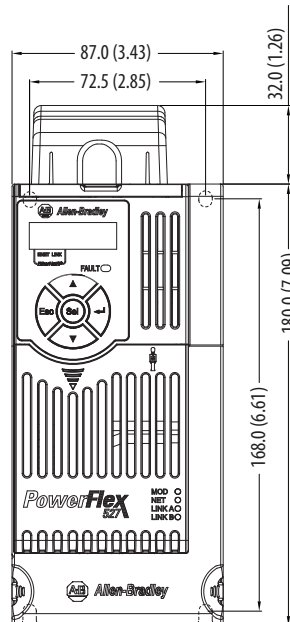

Frame C

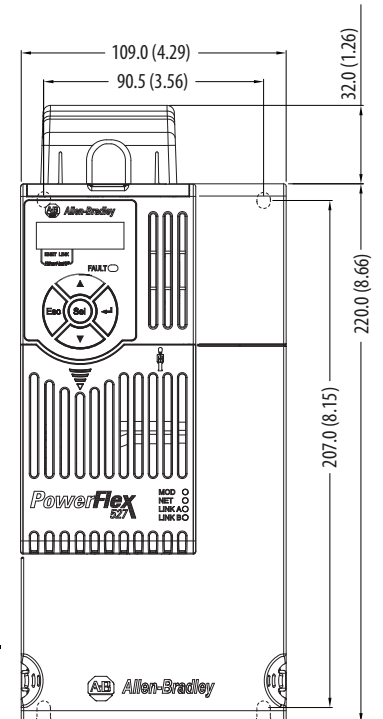

**IMPORTANT** An external 24V DC power source is required when using the Control Module Fan Kit with drive frames A, B, and C.

IP 20/Open Type with Control Module Fan Kit - Frame D...E

Dimensions are in millimeters and (inches)

Frame D

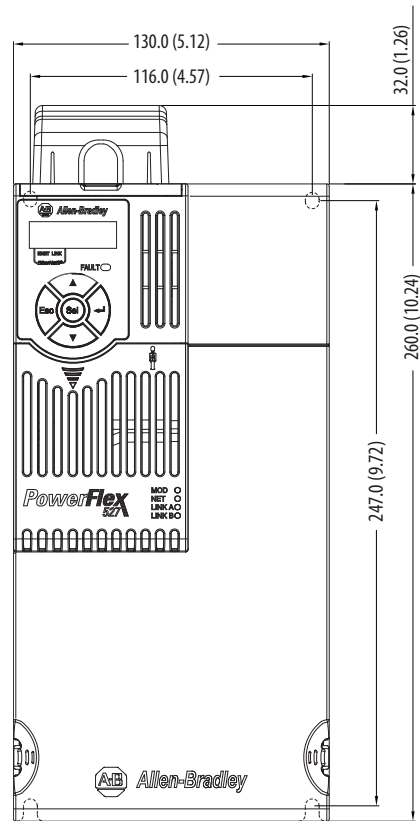

Frame E

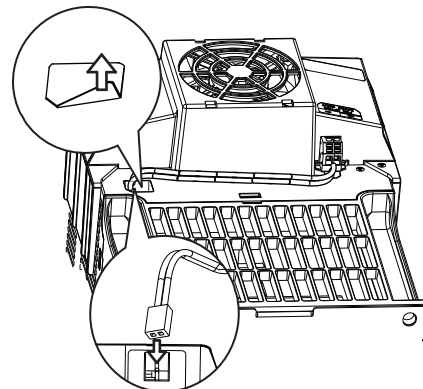
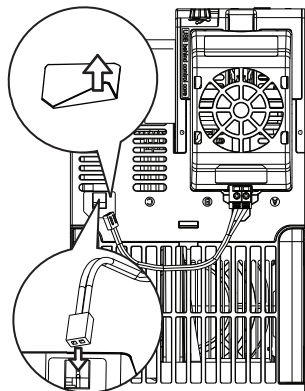
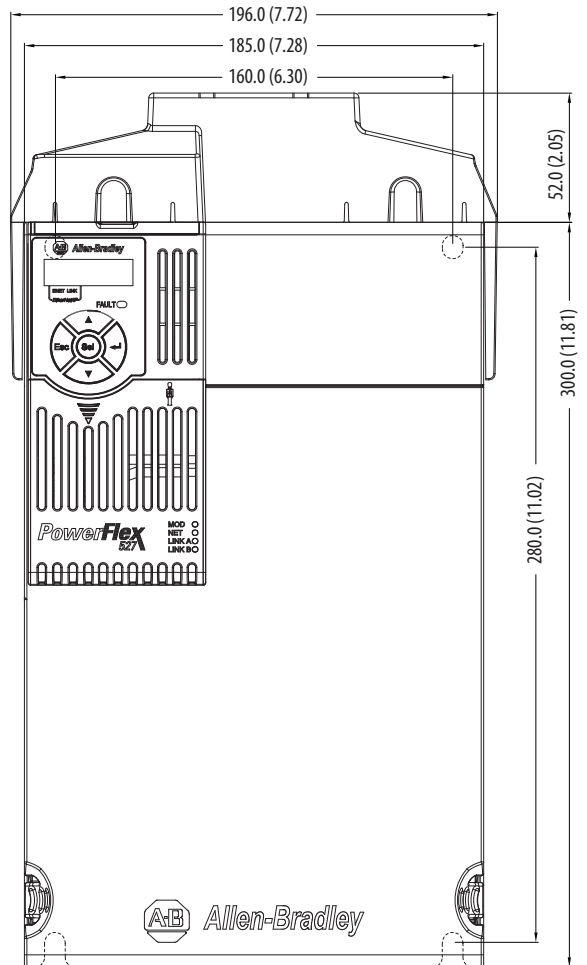

**IMPORTANT** Remove the label to access the built-in 24V supply on drive frames D and E for use with the Control Module Fan Kit.

IP 30/NEMA 1/UL Type 1 - Frame A

Dimensions are in millimeters and (inches)

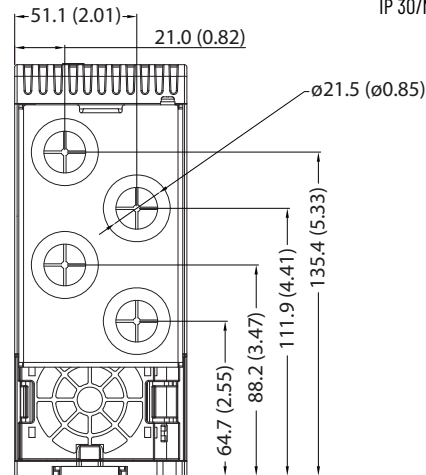
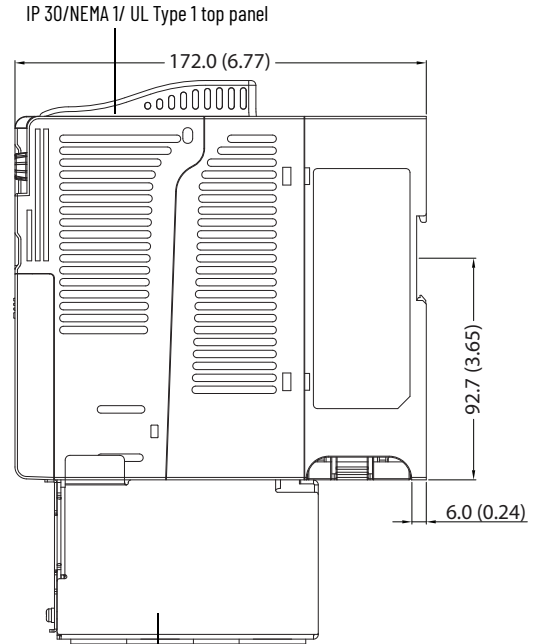
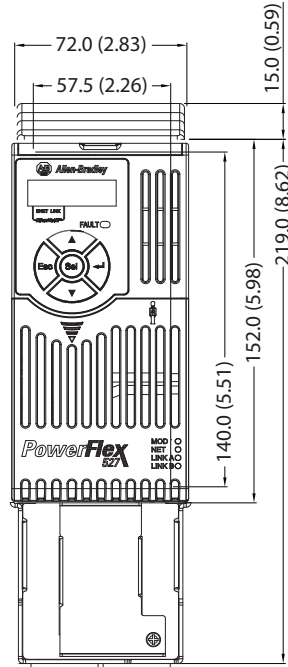

IP 30/NEMA 1/ UL Type 1 conduit box

**IP 30/NEMA 1/UL Type 1 - Frame B**

Dimensions are in millimeters and (inches)

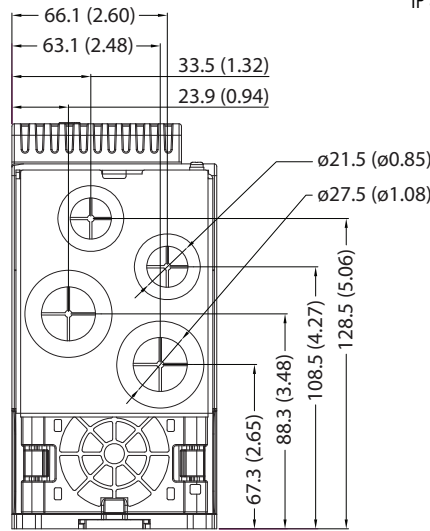
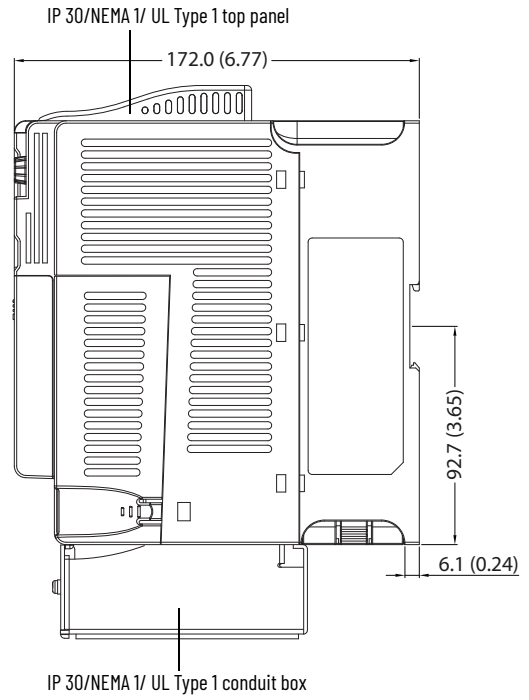
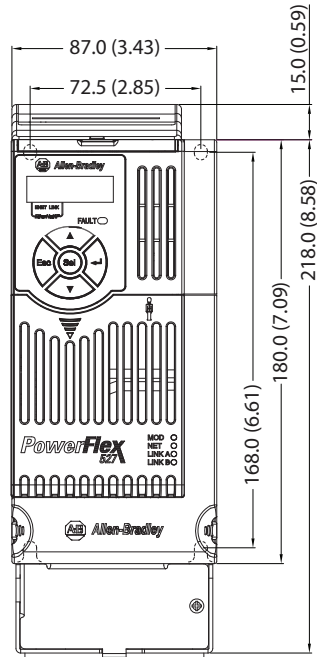

IP 30/NEMA 1/UL Type 1 - Frame C

Dimensions are in millimeters and (inches)

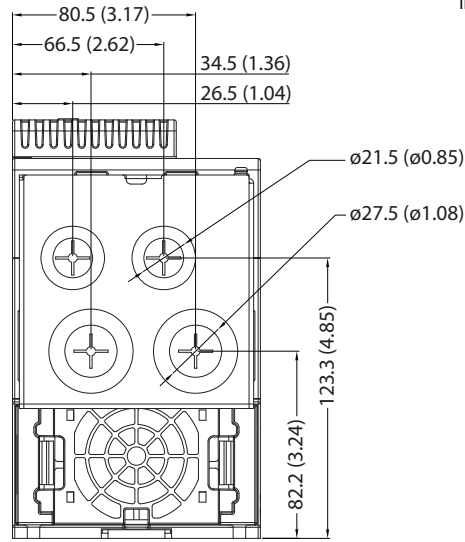
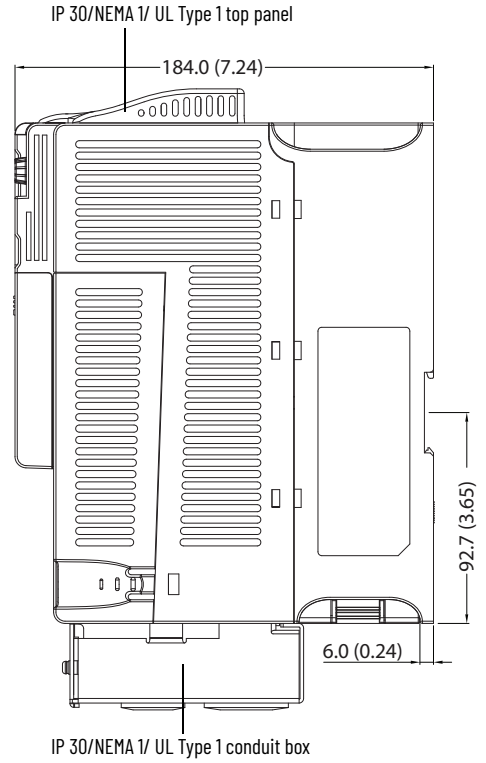
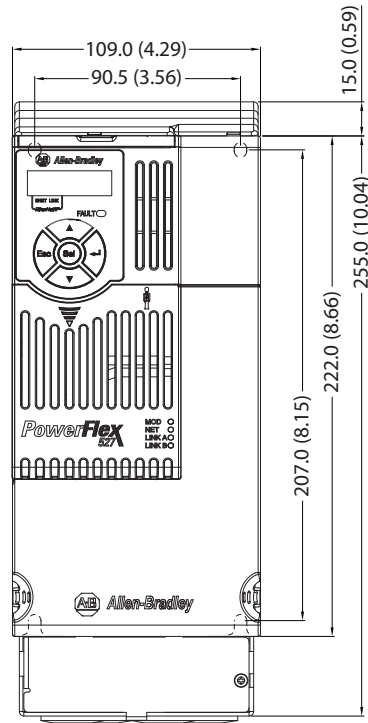

IP 30/NEMA 1/UL Type 1 - Frame D

Dimensions are in millimeters and (inches)

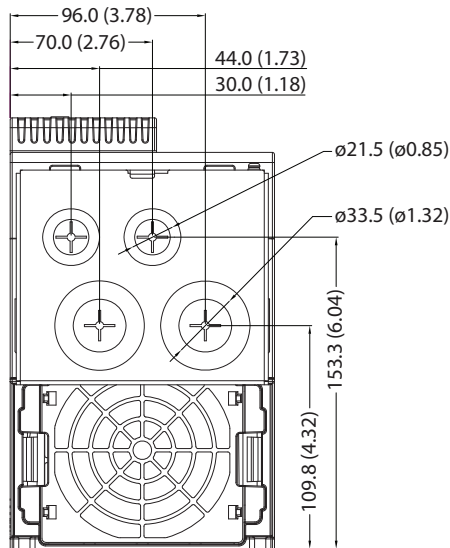
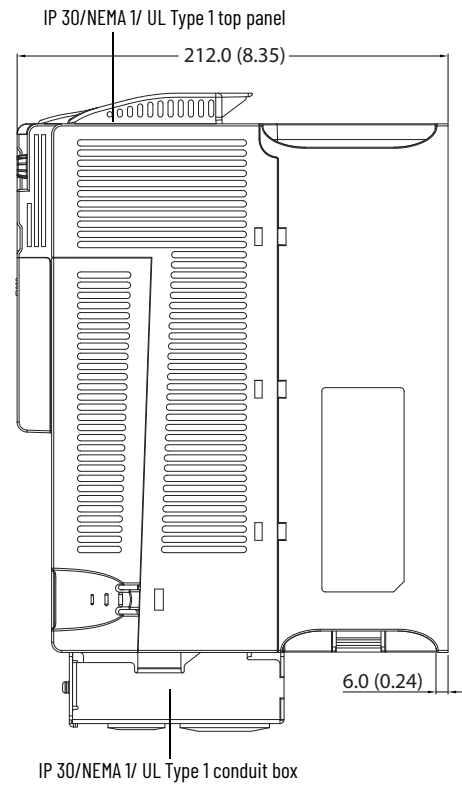
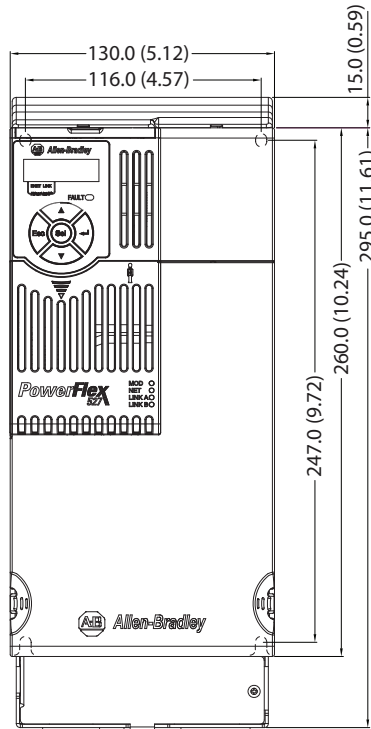

**IP 30/NEMA 1/UL Type 1 - Frame E**

Dimensions are in millimeters and (inches)

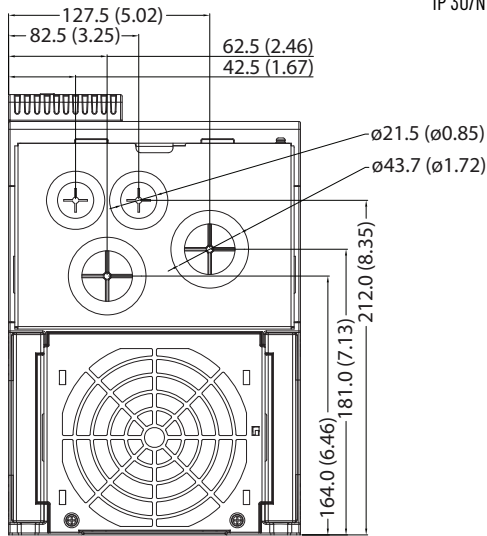
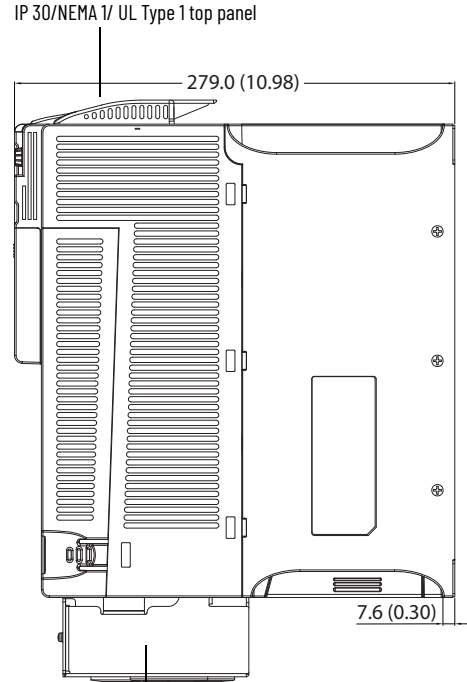
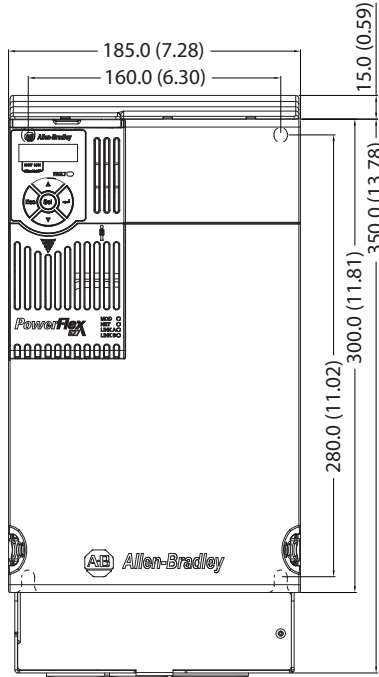



**EMC Line Filter – Frame A**

Dimensions are in millimeters and (inches)

Filter can be mounted onto the back of the drive.

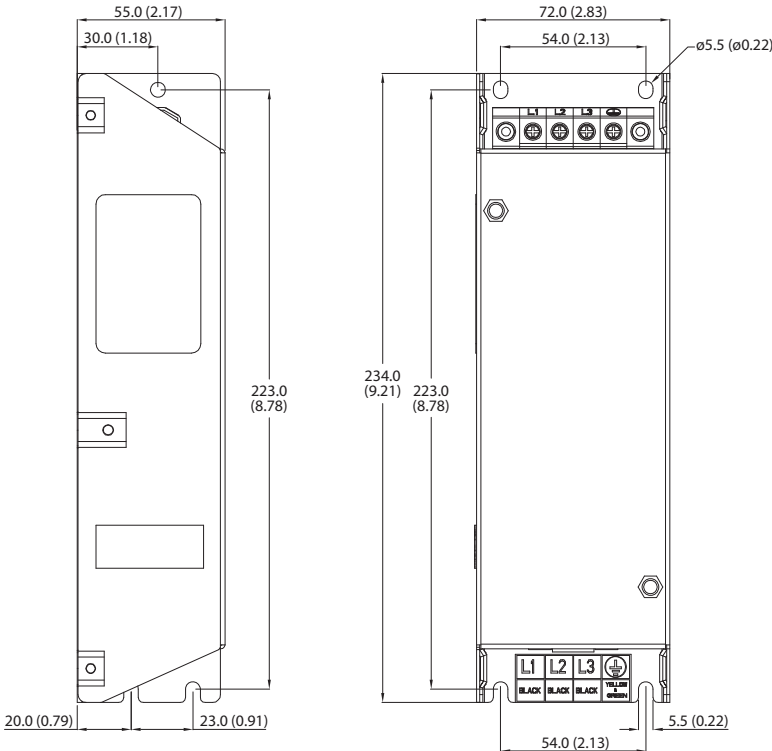

**EMC Line Filter – Frame B**

Dimensions are in millimeters and (inches)

Filter can be mounted onto the back of the drive.

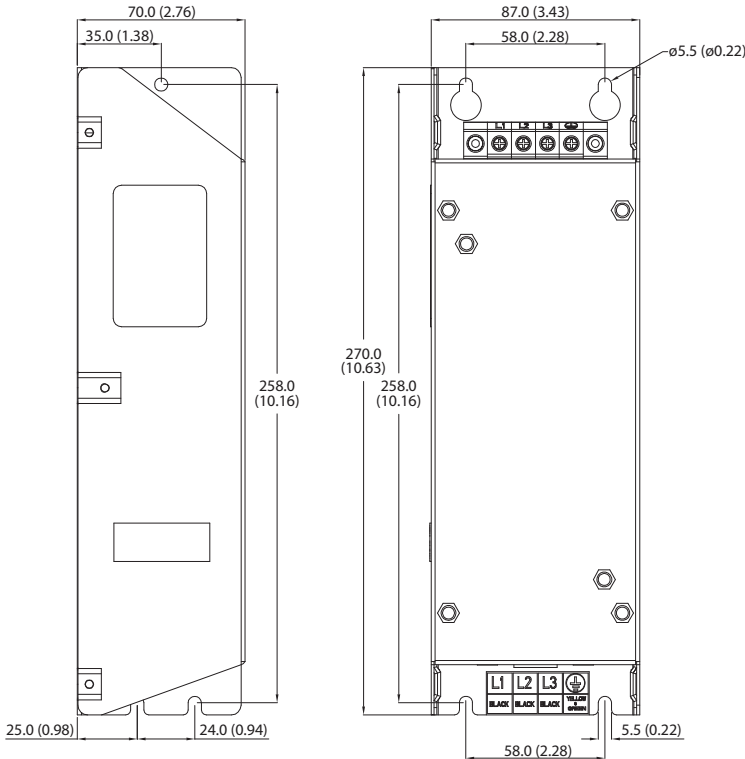

### EMC Line Filter – Frame C

Dimensions are in millimeters and (inches)

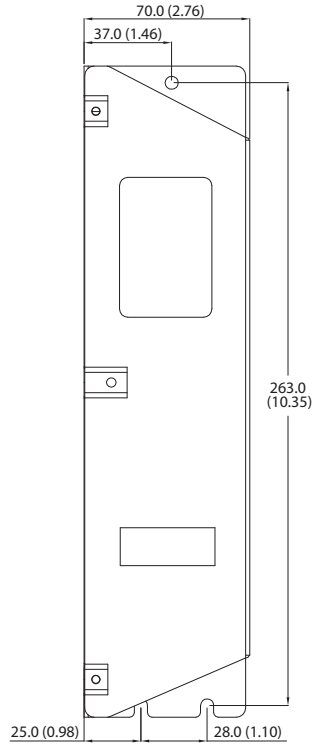

Filter can be mounted onto the back of the drive.

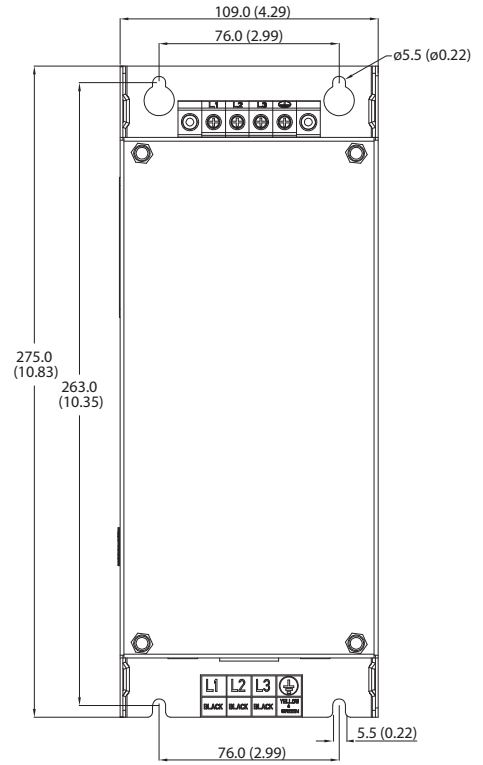

### EMC Line Filter – Frame D

Dimensions are in millimeters and (inches)

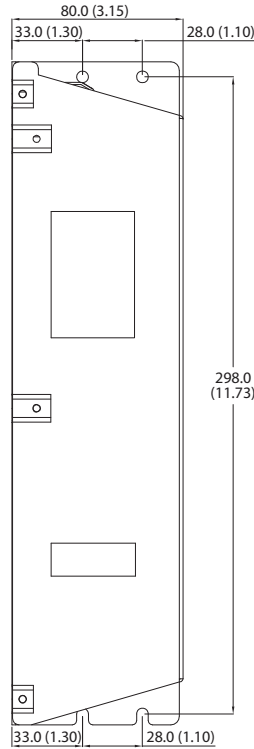

Filter can be mounted onto the back of the drive.

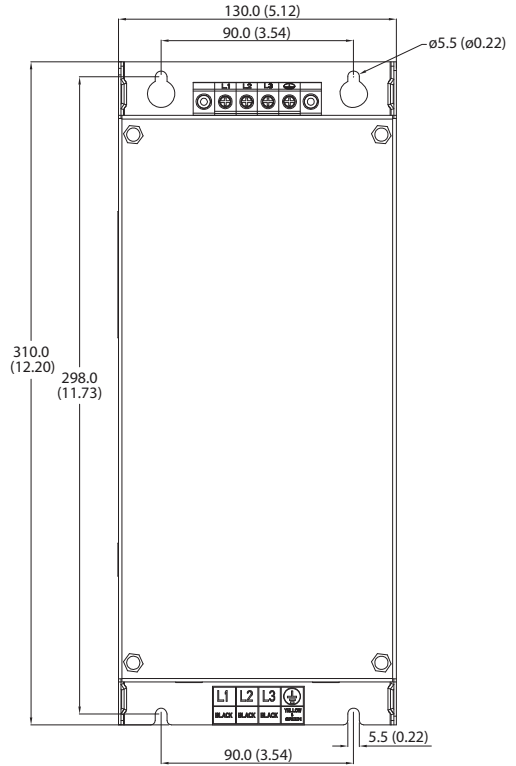

## EMC Line Filter – Frame E

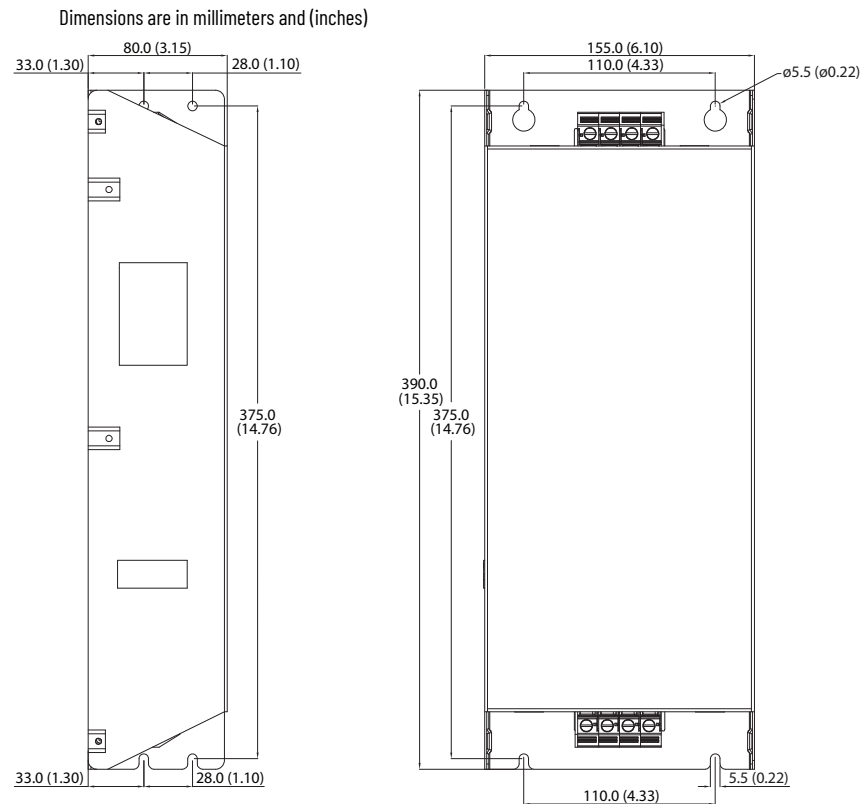

## Replacing the PowerFlex 527 Control Module Internal Fan

To replace the internal fan, you must separate the control module from the power module. Do not perform this operation while the drive is running. See the PowerFlex 527 Control Module Internal Fan Kit Installation Instructions, publication [520-IN014](#) for detailed instructions.

**ATTENTION:**

- Temperature inside the control module may exceed 80 °C (176 °F) when the internal fan is not working. Wait for the control module to cool down before replacing the internal fan.
- Take caution when replacing the internal fan as static damage may occur to sensitive components inside the drive.

**Notes:**

# Out-of-Box Configuration

This section describes the recommended settings for configuring your PowerFlex 527 drive to obtain the best performance from the drive. You should apply these out-of-box settings first before configuring for your application.

## Recommended Out-of-Box Settings

### Out-of-Box Settings

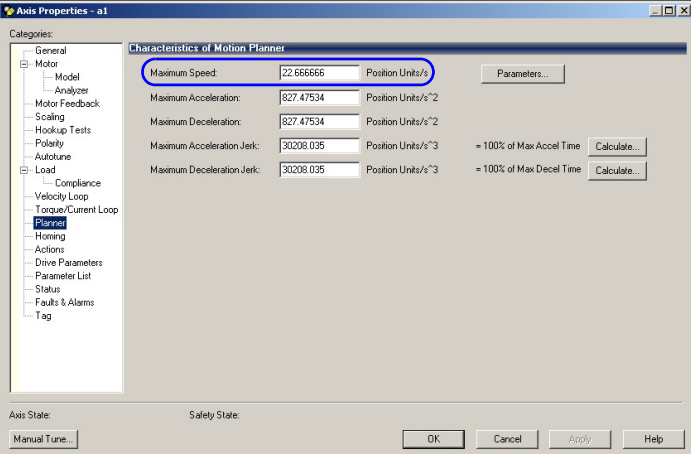
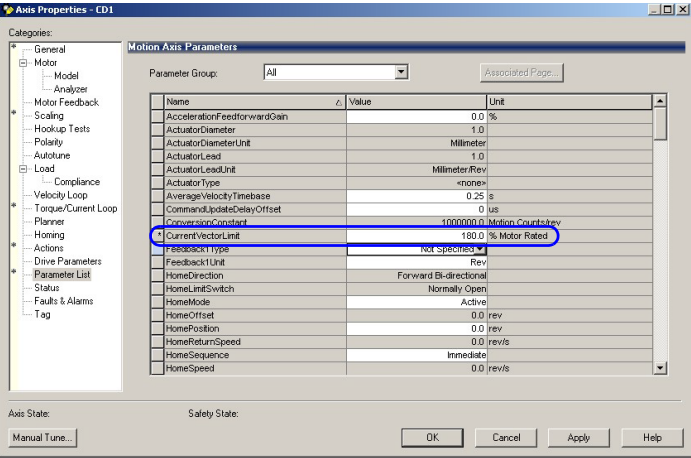
Setting in Logix Designer	Example	Recommended Configuration
Ramp Velocity Limits		120% of Motor Rated Speed for induction motors
Current Vector Limit		180% of Motor Rated Current

Out-of-Box Settings (Continued)

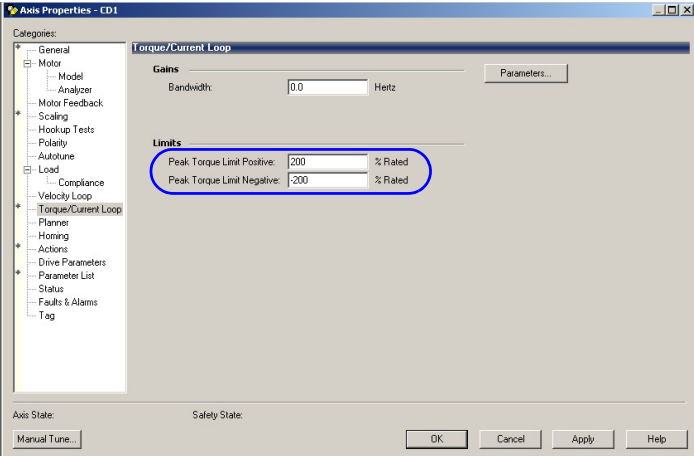
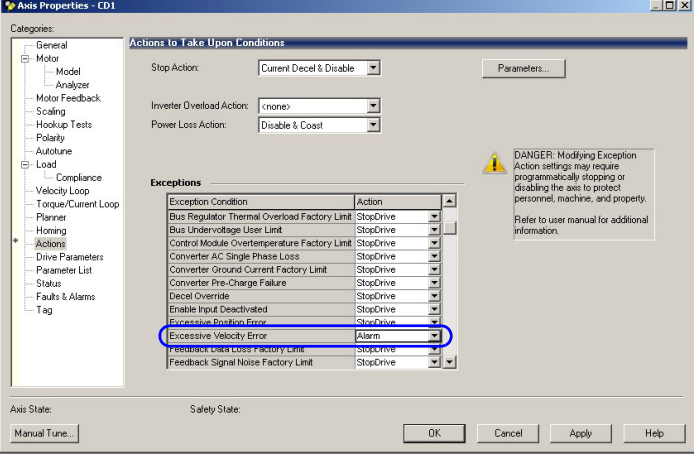
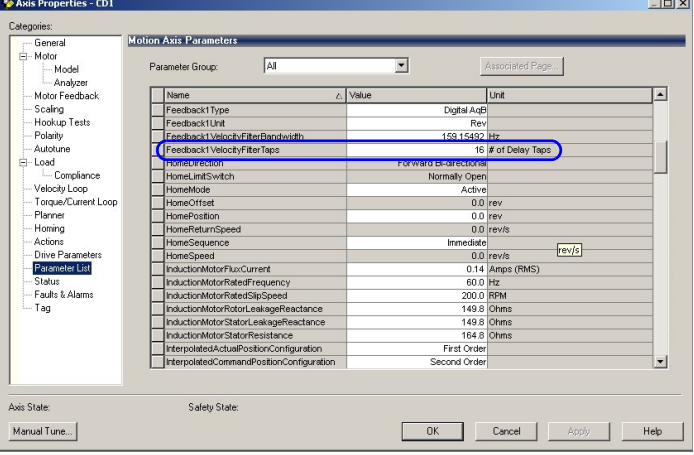
Setting in Logix Designer	Example	Recommended Configuration																																																															
Torque Limits	 <p>The screenshot shows the 'Torque/Current Loop' tab in the 'Axis Properties - CD1' dialog. Under the 'Limits' section, 'Peak Torque Limit Positive' and 'Peak Torque Limit Negative' are both set to '200' with a unit of '% Rated'.</p>	200% of Motor Rated Torque																																																															
Velocity Error Tolerance	 <p>The screenshot shows the 'Actions to Take Upon Conditions' tab. In the 'Exceptions' table, 'Excessive Velocity Error' is highlighted with a blue circle and has 'Alarm' selected in the 'Action' column.</p> <table border="1" data-bbox="560 871 860 1060"> <thead> <tr> <th>Exception Condition</th> <th>Action</th> </tr> </thead> <tbody> <tr><td>Bus Regulator Thermal Overload Factory Limit</td><td>StopDrive</td></tr> <tr><td>Bus Undervoltage User Limit</td><td>StopDrive</td></tr> <tr><td>Control Module Overtemperature Factory Limit</td><td>StopDrive</td></tr> <tr><td>Converter AC Single Phase Loss</td><td>StopDrive</td></tr> <tr><td>Converter Ground Current Factory Limit</td><td>StopDrive</td></tr> <tr><td>Converter Pre-Charge Failure</td><td>StopDrive</td></tr> <tr><td>Decel Override</td><td>StopDrive</td></tr> <tr><td>Enable Input Deactivated</td><td>StopDrive</td></tr> <tr><td>Excessive Position Error</td><td>StopDrive</td></tr> <tr><td><b>Excessive Velocity Error</b></td><td><b>Alarm</b></td></tr> <tr><td>Feedback Data Loss Factory Limit</td><td>StopDrive</td></tr> <tr><td>Feedback Signal Noise Factory Limit</td><td>StopDrive</td></tr> </tbody> </table>	Exception Condition	Action	Bus Regulator Thermal Overload Factory Limit	StopDrive	Bus Undervoltage User Limit	StopDrive	Control Module Overtemperature Factory Limit	StopDrive	Converter AC Single Phase Loss	StopDrive	Converter Ground Current Factory Limit	StopDrive	Converter Pre-Charge Failure	StopDrive	Decel Override	StopDrive	Enable Input Deactivated	StopDrive	Excessive Position Error	StopDrive	<b>Excessive Velocity Error</b>	<b>Alarm</b>	Feedback Data Loss Factory Limit	StopDrive	Feedback Signal Noise Factory Limit	StopDrive	Change Action to Alarm																																					
Exception Condition	Action																																																																
Bus Regulator Thermal Overload Factory Limit	StopDrive																																																																
Bus Undervoltage User Limit	StopDrive																																																																
Control Module Overtemperature Factory Limit	StopDrive																																																																
Converter AC Single Phase Loss	StopDrive																																																																
Converter Ground Current Factory Limit	StopDrive																																																																
Converter Pre-Charge Failure	StopDrive																																																																
Decel Override	StopDrive																																																																
Enable Input Deactivated	StopDrive																																																																
Excessive Position Error	StopDrive																																																																
<b>Excessive Velocity Error</b>	<b>Alarm</b>																																																																
Feedback Data Loss Factory Limit	StopDrive																																																																
Feedback Signal Noise Factory Limit	StopDrive																																																																
Feedback Tap	 <p>The screenshot shows the 'Motion Axis Parameters' tab. The 'Feedback1 Velocity Filter Taps' parameter is highlighted with a blue circle and set to '16 # of Delay Taps'.</p> <table border="1" data-bbox="552 1228 1079 1522"> <thead> <tr> <th>Name</th> <th>Value</th> <th>Unit</th> </tr> </thead> <tbody> <tr><td>Feedback1 Type</td><td></td><td>Digital A/d</td></tr> <tr><td>Feedback1 Limit</td><td></td><td>Rev</td></tr> <tr><td>Feedback1 Velocity Filter Bandwidth</td><td>159.15632</td><td>Hz</td></tr> <tr><td><b>Feedback1 Velocity Filter Taps</b></td><td><b>16</b></td><td><b># of Delay Taps</b></td></tr> <tr><td>Home Direction</td><td></td><td>Forward bi-directional</td></tr> <tr><td>Home Limit Switch</td><td></td><td>Normally Open</td></tr> <tr><td>Home Mode</td><td></td><td>Active</td></tr> <tr><td>Home Offset</td><td>0.0</td><td>rev</td></tr> <tr><td>Home Position</td><td>0.0</td><td>rev</td></tr> <tr><td>Home Return Speed</td><td>0.0</td><td>rev/s</td></tr> <tr><td>Home Sequence</td><td></td><td>Immediate</td></tr> <tr><td>Home Speed</td><td>0.0</td><td>rev/s</td></tr> <tr><td>Induction Motor Flux Current</td><td>0.14</td><td>Amps (RMS)</td></tr> <tr><td>Induction Motor Rated Frequency</td><td>60.0</td><td>Hz</td></tr> <tr><td>Induction Motor Rated Slip Speed</td><td>200.0</td><td>RPM</td></tr> <tr><td>Induction Motor Rotor Leakage Reactance</td><td>149.8</td><td>Ohms</td></tr> <tr><td>Induction Motor Stator Leakage Reactance</td><td>149.8</td><td>Ohms</td></tr> <tr><td>Induction Motor Stator Resistance</td><td>164.8</td><td>Ohms</td></tr> <tr><td>Interpolated Actual Position Configuration</td><td></td><td>First Order</td></tr> <tr><td>Interpolated Command Position Configuration</td><td></td><td>Second Order</td></tr> </tbody> </table>	Name	Value	Unit	Feedback1 Type		Digital A/d	Feedback1 Limit		Rev	Feedback1 Velocity Filter Bandwidth	159.15632	Hz	<b>Feedback1 Velocity Filter Taps</b>	<b>16</b>	<b># of Delay Taps</b>	Home Direction		Forward bi-directional	Home Limit Switch		Normally Open	Home Mode		Active	Home Offset	0.0	rev	Home Position	0.0	rev	Home Return Speed	0.0	rev/s	Home Sequence		Immediate	Home Speed	0.0	rev/s	Induction Motor Flux Current	0.14	Amps (RMS)	Induction Motor Rated Frequency	60.0	Hz	Induction Motor Rated Slip Speed	200.0	RPM	Induction Motor Rotor Leakage Reactance	149.8	Ohms	Induction Motor Stator Leakage Reactance	149.8	Ohms	Induction Motor Stator Resistance	164.8	Ohms	Interpolated Actual Position Configuration		First Order	Interpolated Command Position Configuration		Second Order	16
Name	Value	Unit																																																															
Feedback1 Type		Digital A/d																																																															
Feedback1 Limit		Rev																																																															
Feedback1 Velocity Filter Bandwidth	159.15632	Hz																																																															
<b>Feedback1 Velocity Filter Taps</b>	<b>16</b>	<b># of Delay Taps</b>																																																															
Home Direction		Forward bi-directional																																																															
Home Limit Switch		Normally Open																																																															
Home Mode		Active																																																															
Home Offset	0.0	rev																																																															
Home Position	0.0	rev																																																															
Home Return Speed	0.0	rev/s																																																															
Home Sequence		Immediate																																																															
Home Speed	0.0	rev/s																																																															
Induction Motor Flux Current	0.14	Amps (RMS)																																																															
Induction Motor Rated Frequency	60.0	Hz																																																															
Induction Motor Rated Slip Speed	200.0	RPM																																																															
Induction Motor Rotor Leakage Reactance	149.8	Ohms																																																															
Induction Motor Stator Leakage Reactance	149.8	Ohms																																																															
Induction Motor Stator Resistance	164.8	Ohms																																																															
Interpolated Actual Position Configuration		First Order																																																															
Interpolated Command Position Configuration		Second Order																																																															

Out-of-Box Settings (Continued)

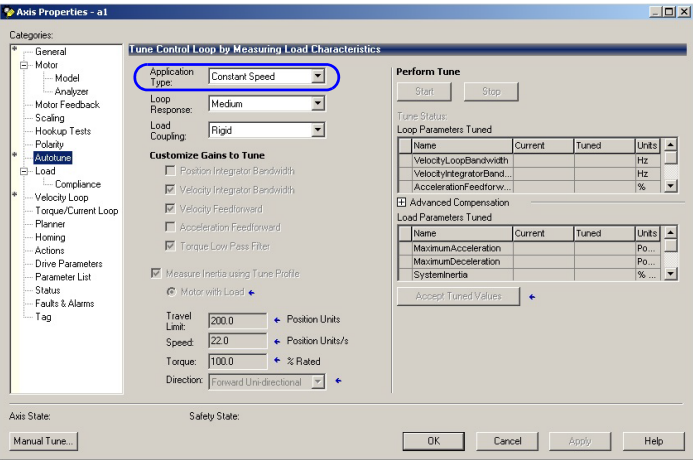
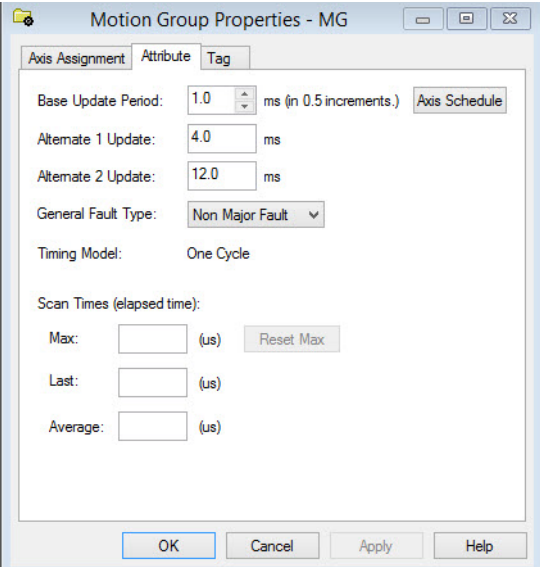
Setting in Logix Designer	Example	Recommended Configuration
Application Type setting in Velocity Loop		Constant Speed
Motion Group Base Update Rate		4 ms

## Setting the ACO/AVO Attribute

The attribute ACO/AVO (Analog Current Output/Analog Voltage Output) can be used to set the analog output of the PowerFlex 527 drive to either current (mA) or voltage (V).

Verify that the Analog Out jumper (J2) is also set to the same value. See [Analog Output on page 36](#) for instructions.

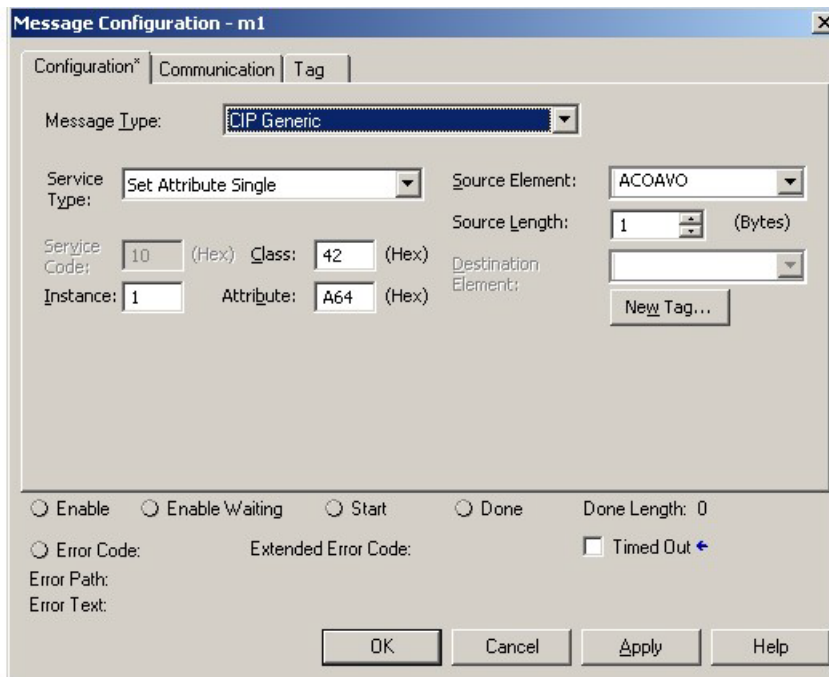

### ACO/AVO: MSG

Parameter	Value	Description
Service Code	0x10	Set Attribute Single
Class	0x42	Analog Output
Instance	1	-
Attribute	0xA64	Voltage/Current Mode
Data Type	SINT	Unsigned Short Integer

### ACO/AVO: Values

Value	Definition
0	Voltage (V)
1	Current (mA)



## Encoder Option Card Usage

### Installing the Encoder Option Card

To install the encoder option card:

1. Separate the power module and control module. See [Separating the Power and Control Module on page 26](#) for instructions.
2. Place the encoder option card on the back of the control module. Verify that the tabs on the encoder option card are aligned with the slots on the control module.

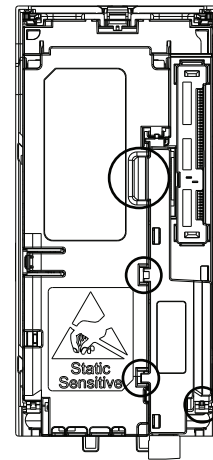
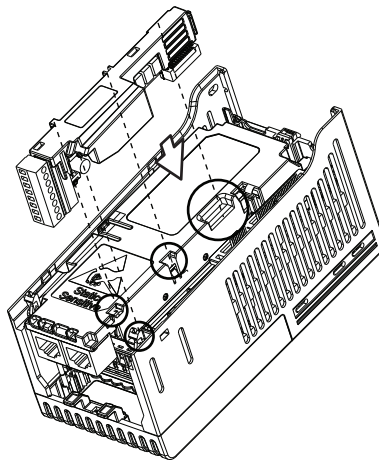

3. Press down firmly on the encoder option card until it snaps together with the control module.

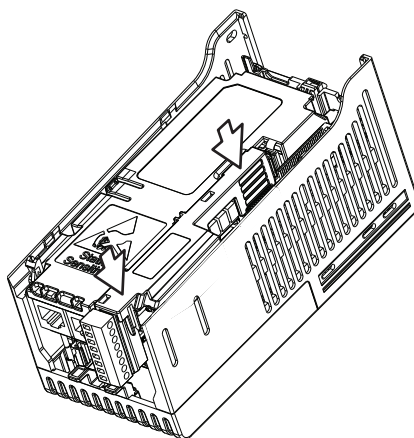

## Removing the Encoder Option Card

To remove the encoder option card:

1. Hold the top of the encoder option card firmly as shown below and pull out to remove.

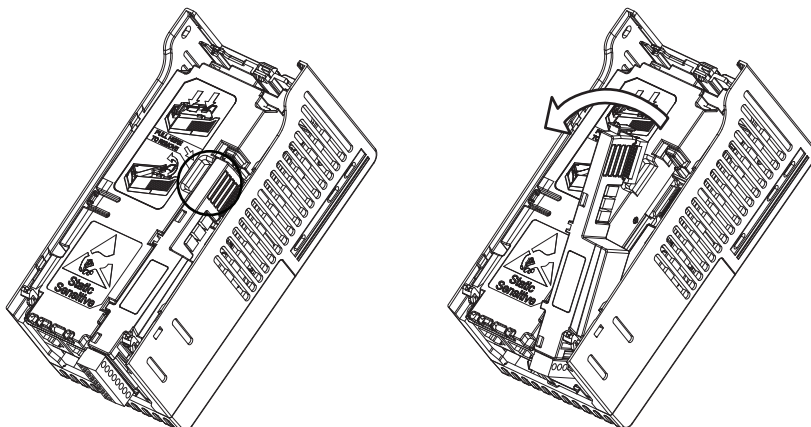

**IMPORTANT** Do not remove the encoder option card from the bottom as it may damage the card and the locking mechanism on the control module.

## Encoder Option Card Usage

PowerFlex 527 drives support an optional encoder card. The encoder supports up to 250 kHz dual channel at 5V, 12V, or 24V and requires the optional encoder board to be installed.

When the axis configuration is set to Position or Velocity loop, the Feedback Configuration is enabled.

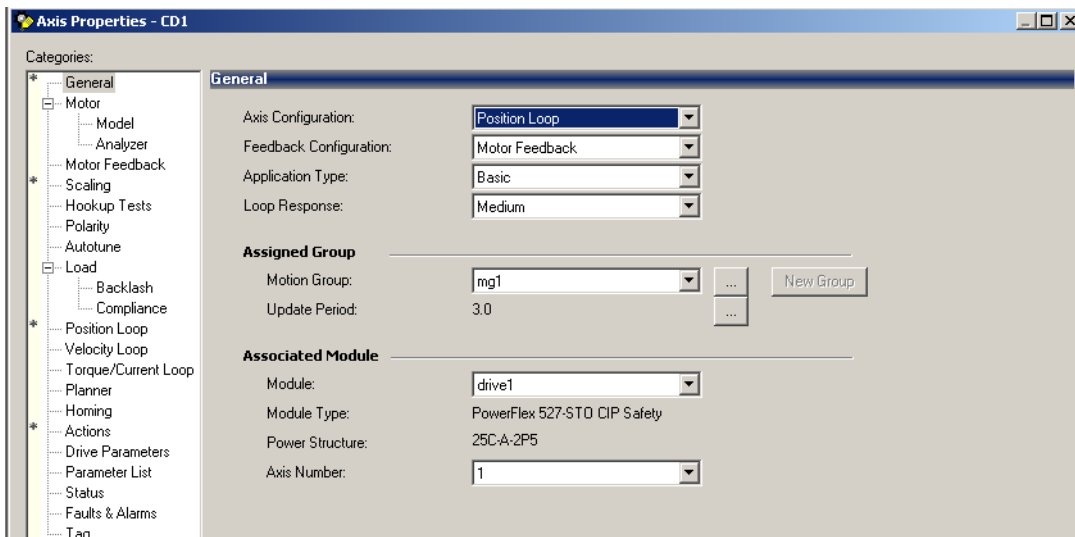

In the Motor Feedback configuration, enter the resolution of the encoder used.

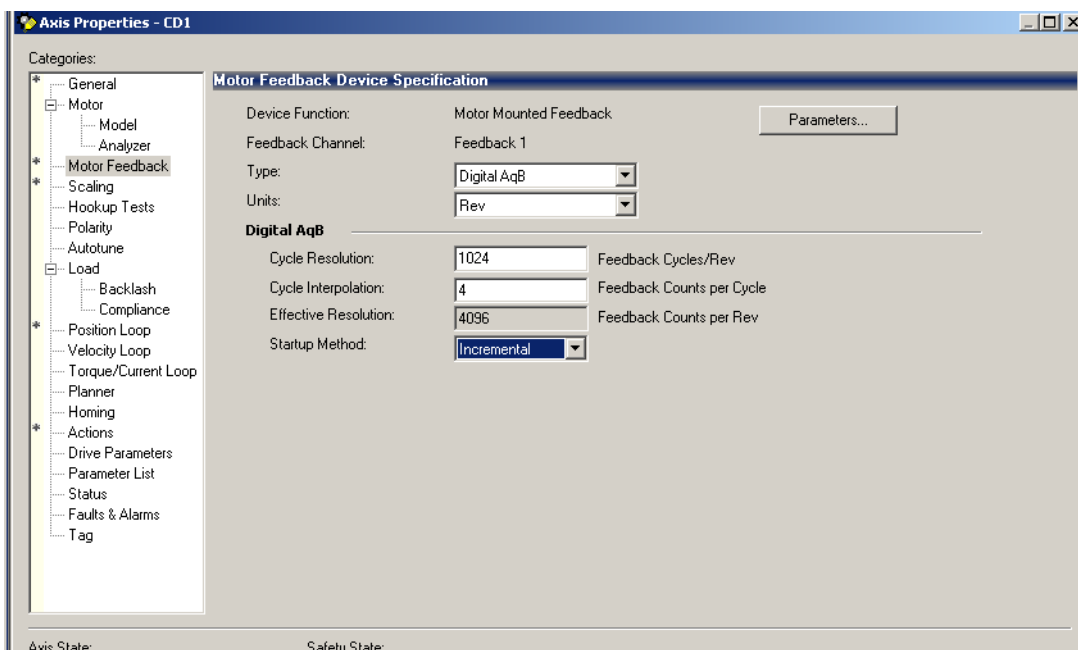

### Encoder Interface

The incremental encoder option card can source 5V or 12V power and accept 5V, 12V, or 24V single ended or differential inputs. See [Appendix B](#) for ordering information.

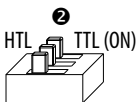
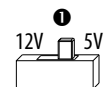
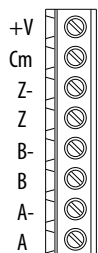

No.	Signal	Description
+V	5...12V Power <sup>(1)(2)</sup>	Internal power source 250 mA (isolated).
Cm	Power Return	
Z-	Marker Z (NOT)	Marker pulse
Z	Marker Z	
B-	Encoder B (NOT)	Quadrature B input.
B	Encoder B	
A-	Encoder A (NOT)	Quadrature A input.
A	Encoder A	
1	Output	DIP switch selects 12V or 5V power that is supplied at terminals "+V" and "Cm" for the encoder.
2	HTL/TTL DIP switches	Set the position of the DIP switches based on the type of encoder signal used. You must set all switches to the same position.

(1) When using 12V Encoder power, 24V I/O power, maximum output current at I/O Terminal 11 is 50 mA.  
 (2) If Encoder requires 24V power, it must be supplied by an external power source.

**IMPORTANT** A quadrature encoder provides rotor speed and direction. Therefore, the encoder must be wired such that the forward direction matches the motor forward direction. If the drive is reading encoder speed but the position regulator or other encoder function is not working properly, remove power to the drive and swap the A and A (NOT) encoder channels or swap any two motor leads.

Encoder Wiring Examples

I/O	Connection Example	I/O	Connection Example
<b>Encoder Power - Internal Drive Power</b>  Internal (drive) 12V DC, 250 mA		<b>Encoder Power - External Power Source</b>	
<b>Encoder Signal - Single-Ended, Dual Channel</b>		<b>Encoder Signal - Differential, Dual Channel</b>	

HTL/TTL DIP Switches

This feature is only available on 25-ENC-2/B encoders. Set the three switches to HTL (default) or TTL (On) based on the type of encoder signal you are using in your application. You must set all switches to the same position.

Compatible Encoder Output Voltage

Switch Position	Low Level (UL)	High Level (UH)
TTL	<1.5V	>2.5V
HTL	<3.5V	>5V

Wiring Notes

The encoder option card can supply 5V or 12V power (250 mA maximum) for an encoder. Verify that the DIP switch is set properly for the encoder. In general, 12V provides higher noise immunity.

The encoder can handle 5V, 12V, or 24V inputs. The inputs automatically adjust to the voltage applied and no additional drive adjustment is necessary.

**IMPORTANT** A quadrature encoder provides rotor speed and direction. Therefore, the encoder must be wired such that the forward direction matches the motor forward direction. If the drive is reading encoder speed but the position regulator or other encoder function is not working properly, remove power to the drive and swap the A and A (NOT) encoder channels or swap any two motor leads.

**A**

- accessing**
  - control terminals 29
  - power terminals 29
- auxiliary contact**
  - drive 32

**B**

- basic operation**
  - drive 45

**C**

- circuit breakers**
  - inputs 20
  - ratings 20
- control terminals**
  - accessing 29

**D**

- derating**
  - temperature 15
- dimensions**
  - mounting 14, 144
- disconnect**
  - output 32
- drive**
  - auxiliary contact 32
  - basic operation 45
  - mount 13
  - programming 51
- drive damage**
  - preventing 17
  - ungrounded distribution systems 17

**E**

- encoder**
  - wiring 166
- environment**
  - storage 16

**F**

- fault monitoring**
  - ground 18
- fuses**
  - rating 20

**G**

- ground**
  - fault monitoring 18
  - motor 19
  - RFI filter 19
  - safety 19
  - shielding 19

**I**

- inputs**
  - circuit breakers 20
  - power 18

**M**

- motor**
  - ground 19
  - start 32
  - stop 32
- mount**
  - drive 13
- mounting**
  - dimensions 14, 144

**N**

- noise immunity**
  - wiring 34

**O**

- output**
  - disconnect 32

**P**

- power**
  - inputs 18
- power and control module**
  - separating 26
- power terminals**
  - accessing 29
- preventing**
  - drive damage 17
- programming**
  - drive 51
  - tools 51

**R**

- rating**
  - fuses 20
- ratings**
  - circuit breakers 20
- recommended**
  - wiring 33, 34
- reflected**
  - wave protection 32
- RFI filter**
  - ground 19

**S**

- safety**
  - ground 19
- separating**
  - power and control module 26

**shielded**

wiring 31

**shielding**

ground 19

**start**

motor 32

**stop**

motor 32

**storage**

environment 16

**T**

**temperature**

derating 15

wiring 30

**tools**

programming 51

**U**

**unshielded**

wiring 31

**V**

**voltage reflections**

wiring 32

**W**

**wave protection**

reflected 32

**wiring**

encoder 166

noise immunity 34

recommended 33, 34

shielded 31

temperature 30

unshielded 31

voltage reflections 32



# Rockwell Automation Support

Use these resources to access support information.

<b>Technical Support Center</b>	Find help with how-to videos, FAQs, chat, user forums, Knowledgebase, and product notification updates.	<a href="http://rok.auto/support">rok.auto/support</a>
<b>Local Technical Support Phone Numbers</b>	Locate the telephone number for your country.	<a href="http://rok.auto/phonesupport">rok.auto/phonesupport</a>
<b>Technical Documentation Center</b>	Quickly access and download technical specifications, installation instructions, and user manuals.	<a href="http://rok.auto/techdocs">rok.auto/techdocs</a>
<b>Literature Library</b>	Find installation instructions, manuals, brochures, and technical data publications.	<a href="http://rok.auto/literature">rok.auto/literature</a>
<b>Product Compatibility and Download Center (PCDC)</b>	Download firmware, associated files (such as AOP, EDS, and DTM), and access product release notes.	<a href="http://rok.auto/pcdc">rok.auto/pcdc</a>

## Documentation Feedback

Your comments help us serve your documentation needs better. If you have any suggestions on how to improve our content, complete the form at [rok.auto/docfeedback](http://rok.auto/docfeedback).

## Waste Electrical and Electronic Equipment (WEEE)



At the end of life, this equipment should be collected separately from any unsorted municipal waste.





Rockwell Automation maintains current product environmental compliance information on its website at [rok.auto/pec](http://rok.auto/pec).

Allen-Bradley, CompactLogix, ControlLogix, expanding human possibility, FactoryTalk, GuardLogix, Logix 5000, PowerFlex, Rockwell Automation, RSLinx, RSLogix 5000, Studio 5000, Studio 5000 Automation Engineering & Design Environment, Studio 5000 Logix Designer, and TechConnect are trademarks of Rockwell Automation, Inc.

CIP, CIP Motion, CIP Safety, CIP Sync, and EtherNet/IP are trademarks of ODVA, Inc.

Trademarks not belonging to Rockwell Automation are property of their respective companies.

Rockwell Otomasyon Ticaret A.Ş. Kar Plaza İş Merkezi E Blok Kat:6 34752, İçerenköy, İstanbul, Tel: +90 (216) 5698400 EEE Yönetmeliğine Uygundur

Connect with us.    

**rockwellautomation.com** ————— expanding **human possibility**<sup>®</sup>

AMERICAS: Rockwell Automation, 1201 South Second Street, Milwaukee, WI 53204-2496 USA, Tel: (1) 414.382.2000, Fax: (1) 414.382.4444

EUROPE/MIDDLE EAST/AFRICA: Rockwell Automation NV, Pegasus Park, De Kleetlaan 12a, 1831 Diegem, Belgium, Tel: (32) 2 663 0600, Fax: (32) 2 663 0640

ASIA PACIFIC: Rockwell Automation, Level 14, Core F, Cyberport 3, 100 Cyberport Road, Hong Kong, Tel: (852) 2887 4788, Fax: (852) 2508 1846

UNITED KINGDOM: Rockwell Automation Ltd. Pitfield, Kiln Farm Milton Keynes, MK11 3DR, United Kingdom, Tel: (44)(1908) 838-800, Fax: (44)(1908) 261-917

Publication 520-UM002D-EN-E - January 2023

Supersedes Publication 520-UM002C-EN-E - July 2019

Copyright © 2023 Rockwell Automation, Inc. All rights reserved.