

## IEC Load Switches

# Bulletin 194E

### 25 Amps to 100 Amps

---



### Description

Bulletin 194E load switches are designed for use as local motor isolation and IEC disconnect switch applications outside North America. Available with 3- and 6-pole versions with add-on additional poles, grounding and neutral terminals and auxiliary contacts, Bulletin 194Es share the same operating handles as the Bulletin 194L Control and Load Switches.

Bulletin 194E switches are offered in two mounting styles, Front/Door and Base/DIN configurations for a variety of installations. Switch body styles for Bulletin 194E base-mounted switches include standard interlock shaft; Bulletin 194E front-mounted switches include standard shaft.

Two-position OFF-ON switch is used to connect or disconnect a variety of inductive loads, including solenoids, actuators, valves, magnetic starters, relays, and motors.

Actuators featuring marked legend plates are available in Selector-Knob, Disk-Style, Rectangular-Style and Key-Operated versions. Selector-Knob versions are available in three sizes. Most actuators are available in colours of Gray/Black or Red/Yellow and have padlockable versions.

### Features

- At-Motor Disconnect Switch
- 25, 32, 40, 63, 80, 100 A Inductive Load-Rated Switches
- IP65/Type 1/3/3R/12 Operating Handles
- IP2LX Finger-Safe Terminals
- 3- and 6-Pole Versions;  
Add-on Accessory Poles to Make 4-, 5-, 7- and 8-Pole Units
- Front/Door or DIN/Base Mounting Configurations
- Change over Switches
- OFF-ON Configurations
- 3- and 6-Pole Enclosed Switches
- Optional Thermoplastic Enclosures
- Positive-Guided Actuation
- Suitable as Motor Disconnect

### Conformity to Standards

- IEC 207
- IEC 947-1
- IEC 947-3 low-voltage switch gear and control gear part 3: switches, disconnectors, switch-disconnectors and fuse-combination units. CE marked for all applicable directives.
- UL 508: Industrial Control Equipment. cUL, 1999 edition
- CSA: C22.2 No. 14: Industrial Control Equipment

### Approvals

- UL listed (file number E54612 NLRV)
- CSA certified (LR 13002)
- Meets IEC, VDE and BS standard requirements
- IEC/CE marked for all applicable directives (per EN 60947-3)
- R.I.Na.—Italian Naval Registry

### Your order must include:

- Catalogue Number of switch body
- Catalogue Number of actuator
- If required, Catalogue Number of accessories

**Product Selection**

**OFF-ON Base-Mounted 3-Pole Switch (includes operating shaft) (Actuators listed on pages 10-4 and 10-5)**

Switch Body (Includes Shaft)	Function Switching Angle	Contact Target Configuration X = Contact Closed O = Contact Open		Maximum Load Rating (A)	AC23A Rated Power [kW] at 690V AC 50 Hz	HP @ 480V AC 60 Hz 3 ∅	Catalogue Number	
		No. of Circuits	Handle Position					
			OFF/0 					ON/1 
		1 2 3	O O O	X X X	25	11	10	194E-A25-1753
					32	15	15	194E-A32-1753
					40	18.5	20	194E-A40-1753
					63	22	25	194E-A63-1753
					80	37	50	194E-A80-1753
					100	45	50	194E-A100-1753

**OFF-ON Front-Mounted 3-Pole Switch (includes operating shaft) (Actuators listed on pages 10-4 and 10-5)**

		1 2 3	O O O	X X X	25	11	10	194E-E25-1753
					32	15	15	194E-E32-1753
					40	18.5	20	194E-E40-1753
					63	22	25	194E-E63-1753
					80	37	50	194E-E80-1753
					100	45	50	194E-E100-1753

**OFF-ON Base-Mounted 6-Pole Switch (includes operating shaft) (Actuators listed on pages 10-4 and 10-5)**

		1 2 3 4 5 6	O O O O O O	X X X X X X	25	11	10	194E-A25-1756
					32	15	15	194E-A32-1756
					40	18.5	20	194E-A40-1756
					63	22	25	194E-A63-1756
					80	37	50	194E-A80-1756
					100	45	50	194E-A100-1756

**OFF-ON Front-Mounted 6-Pole Switch (includes operating shaft) (Actuators listed on pages 10-4 and 10-5)**

		1 2 3 4 5 6	O O O O O O	X X X X X X	25	11	10	194E-E25-1756
					32	15	15	194E-E32-1756
					40	18.5	20	194E-E40-1756
					63	22	25	194E-E63-1756
					80	37	50	194E-E80-1756
					100	45	50	194E-E100-1756

**IEC Load Switches**  
**Bulletin 194E**  
**25 Amps to 100 Amps**

**Product Selection**

**OFF-ON Base/Front-Mounted 3- and 6-Pole Switches (continued) (Switch Body listed on page 10-3)**

Actuators with Screw Fixing (Includes Legend Plate and Control Knob)	Rating	Colour	Legend Plate Size	Use with Catalogue Number	Legend Marking	Catalogue Number		
 Type A	IP65	Black/Gray	48 mm x 48 mm (1-57/64in x 1-57/64in)	194E-25...63A	0-1	194L-HE4A-175		
					OFF-ON	194L-HE4A-175I		
					64 mm x 64 mm (2-33/64in x 2-33/64in)	194E-25...100A	0-1	194L-HE6A-175
					OFF-ON		194L-HE6A-175I	
					88 mm x 88 mm (3-15/32in x 3-15/32in)	194E-40...100A	0-1	194L-HE8A-175
					OFF-ON		194L-HE8A-175I	
 Type I	IP65	Red/Yellow	48 mm x 48 mm (1-57/64in x 1-57/64in)	194E-25...63A	0-1	194L-HE4I-175		
					OFF-ON	194L-HE4I-175I		
					64 mm x 64 mm (2-33/64in x 2-33/64in)	194E-25...100A	0-1	194L-HE6I-175
					OFF-ON		194L-HE6I-175I	
					88 mm x 88 mm (3-15/32in x 3-15/32in)	194E-40...100A	0-1	194L-HE8I-175
					OFF-ON		194L-HE8I-175I	
 Type E with Locking for One Padlock (Padlock Not Included)	IP65	Black/Gray	48 mm x 48 mm (1-57/64in x 1-57/64in)	194E-25...63A	0-1	194L-HE4E-175		
					OFF-ON	194L-HE4E-175I		
					64 mm x 64 mm (2-33/64in x 2-33/64in)	194E-25...100A	0-1	194L-HE6E-175
					OFF-ON		194L-HE6E-175I	
 Type L with Locking for One Padlock (Padlock Not Included)	IP65	Red/Yellow	48 mm x 48 mm (1-57/64in x 1-57/64in)	194E-25...63A	0-1	194L-HE4L-175		
					OFF-ON	194L-HE4L-175I		
					64 mm x 64 mm (2-33/64in x 2-33/64in)	194E-25...100A	0-1	194L-HE6L-175
					OFF-ON		194L-HE6L-175I	
 Type G	IP65 Type 3/3R/12	Black/Gray	67 mm x 67 mm (2-41/64in x 2-41/64in)	194E-25...100A	0-1 OFF-ON	194L-HE6G-175		
						0-1 OFF-ON	194L-HE8G-175	
					88 mm x 88 mm (3-15/32in x 3-15/32in)	194E-40...100A	0-1 OFF-ON	194L-HE8G-175
 Type N	IP65 Type 3/3R/12	Red/Yellow	67 mm x 67 mm (2-41/64in x 2-41/64in)	194E-25...100A	0-1 OFF-ON	194L-HE6N-175		
						0-1 OFF-ON	194L-HE8N-175	
					90 mm x 90 mm (3-35/64in x 3-35/64in)	194E-40...100A	0-1 OFF-ON	194L-HE8N-175
 Type S	IP65	Black/Gray	48 mm x 62 mm (1-57/64in x 2-7/16in)	194E-25...63A	0-1	194L-HE4S-175		
					OFF-ON	194L-HE4S-175I		
					64 mm x 78 mm (2-33/64in x 3-5/64in)	194E-25...100A	0-1	194L-HE6S-175
					OFF-ON		194L-HE6S-175I	

Accessories — Page 10-11  
 Specifications — Page 10-17  
 Approximate Dimensions — Page 10-19

**Product Selection**

**OFF-ON Front-Mounted 3- and 6-Pole Switches (continued) (Switch Body listed on page 10-3)**

Actuators with Central Fixing (Includes Legend Plate & Control Knob)❶	Rating	Colour	Legend Plate Size	Use with Catalogue Number	Legend Marking	Catalogue Number
 Type A	IP65	Black/Gray	48 mm x 48 mm (1-57/64in x 1-57/64in)	194E-E25...63A	0-1	194L-HC4A-175
					OFF-ON	194L-HC4A-175I
 Type I	IP65	Red/Yellow	48 mm x 48 mm (1-57/64in x 1-57/64in)	194E-E25...63A	0-1	194L-HC4I-175
					OFF-ON	194L-HC4I-175I
 Type E with Locking (Padlock not Included)	IP65	Black/Gray	48 mm x 48 mm (1-57/64in x 1-57/64in)	194E-E25...63A	0-1	194L-HC4E-175
					OFF-ON	194L-HC4E-175I
 Type L with Locking (Padlock not Included)	IP65	Red/Yellow	48 mm x 48 mm (1-57/64in x 1-57/64in)	194E-E25...63A	0-1	194L-HC4L-175
					OFF-ON	194L-HC4L-175I

❶ Use central-mounted handles with Catalogue Number 194E...switches.

Accessories — Page 10-11  
 Specifications — Page 10-17  
 Approximate Dimensions — Page 10-19

**IEC Load Switches**  
**Bulletin 194E**  
**25 Amps to 100 Amps**



**Product Selection**

**OFF-ON Front-Mounted 3- and 6-Pole Switches (continued) (Switch Body listed on page 10-3)**

194L/194E Disk Actuators with Central Fixing (Type G, N) — Size 6

	Rating	Colour	Legend Plate Size	Use with Catalogue Number	Legend Marking	Catalogue Number
 Type G, N	IP65 Type 3/3R/12	Black/ Gray	67 mm x 67 mm (2-33/64in x 2-33/64in)	194L-E25...100	0-1 OFF-ON	194L-HC6G-175
		Red/ Yellow			0-1 OFF-ON	194L-HC6N-175

194L/194E Central Fixing Actuators (Type B, D)

	Description	Pkg. Qty.	Catalogue Number
 Type B	Central-Mounting Actuators (IP65) Handle Style: Knob Lever with Latch (Use with Catalogue Number <b>194E-E25-100-1753</b> )	1	194L-HCB-001
 Type D	Key Removal Position (Includes Latch) — Central Fixing Use with Catalogue Number <b>194L-E25-100-1753</b>	1	194L-HCDC-001
	Key Removal Position (Includes Latch) — Central Fixing Use with Catalogue Number <b>194L-E25-100-1753</b>		194L-HCDD-001
	Key Removal Position (Includes Latch) — Central Fixing Use with Catalogue Number <b>194L-E25-100-1753</b>		194L-HCDG-001
	Key Removal Position (Includes Latch) — Central Fixing Use with Catalogue Number <b>194L-E25-100-1753</b>		194L-HCDH-001

3-Position Front-Mounted Change over Switch (Includes Shaft)

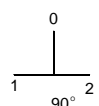
Switch Body (Includes Shaft)	Function Switching Angle	Contact Target Configuration			Maximum Load Rating (A)	AC23A Rated Power [kW] at 690V AC 50 Hz.	HP @ 480V AC 60 Hz, 3 ∅	Catalogue Number	
		Handle Position							
		No. of Circuits	1	0					2
		1	X	O	O	25	11	10	194E-A25-3753
		2	X	O	O	32	15	15	194E-A32-3753
		3	X	O	O	40	18.5	20	194E-A40-3753
		4	O	O	X	63	22	25	194E-A63-3753
		5	O	O	X	80	37	50	194E-A80-3753
		6	O	O	X	100	45	50	194E-A100-3753

Accessories — Page 10-11

Specifications — Page 10-17

Approximate Dimensions — Page 10-19

**Product Selection**

**OFF-ON Front-Mounted 3- and 6-Pole Switches (continued) (Switch Body listed on page 10-3)**

*3-Position Change over Switch, Door Mount (includes operating shaft)*

Switch Body (Includes Shaft)	Function Switching Angle	Contact Target Configuration X=Contact Closed O=Contact Open			Maximum Load Rating (A)	AC23A Rated Power [kW] at 690V AC 50 Hz.	HP @ 480V AC 60 Hz, 3 Ø	Catalogue Number	
		No. of Cir- cuits	Handle Position						
			1 	0 					2 
		1	X	O	O	25	11	10	194E-E25-3753
		2	X	O	O	32	15	15	194E-E32-3753
		3	X	O	O	40	18.5	20	194E-E40-3753
		4	O	O	X	63	22	25	194E-E63-3753
		5	O	O	X	80	37	50	194E-E80-3753
		6	O	O	X	100	45	50	194E-E100-3753

*Actuators for Change over Switches*

Actuators with Screw Fixing (Includes Legend Plate & Control Knob)	Rating	Colour	Legend Plate Size	Use with Catalogue Number	Legend Marking	Catalogue Number
	IP65	Black/Gray	48 mm x 48 mm (1-57/64in x 1-57/64in)	194E-25...63-3753	I - O - 2	194L-HE4A-375
			64 mm x 64 mm (2-33/64in x 2-33/64in)	194E-25...100-3753	I - O - 2	194L-HE6A-375

*Base-Mounting Distribution Switches*

Function Switching Angle	No. of Cir- cuits	Contact Target		Colour	Marking	Lockable (one padlock)	$I_{max}$ [A]	AC23A Rated Power [kW] at 690V AC	HP @ 480V AC 60 Hz, 3 Ø	Catalogue Number	
		OFF/0	ON/ 1								
		1	O	X	Red/ Yellow	O-1	No	25	11	10	194E-A25-1753-R
		2	O	X	Black/Gray	O-1	Yes				194E-A25-1753-Q
		3	O	X	Red/ Yellow	O-1	No	32	15	15	194E-A32-1753-R
					Black/Gray	O-1	Yes				194E-A32-1753-Q

IEC Load Switches  
**Bulletin 194E**  
 25 Amps to 100 Amps

**Product Selection**

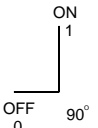
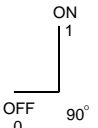

Enclosed Switch with Catalogue Number 194L-HE6N-175 Operating Handle and Thermoplastic Enclosure

 Uses Base-Mounted Switches	No. of Poles	Function Switching Angle	Maximum Load Rating (A)	Colour	Catalogue Number
	3	90°		25	Red/Yellow
32				194E-Y32-1753-6N	
40				194E-Y40-1753-6N	
63				194E-Y63-1753-6N	
80				194E-Y80-1753-6N	
100				194E-Y100-1753-6N	
6	90°		25	Red/Yellow	194E-Y25-1756-6N
			32		194E-Y32-1756-6N
			40		194E-Y40-1756-6N
			63		194E-Y63-1756-6N

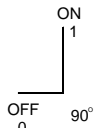
OFF-ON Base-Mounted 3-Pole Switch with Catalogue Number 194L-HE6N-175 Red/Yellow Actuator Kits

 Type N	Function Switching Angle	Maximum Load Rating (A)	AC23A Rated Power [kW] at 690V AC	HP @ 480V AC 60 Hz, 3 ∅	Catalogue Number
	90°		25	7.5	10
32			11	15	194E-A32-1753-6N
40			15	20	194E-A40-1753-6N
63			18.5	25	194E-A63-1753-6N
80			30	50	194E-A80-1753-6N
100			37	50	194E-A100-1753-6N

OFF-ON Front-Mounted 3-Pole Switch with Catalogue Number 194L-HE6N-175 Red/Yellow Actuator Kits

 Type N	Function Switching Angle	Maximum Load Rating (A)	AC23A Rated Power [kW] at 690V AC	HP @ 480V AC 60 Hz, 3 ∅	Catalogue Number
	90°		25	7.5	10
32			11	15	194E-E32-1753-6N
40			15	20	194E-E40-1753-6N
63			18.5	25	194E-E63-1753-6N
80			30	50	194E-E80-1753-6N
100			37	50	194E-E100-1753-6N

Accessories — Page 10-11  
 Specifications — Page 10-17  
 Approximate Dimensions — Page 10-19

**Product Selection (continued)**

**Enclosed Disconnect Load Switches — 3-Pole Base-Mounted**

*Stainless Steel Enclosures IP66/Type 4/4X*

	Maximum Load Rating (A)	Ref. Dim. Page	Handle Colour	Catalogue Number ❶
	25	A1	Black	194E-CA20
			Red/Yellow	194E-CA20E
	32	A1	Black	194E-CA32
			Red/Yellow	194E-CA32E
	40	A1	Black	194E-CA40
			Red/Yellow	194E-CA40E
	63	A1	Black	194E-CA63
			Red/Yellow	194E-CA63E
	80	B1	Black	194E-CA80
			Red/Yellow	194E-CA80E
	100	B1	Black	194E-CA00
			Red/Yellow	194E-CA00E

*Painted Steel Enclosures IP66/Type 3/4/12 — 3-Pole Base-Mounted*

	Maximum Load Rating (A)	Ref. Dim. Page	Handle Colour	Catalogue Number ❶
	25	A1	Black	194E-FA20
			Red/Yellow	194E-FA20E
	32	A1	Black	194E-FA32
			Red/Yellow	194E-FA32E
	40	A1	Black	194E-FA40
			Red/Yellow	194E-FA40E
	63	A1	Black	194E-FA63
			Red/Yellow	194E-FA63E
	80	B1	Black	194E-FA80
			Red/Yellow	194E-FA80E
	100	B1	Black	194E-FA00
			Red/Yellow	194E-FA00E

*Non-Metallic Enclosures IP66/Type 3/4/4X — 3-Pole Base-Mounted*

	Maximum Load Rating (A)	Ref. Dim. Page	Handle Colour	Catalogue Number ❶
	25	C1	Black	194E-KA20
			Red/Yellow	194E-KA20E
	32	C1	Black	194E-KA32
			Red/Yellow	194E-KA32E
	40	C1	Black	194E-KA40
			Red/Yellow	194E-KA40E
	63	C1	Black	194E-KA63
			Red/Yellow	194E-KA63E
	80	D1	Black	194E-KA80
			Red/Yellow	194E-KA80E
	100	D1	Black	194E-KA00
			Red/Yellow	194E-KA00E

❶ Modifications: Up to two suffix codes may be added to an enclosed disconnect load switch. Example: Catalogue Number 194E-CA20-NP is a disconnect load switch with a power pole in a stainless steel enclosure (see page 10-14).

Accessories — Page 10-11

Specifications — Page 10-17

Approximate Dimensions — Page 10-19





IEC Load Switches  
**Bulletin 194E**  
 25 Amps to 100 Amps

**Product Selection**

**Enclosed Disconnect Load Switches — 3-Pole Base-Mounted (continued)**

*Metallic Enclosures IP54/Type 1 — 3-Pole*

	Maximum Load Rating (A)	Ref. Dim. Page	Handle Colour	Catalogue Number <sup>❶</sup>
	25	A1	Black	194E-AA20
Red/Yellow			194E-AA20E	
32	A1	Black	194E-AA32	
		Red/Yellow	194E-AA32E	
40	A1	Black	194E-AA40	
		Red/Yellow	194E-AA40E	
63	A1	Black	194E-AA63	
		Red/Yellow	194E-AA63E	
80	B1	Black	194E-AA80	
		Red/Yellow	194E-AA80E	
100	B1	Black	194E-AA00	
		Red/Yellow	194E-AA00E	

	ABS Thermoplastic Enclosure — IP65, For High-Impact Applications	No. of Poles	Use with Catalogue Number	Catalogue Number
			3...4	194E-25/32
3...4			194E-40/63	194L-G3663
3...4			194E-80/100	194E-G3665
6			194E-25/32	194E-G3663
6			194E-40/63	194E-G3665

	Noryl Thermoplastic Enclosures — IP65, For Corrosion-Prone Applications	No. of Poles	Switch Usage for Catalogue Number	Catalogue Number
			3...4	194E-25/32
3...4			194E-40/63	194L-G3664
3...4			194E-80/100	194E-G3666
6			194E-25/32	194E-G3664
6			194E-40/63	194E-G3666

Description	Use with Enclosures Catalogue Number	Catalogue Number
Additional Earth/Ground and Neutral Terminals — For Thermoplastic Enclosure	194L-G3663, G3664, G3665, G3666 (5 per package)	194L-G3673
	194L-G3572 and G3676 (5 per package)	194L-G3653

❶ Modifications: Up to two suffix codes may be added to an enclosed disconnect load switch. Example: Catalogue Number 194E-CA20-NP is a disconnect load switch with a power pole in a stainless steel enclosure (see page 10-14).

Accessories — Page 10-11  
 Specifications — Page 10-17  
 Approximate Dimensions — Page 10-19

**Accessories**



Auxiliary Contacts	Type	Use with Catalogue Number	Catalogue Number ❶
	1 N.O. + 1 N.C.	194E-A25...100	194E-A-P11
		194E-E25...100	194E-E-P11
	1 N.O. + 1 N.C.L.B.	194E-A25...100	194E-A-PL11
		194E-E25...100	194E-E-PL11
	2 N.O. + 2 N.C.	194E-A25...100	194E-A-P22
		194E-E25...100	194E-E-P22
	1 N.O. E.B.	194E-A25...100	194E-A-PD10
		194E-E25...100	194E-E-PD10
Additional Pole	Use with Catalogue Number		Catalogue Number ❶
	194E-A25		194E-A25-NP
	194E-A32		194E-A32-NP
	194E-A40		194E-A40-NP
	194E-A63		194E-A63-NP
	194E-A80		194E-A80-NP
	194E-A100		194E-A100-NP
	194E-E25		194E-E25-NP
	194E-E32		194E-E32-NP
	194E-E40		194E-E40-NP
	194E-E63		194E-E63-NP
	194E-E80		194E-E80-NP
	194E-E100		194E-E100-NP
Earthing/Grounding Terminal	Use with Catalogue Number		Catalogue Number ❶
	194E-A25/32		194E-A32-PE
	194E-A40/63		194E-A63-PE
	194E-A80/100		194E-A100-PE
	194E-E25/32		194E-E32-PE
	194E-E40/63		194E-E63-PE
	194E-E80/100		194E-E100-PE
Neutral Terminal	Use with Catalogue Number		Catalogue Number ❶
	194E-A25/32		194E-A32-TN
	194E-A40/63		194E-A63-TN
	194E-A80/100		194E-A100-TN
	194E-E25/32		194E-E32-TN
	194E-E40/63		194E-E63-TN
	194E-E80/100		194E-E100-TN

❶ A maximum of two side-mount accessories may be added to a 194E switch.

IEC Load Switches  
**Bulletin 194E**  
 25 Amps to 100 Amps

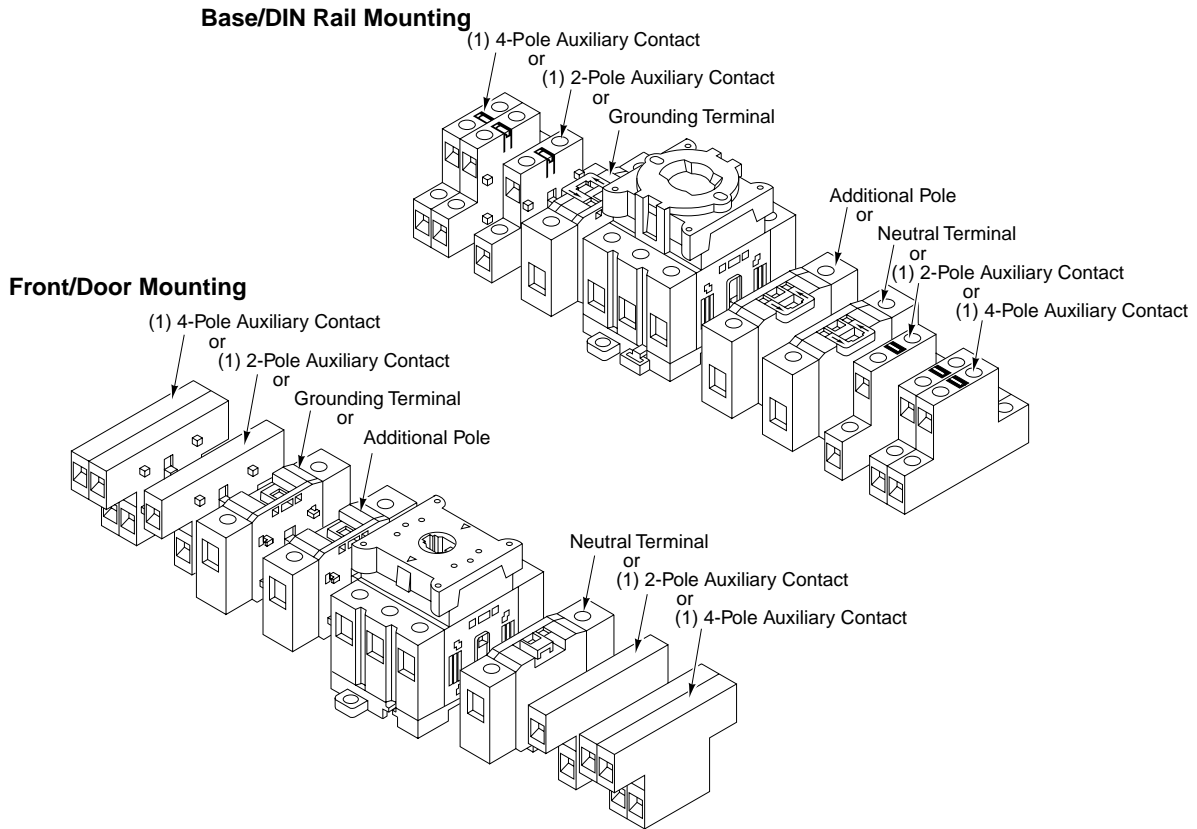

Accessories



Terminal Covers	Number of Poles	Use with Catalogue Number	Catalogue Number
	3	194E-25/32	194E-25-C3
		194E-40/63	194E-40-C3
		194E-80/100	194E-80-C3
	4	194E-25/32	194E-25-C4
		194E-40/63	194E-40-C4
		194E-80/100	194E-80-C4
6-Pole Mechanical Coupling		Use with Catalogue Number	Catalogue Number
		194E-25/32	194E-G3660
		194E-40/63	194E-G3661
		194E-80/100	194E-G3662

**Note:** User must order (2) Bulletin 194E 3-Pole Switches separately.

**Accessories (continued)**

Blank Legend Plate with Bezel	Package Quantity	Catalogue Number
	10	194L-A4-000
		194L-A6-000
		194L-A8-000
		194L-I4-000
		194L-I6-000
		194L-I8-000
0-1 Marked Legend Plates with Bezel	Package Quantity	Catalogue Number
	10	194L-A4-175
		194L-A6-175
		194L-A8-175
		194L-I4-175
		194L-I6-175
		194L-I8-175
OFF-ON Marked Legend Plate w/Bezel	Package Quantity	Catalogue Number
	10	194L-A4-175I
		194L-A6-175I
		194L-A8-175I
		194L-I4-175I
		194L-I6-175I
		194L-I8-175I

**Additional Legend Plates/Frames**

	Colour	Legend Size	Use with	Legend Marking	Catalogue Number	
	Gray/Black	19.2 mm x 49 mm 3/4 in. x 1-59/64 in.	Size 6 Type G and N Style Actuators 194L-HE6G/N	(Blank)	194L-G3515	
				MAIN SWITCH	194L-G3515A	
				HAUPTSCHALTER	194L-G3515B	
				INTERR. PRINCIPALE	194L-G3515C	
				INTERR. PRINCIPAUX	194L-G3515D	
				INTERR. PRINCIPAL	194L-G3515E	
				HUVUDBRYTARE	194L-G3515F	
				WAHLSCHALTER	194L-G3515G	
	Red/Yellow				EMERGENCY OFF	194L-G3515H
					(Blank)	194L-G3667
	Gray/Black	18 mm x 84 mm 11/16 in. x 3-5/16 in.	Size 8 Type G and N Style Actuators 194L-HE8G/N		MAIN SWITCH	194L-G3667A
					HAUPTSCHALTER	194L-G3667B
					INTERR. PRINCIPALE	194L-G3667C
					INTERR. PRINCIPAUX	194L-G3667D
INTERR. PRINCIPAL					194L-G3667E	
HUVUDBRYTARE					194L-G3667F	
WAHLSCHALTER					194L-G3667G	
Red/Yellow						



IEC Load Switches  
**Bulletin 194E**  
 25 Amps to 100 Amps

**Accessories (continued)**

Modifications for Enclosed Switches (see pages 10-9 & 10-10)

Description	Maximum Load Rating (A)	Suffix
Power Pole	25	-NP
	32	
	40	
	63	
	80	
	100	
Auxiliary Contact (1 N.O. + 1 N.C.)	25/32	-P11
	40/63	
	80/100	
Auxiliary Contact (1 N.C.E.B.)	25/32	-PD10
	40/63	
	80/100	
Auxiliary Contact (1 N.O.E.M. + 1 N.C.L.B.)	25/32	-PL11
	40/63	
	80/100	
Earthing Terminal (Ground)	25/32	-PE
	40/63	
	80/100	
Neutral Terminal (Unswitched)	25/32	-TN
	40/63	
	80/100	

**Operating Shafts**

	Lengths	Construction	Use with Catalogue Number	Catalogue Number ❶
 Standard Shaft	34 mm (1-11/32 in.)	Plastic	194E-E...	194L-G3380
		Metal		194E-G3688
 Interlock Shaft	44 mm (1-47/64 in.)	Plastic	194E-A...	194L-G2830
		Metal		194E-G3687
	52 mm (2-3/64 in.)	Plastic		194L-G3194
		Metal		194E-G3707
	57 mm (2-15/64 in.)	Plastic		194L-G3195

**Shaft Extension Kits**

	Lengths	Use with Catalogue Number	Catalogue Number
 Shaft Extension	24 mm (15/16 in.) Per Extension Sold in Qty. of 10 Per Pkg.	194E-A...	194L-G2853

**Metal Shaft Extensions — with Padlock Provision in OFF Position**

	Lengths	Use with Catalogue Number	Catalogue Number
	110 mm...235 mm (4-21/64 in. ... 9-1/4 in.)	194E-A...	194L-G3393
	230 mm...350 mm (9-3/64 in.... 13-51/64 in.)		194L-G3394

❶ Order in quantities of 100 (50 shafts per package).

**Accessories (continued)**

**Metal Shaft Adaptor Kits — For use with 194R Type 4/4X Handles**

	Description	Use with Catalogue Number	Catalogue Number
	Kit includes bezel adapter and 194R-R1 operating shaft. Operating handle (Catalogue Number 194R-HS4) must be ordered separately.	194E-A	194E-G3675

	Accessory Description	Package Quantity	Catalogue Number
	Locking Ring Wrench For Central-Fixing Handles	1	800E-AW1
	Control Knob, Black, with Locking Facility	10	194L-G2864N
	Control Knob, Red, with Locking Facility		194L-G2864R
	Control Knob, Type P Control Knob, Black, 31 mm (1-7/32 in.) Diameter	50	194L-G2888N
	Control Knob, Red, 31 mm (1-7/32 in.) Diameter		194L-G2888R
 	Control Knob, Black, L = 37.5 mm (1-31/64 in.)	50	194L-G3154N
	Control Knob, Black, L = 48 mm (1-57/64 in.)		194L-G3155N
	Control Knob, Black, L = 37.5 mm (1-31/64 in.)		194L-G3154R
	Control Knob, Black, L = 48 mm (1-57/64 in.)		194L-G3155R
<i>Standard Black Control Knob</i> <i>Rectangular Front Frame</i>	Rectangular Front Frame with Blank Nameplate L = 48 mm x 62 mm (1-57/64 in. x 2-7/16 in.)	10	194L-G3196
	Rectangular Front Frame with Blank Nameplate L = 64 mm x 78 mm (2-33/64 in. x 3-5/64 in.)		194L-G3197
	Metal Shaft Extension	10	194L-G3399

IEC Load Switches  
**Bulletin 194E**  
 25 Amps to 100 Amps

Accessories (continued)

Shaft for Enclosures

Enclosure Type	Suitable For			Suitable For		
	194L (Base-Mounted Switches)	No. of Contacts	Shaft	Use with 194E Switch	No. of Poles	Shaft Required
194L-G3572 194L-G3576 (95 x 150 x 86 mm)	194L-A12(16) 194L-A12(16) 194L-A20(25) 194L-A20(25)	1/2 3/4 1/2 3/4	194L-G3195 Standard 194L-G3194 Standard	194E-A25(32)	3 and 4	194L-G3194
194L-G3573 194L-G3577 (95 x 150 x 111 mm)	194L-A12(16) 194L-A12(16) 194L-A12(16) 194L-A20(25) 194L-A20(25)	5/6 7/8 9/10 5/6 7/8	194L-G3195 194L-G3194 Standard 194L-G3194 Standard	—	—	—
194E-G3663 194E-G3664 (125 x 180 x 105 mm)	—	—	—	194E-A40(63) 194E-A25(32)	3 and 4 6	194L-G3194 Standard
194E-G3665 194E-G3666 (175 x 230 x 120 mm)	—	—	—	194E-A80(100) 194E-A40(63)	3 and 4 6	194E-G3707 Standard

Possible Accessory Combinations in Enclosure

Enclosure Type	Switch	No. of Poles	Shaft	Aux. Contacts (single or double)	Addition- al Pole Block	On Switch		On Enclosure	
						Neutral Termin- al Block	Ground Termin- al Block	Neutral Termin- al Block	Ground Termin- al Block
194L-G3572 194L-G3576 (95 x 150 x 86 mm)	194E-A25(32)	3	194L-G3194	X	X				
				X		X			
				X			X		
					X		X		
				X				X	
				X					X
194E-G3663 194E-G3664 (125 x 180 x 105 mm)	194E-A40(63)	3	194L-G3194	X	X			X	X
				X		X		X	X
				X			X	X	X
					X		X	X	X
					X		X	X	X
	194E-A25(32)	6	Standard				X	X	
194E-G3665 194E-G3666 (175 x 230 x 120 mm)	194E-A80(100)	3	194E-G3707	X	X			X	X
				X		X		X	X
				X			X	X	X
					X		X	X	X
					X		X	X	X
	194E-A40(63)	6	Standard	1L+1R			X	X	

**Specifications**

**Electrical Ratings**

Performance Data		25 A	32 A	40 A	63 A	80 A	100 A	Aux. Contacts		
		IEC Applications								
Rated operational voltage ( $U_e$ ): IEC ①		[V]	690	690	690	690	690	690		
Rated operational voltage ( $U_e$ ): UL, CSA		[V]	600	600	600	600	600	600		
Rated insulation voltage ( $U_i$ ): IEC/UL, CSA		[V]	690/600	690/600	690/600	690/600	690/600	690/600		
Rated impulse voltage ( $U_{imp}$ ): UL, CSA		[kV]	8	8	8	8	8	8		
Test voltage, ( $U_i$ ) 1 minute		[kV]	2.5	2.5	2.5	2.5	2.5	2.5		
Lost power per pole		w	1.0	1.5	1.6	2.4	3.6	5.5		
<b>Rated frequency</b>		[Hz]	50/60	50/60	50/60	50/60	50/60	50/60		
Conventional free air thermal current $I_{th}$ ①		[A]	30	40	50	75	100	10 ②		
Conventional enclosed thermal current $I_{th}$ ①		[A]	25	32	40	63	80	100		
<b>Rated current <math>I_e</math> ①</b>										
AC-1/	Non inductive or only slightly inductive loads	[A]	25	32	40	63	80	100	10	
AC-21A	Switching of resistive loads with slight overload									
<b>Rated power <math>P_e</math></b>										
AC-23A	Occasional switching of 3 $\phi$ motors and other highly inductive loads (criterion for selecting main switches)	230V [kW]	7.5	7.5	15	18.5	22	30	—	
		400V [kW]	11	15	18.5	22	37	45	—	
		690V [kW]	11	15	18.5	22	37	45	—	
AC-3	Squirrel-cage motors; starting and stopping of running motors	230V [kW]	5.5	7.5	11	15	18.5	22	—	
		400V [kW]	7.5	11	15	18.5	30	37	—	
		690V [kW]	7.5	11	15	18.5	22	22	—	
Short circuit current (coordination type 2)										
Rated conditional short-circuit current		400/415V [kA]	20	15	20	15	30	25	—	
Maximum fuse rating of circuit (type g, G)		[A]	25	25	50	63	80	100	—	
Rated short-time current $1c_w$ , 1s		[A]	900	900	1300	1300	2500	2500	—	
<b>Rated breaking capacity AC23A (cos<math>\phi</math> 0.45)</b>										
		230V [A]	204	204	484	484	780	780	—	
		400V [A]	232	232	336	336	680	680	—	
		690V [A]	136	136	196	196	376	376	—	
<b>DC switching capacity</b>										
<b>Rated current <math>I_e</math></b>										
DC-21A	For resistive loads, $T \leq 1$ ms $U_e$ max = 660V	1-pole	48V [A]	25	32	40	63	80	100	—
			110V [A]	6	6	8	10	16	0	
			220V [A]	1	1	1.5	1.5	3	3	
		2-poles in series	96V [A]	25	32	40	63	80	100	—
			110V [A]	23	25	32	50	70	80	
			220V [A]	5	6	8	10	16	20	
		3-poles in series	440V [A]	1	1	1.5	1.5	3	3	—
			600V [A]	0.6	0.6	0.8	0.8	1	1	
			110V [A]	25	32	40	63	80	100	
		3-poles in series	220V [A]	13	15	20	28	50	63	—
			440V [A]	22	2.2	3.6	3.6	6.5	6.5	
			600V [A]	1.5	0.6	2	2	3	3	
<b>Rated power <math>P_e</math></b>										
DC-23A, DC-3, DC-5	For inductive loads, $T \leq 15$ ms	3-poles in series	90V [kW]	1.3	1.5	2.9	4.1	5.1	7.2	—
			110V [kW]	1.1	1.3	2.2	3.3	5.5	7	
			220V [kW]	0.9	1.1	1.7	2	3.5	4.4	
			440V [kW]	0.6	0.6	0.9	0.9	1.1	1.1	
			600V [kW]	0.4	0.4	0.5	0.5	0.9	0.9	

① See conformity to standards listed on page.

② Suitable also for SEV 500.



**IEC Load Switches**  
**Bulletin 194E**  
**25 Amps to 100 Amps**

**Specifications**

**Electrical Ratings (continued)**

Performance Data			25 A	32 A	40 A	63 A	80 A	100 A	Aux. Contacts		
UL/CSA Applications											
Continuous current		[A]	25	32	40	63	80	100	—		
Heavy Pilot Duty		[AC]	A600	A600	—	—	—	—	A600		
Standard Duty		[DC]	—	—	—	—	—	—	Q600		
single-phase (2-poles)	120V, 1P	FLA	9.8	16	24	34	56	80	—		
		HP	0.5	1	2	3	5	7.5			
	240V, 1P	FLA	10	12	17	28	50	68			
		HP	1.5	2	3	5	10	15			
	480V, 1P	FLA	8.5	14	21	26	34	55			
		HP	3	5	7.5	10	15	25			
	600V, 1P	FLA	6.8	11.2	16	20	27	44			
		HP	3	5	7.5	10	15	25			
	three-phase	120V, 3P	FLA	13.6	19.2	28	40	56		84	—
			HP	2	3	5	7.5	10		15	
		240V, 3P	FLA	15.2	22	28	42	68		80	
			HP	5	7.5	10	15	25		30	
480V, 3P		FLA	14	21	27	34	52	65			
		HP	10	15	20	25	40	50			
600V, 3P		FLA	11	17	22	27	52	52			
		HP	10	15	20	25	50	50			

**Mechanical Data**

Performance Data			25 A	32 A	40 A	63 A	80 A	100 A	Aux. Contacts
Protection class according to IEC 529									
Motor rating 60 Hz									
actuators			IP65	IP65	IP65	IP65	IP65	IP65	IP65
switch bodies			IP20	IP20	IP20	IP20	IP20	IP20	IP20
Mechanical life	[million operations]		0.2	0.2	0.2	0.2	0.2	0.2	0.2
Max wire gauges									
Terminal size per IEC 947-1									
fine strands	1 conductor	mm <sup>2</sup>	1...10	1...10	2.5...16	2.5...16	4...35	4...35	0.5...2.5
rigid wire	1 conductor	mm <sup>2</sup>	1.5...16	1.5...16	2.5...25	2.5...25	4...50	4...50	0.75...2.5
Wire gauges according to UL/CSA	[AWG]		14/8	14/8	12/4	12/4	10/1	10/1	18/14

**Environmental Data**

Storage		−40...+80°C (−40...+176°F)
Operation		−25...+60°C (−13...+140°F)

**Approximate Dimensions—mm (inches)**

Dimensions are not intended to be used for manufacturing purposes.

**Front Installation Catalogue Number 194E-E...**

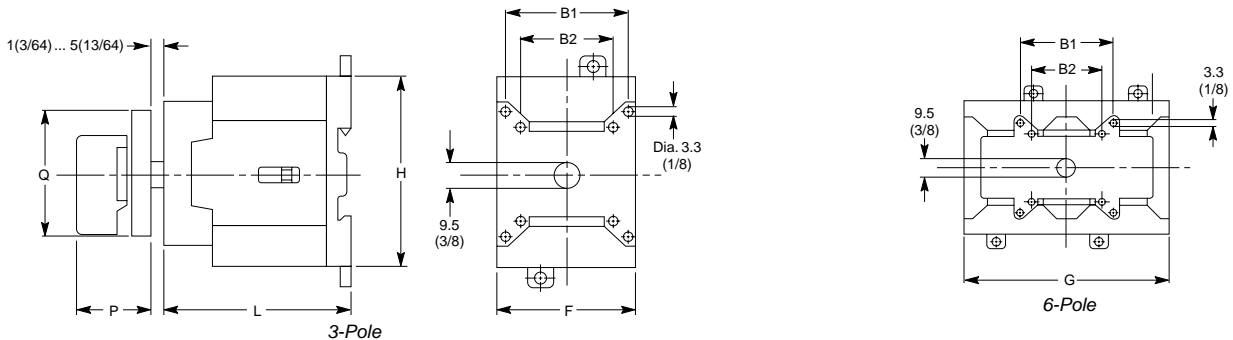

Actuators		
Catalogue Number	P	Q
194L-HE4A	28 (1-7/64)	48 x 48 (1-57/64 x 1-57/64)
194L-HE4I	28 (1-7/64)	48 x 48 (1-57/64 x 1-57/64)
194L-HE4S	28 (1-7/64)	48 x 62 (1-57/64 x 2-7/16)
194L-HE6A	28 (1-7/64)	64 x 64 (2-33/64 x 3-5/64)
194L-HE6I	28 (1-7/64)	64 x 64 (2-33/64 x 3-5/64)
194L-HE6S	28 (1-7/64)	64 x 78 (2-33/64 x 3-5/64)
194L-HE6N	34 (1-11/32)	67 x 67 (2-41/64 x 2-41/64)
194L-HE6G	34 (1-11/32)	67 x 67 (2-41/64 x 2-41/64)

Switch Body						
Use with Catalogue Number	B1 <sup>①</sup>	B2	F	H	L	G
194E-E25/32	—	36 (1-27/64)	45 (1-25/32)	64 (2-33/64)	60 (2-3/8)	90 (3-1/2)
194E-E40/63	48 (1-57/64)	36 (1-27/64)	54 (2-1/8)	72 (2-27/32)	74 (2-29/32)	108 (4-1/4)
194E-E80/100	48 (1-57/64)	36 (1-27/64)	72 (2-27/32)	90 (3-35/64)	90 (3-35/64)	144 (5-11/16)

① Does not apply to 194E-40/63A, 6-pole switches.

**Catalogue Number 194E-E Switch Body with Catalogue Number 194L-HCA Actuator for Central Mounting**

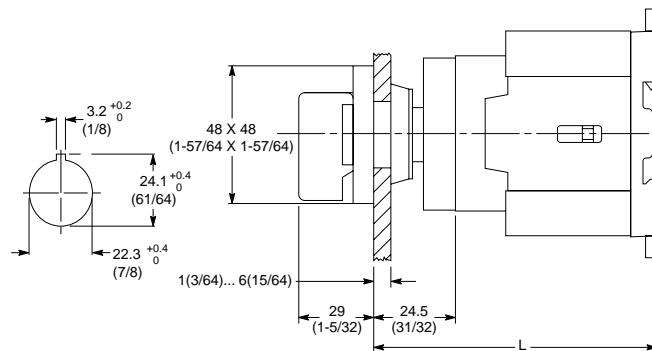

Type	L
194E-E25/32	84.5 (3-21/64)
194E-E40/63	98.5 (3-7/8)
194E-E80/100	114.5 (4-33/64)

IEC Load Switches  
**Bulletin 194E**  
 25 Amps to 100 Amps

**Approximate Dimensions—mm (inches)**

Dimensions are not intended to be used for manufacturing purposes.

Base Mounting Catalogue Number 194E-A...

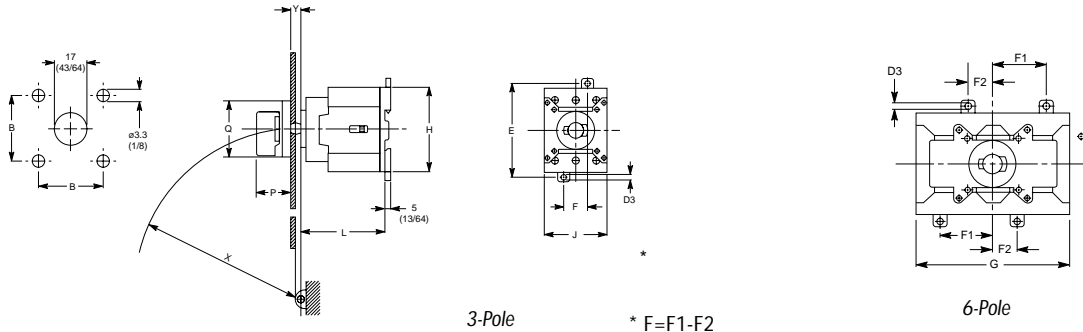

Actuators		
Catalogue Number	P	Q
194L-HE4A	28 (1-7/64)	48 x 48 (1-57/64 x 1-57/64)
194L-HE4I	28 (1-7/64)	48 x 48 (1-57/64 x 1-57/64)
194L-HE4S	28 (1-7/64)	48 x 62 (1-57/64 x 2-7/16)
194L-HE6A	28 (1-7/64)	64 x 64 (2-33/64 x 3-5/64)
194L-HE6I	28 (1-7/64)	64 x 64 (2-33/64 x 3-5/64)
194L-HE6S	28 (1-7/64)	64 x 78 (2-33/64 x 3-5/64)
194L-HE6N	34 (1-11/32)	67 x 67 (2-41/64 x 2-41/64)
194L-HE6G	34 (1-11/32)	67 x 67 (2-41/64 x 2-41/64)

Cover Requirements				
Use with Catalogue Number	Y min.	X ≥	Y max.	X ≥
194E-A25/32	5 (13/64)	142 (5-19/32)	9.5 (3/8)	90 (3-35/64)
194E-A40/63	2.5 (7/64)	150 (5-29/32)	9.5 (3/8)	90 (3-35/64)
194E-A80/100	2.5 (7/64)	150 (5-29/32)	9.5 (3/8)	90 (3-35/64)

Switch Body								
Use with Cat. Number	D3	E	F1	F2	G	H	L	J
194E-A25/32	4.5 (3/16)	70 (2-49/64)	30 (1-3/16)	15 (19/32)	90 (3-1/2)	64 (2-33/64)	84 (3-5/16)	45 (1-25/32)
194E-A40/63	4.5 (3/16)	80 (3-5/32)	37 (1-15/32)	17 (43/64)	108 (4-1/4)	72 (2-27/32)	98 (3-55/64)	54 (2-1/8)
194E-A80/100	5.6 (7/32)	95 (3-3/4)	48.5 (1-29/32)	23.5 (59/64)	144 (5-11/16)	90 (3-35/64)	114 (4-1/2)	72 (2-27/32)

**Approximate Dimensions—mm (inches)**

Dimensions are not intended to be used for manufacturing purposes.

**Base Mounting Catalogue Number 194E-A...**

*Catalogue Number 194E-A... Switch Body with Catalogue Number 194L-G2853 Shaft Extension*

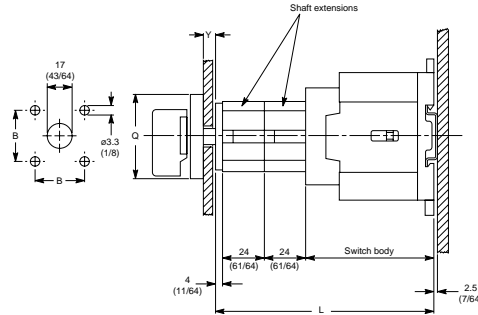

L	Switch Body		
	Catalogue Number		
	194E-A 25/32	194E-A 40/63	194E-A 80/100
with 1 shaft extension	88 (3-15/32)	102 (4-1/32)	118 (4-21/32)
with 2 shaft ext.	112 (4-27/64)	126 (4-31/32)	142 (15-19/32)
with 3 shaft ext.	136 (5-23/64)	150 (5-29/32)	166 (6-35/64)
with 4 shaft ext.	160 (6-5/16)	174 (6-55/64)	190 (7-31/64)
with 5 shaft ext.	184 (7-1/4)	198 (7-51/64)	214 (8-7/16)
with 6 shaft ext.	208 (8-13/64)	222 (8-3/4)	238 (9-3/8)

Shaft	Y	Actuators		
		Type	B	Q
194L-G2830	2.5...9.5 (7/64...3/8)	194L-HE4A	36 (1-27/64)	48 x 48 (1-57/64 x 1-57/64)
194L-G3194	9...18 (23/64...23/32)	194L-HE4I	36 (1-27/64)	48 x 48 (1-57/64 x 1-57/64)
194L-G3195	14...23 (9/16)...(29/32)	194L-HE6A	48 (1-57/64)	64 x 64 (2-33/64 x 2-33/64)
		194L-HE6I	48 (1-57/64)	64 x 64 (2-33/64 x 2-33/64)
		194L-HE6N	48 (1-57/64)	67 x 67 (2-41/64 x 2-41/64)
		194L-HE6G	48 (1-57/64)	67 x 67 (2-41/64 x 2-41/64)

**Front Installation Catalogue Number 194E-A...**

*Catalogue Number 194E-A Switch Body with Metal Shaft Extension*

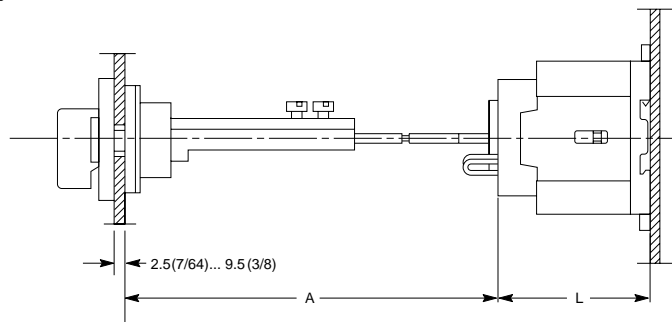

Catalogue Number	A
194L-G3393	110...235 (4-11/32...9-1/4)
194L-G3394	230...350 (9-1/16...13-25/32)

Catalogue Number	L ①
194E-A25/32	60 (2-3/8)
194E-A40/63	74 (2-59/64)
194E-A80/100	90 (3-35/64)

① +2.5 (7/64) [DIN 46 277] 35 (1-3/8) Rails.

**IEC Load Switches**  
**Bulletin 194E**  
**25 Amps to 100 Amps**

**Approximate Dimensions—mm (inches)**

Dimensions are not intended to be used for manufacturing purposes.

**Base and Front Installation**

*Catalogue Number 194E... with Auxiliary Contact Block Installed*

Contacts	M
1 N.O. + 1 N.C.	9 (23/64)
2 N.O. + 2 N.C.	18 (23/32)

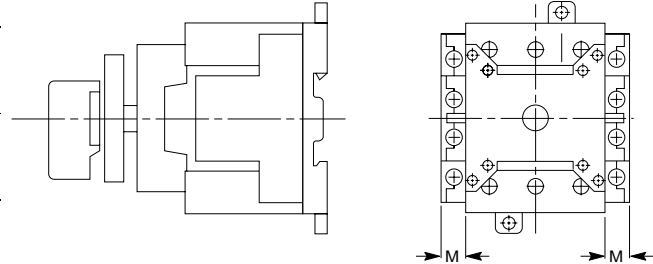

*Catalogue Number 194E... with 4-Pole, Ground and Neutral Terminals*

Catalogue Number	M
194E-25/32	14 (9/16)
194E-40/63	17.5 (11/16)
194E-80/100	22 (7/8)

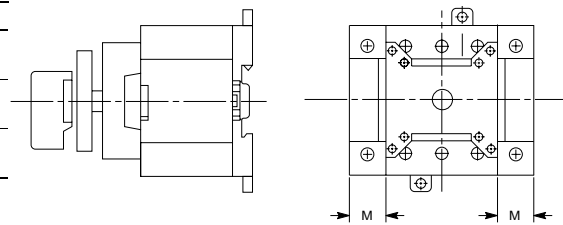

**Approximate Dimensions—mm (inches)**

Dimensions are shown in millimetres (inches). Dimensions are not intended to be used for manufacturing purposes.

**Base Mounting Catalogue Number 194E-A...**

*Thermoplastic Enclosures*

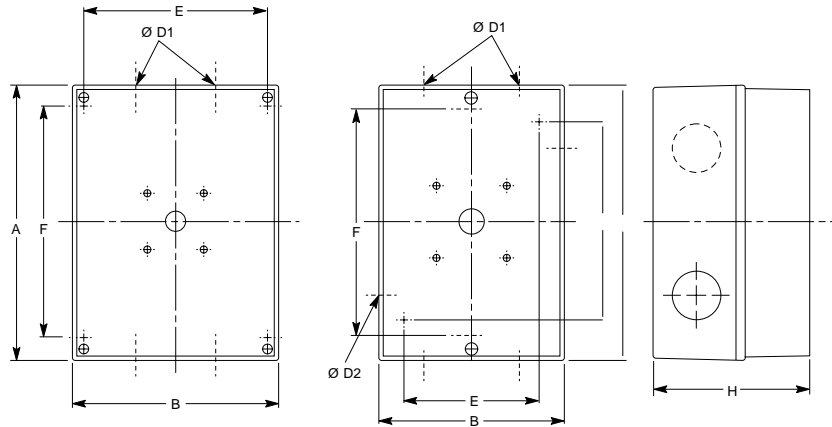

Complete Switches		Enclosures		A	B	ØD1	ØD2	E	F	H
Catalogue Number	Poles	ABS	Noryl							
		Catalogue Number								
194E-Y25/32	3 and 4	194L-G3572	194L-G3576	150 (5-29/32)	95 (3-3/4)	22.5 (57/64)	22.5 (57/64)	60 (2-3/8)	115 (4-17/32)	86 (3-3/8)
	6	194E-G3663	194E-G3664	180 (7-3/32)	125 (4-59/64)	37.5 (1-31/64)	—	—	145 (5-23/32)	105 (4-1/8)
194E-Y40/63	3 and 4	194E-G3663	194E-G3664	180 (7-3/32)	125 (4-59/64)	37.5 (1-31/64)	—	—	145 (5-23/32)	105 (4-1/8)
	6	194E-G3665	194E-G3666	230 (9-1/16)	175 (6-57/64)	47.5 (1-7/8)	—	155 (6-3/32)	195 (4-11/16)	120 (4-47/64)
194E-Y80/100	3 and 4	194E-G3665	194E-G3666	230 (9-1/16)	175 (6-57/64)	47.5 (1-7/8)	—	155 (6-3/32)	195 (4-11/16)	120 (4-47/64)

No. of Extensions	Catalogue Number 194E-A 20/32...	Catalogue Number 194E-A 40/63...	Catalogue Number 194E-A 80/00...
	Inside Enclosure Depth		
with 1 extension	96 (3-25/32)	107 (4-7/32)	114 (4-31/64)
with 2 extensions	120 (4-23/32)	131 (5-5/32)	138 (5-7/16)
with 3 extensions	144 (5-43/64)	155 (6-7/64)	162 (6-3/8)
with 4 ① extensions	168 (6-39/64)	179 (7-3/64)	186 (7-21/64)
with 5 ① extensions	192 (7-9/16)	203 (8)	210 (8-17/64)
with 6 ① extensions	216 (8-1/2)	227 (8-15/16)	234 (9-7/32)

① +2 When more than 4 modules are used, attach the first one to the switch body using the screws supplied with the extension (Catalogue Number: 194L-G2853).

IEC Load Switches  
**Bulletin 194E**  
 25 Amps to 100 Amps

**Approximate Dimensions—mm (inches)**

Dimensions are not intended to be used for manufacturing purposes.

**Enclosed Switches**

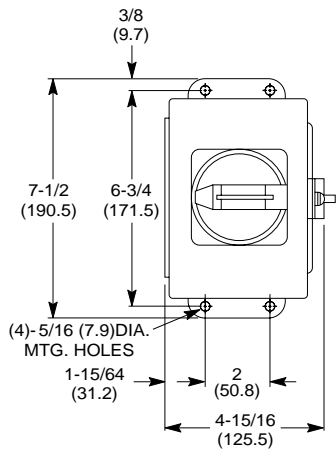

Dim Ref. A1  
 194E-CA20...63, 194E-FA20...63, 194E-AA20...63

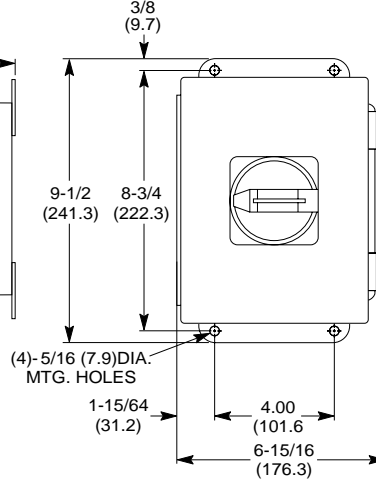
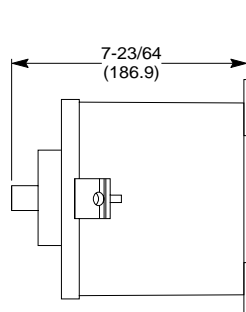

Dim Ref. B1  
 194E-CA80...00, 194E-FA80...00, 194E-AA80...00

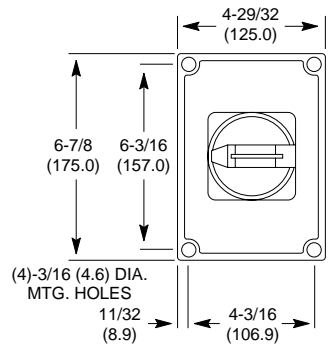

Dim Ref. C1  
 194E-KA20...63

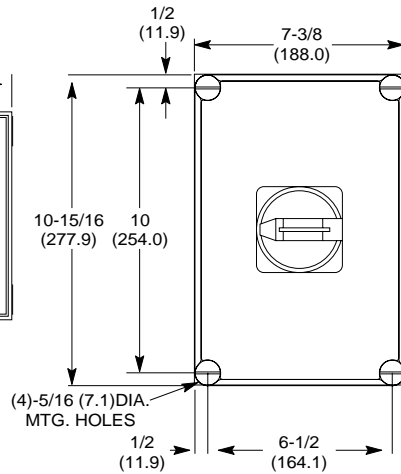
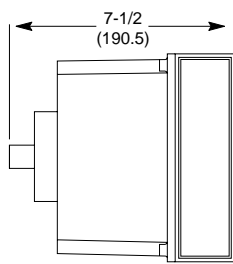

Dim Ref. B1  
 194E-KA80...00

