

Installation Instructions

Original Instructions



Allen-Bradley

by ROCKWELL AUTOMATION

FLEX I/O Digital DC Output Modules

Catalog Numbers 1794-OB8, 1794-OB8EP, 1794-OB16, 1794-OB16P, 1794-OB32P

Topic	Page
Summary of Changes	1
Overview	5
Install Your Module	5
Specifications	9

Summary of Changes

This publication contains the following new or updated information. This list includes substantive updates only and is not intended to reflect all changes.

Topic	Page
Updated template	throughout
Updated UK and European Hazardous Location Approval	4
Updated IEC Hazardous Location Approval	4
Updated Special Conditions for Safe Use	4
Updated General Specifications	11
Updated Environmental Specifications	12
Updated Certifications	12



ATTENTION: Read this document and the documents listed in the Additional Resources section about installation, configuration and operation of this equipment before you install, configure, operate or maintain this product. Users are required to familiarize themselves with installation and wiring instructions in addition to requirements of all applicable codes, laws, and standards.

Activities including installation, adjustments, putting into service, use, assembly, disassembly, and maintenance are required to be carried out by suitably trained personnel in accordance with applicable code of practice. If this equipment is used in a manner not specified by the manufacturer, the protection provided by the equipment may be impaired.

注意: 在安装、配置、操作和维护本产品前, 请阅读本文档以及“其他资源”部分列出的有关设备安装、配置和操作的相应文档。除了所有适用规范、法律和标准的相关要求之外, 用户还必须熟悉安装和接线说明。

安装、调整、投运、使用、组装、拆卸和维护等各项操作必须由经过适当训练的专业人员按照适用的操作规范实施。

如果未按照制造商指定的方式使用该设备, 则可能会损害设备提供的保护。

ATENCIÓN: Antes de instalar, configurar, poner en funcionamiento o realizar el mantenimiento de este producto, lea este documento y los documentos listados en la sección Recursos adicionales acerca de la instalación, configuración y operación de este equipo. Los usuarios deben familiarizarse con las instrucciones de instalación y cableado y con los requisitos de todos los códigos, leyes y estándares vigentes. El personal debidamente capacitado debe realizar las actividades relacionadas a la instalación, ajustes, puesta en servicio, uso, ensamblaje, desensamblaje y mantenimiento de conformidad con el código de práctica aplicable. Si este equipo se usa de una manera no especificada por el fabricante, la protección provista por el equipo puede resultar afectada.

ATENÇÃO: Leia este e os demais documentos sobre instalação, configuração e operação do equipamento que estão na seção Recursos adicionais antes de instalar, configurar, operar ou manter este produto. Os usuários devem se familiarizar com as instruções de instalação e fiação além das especificações para todos os códigos, leis e normas aplicáveis.

É necessário que as atividades, incluindo instalação, ajustes, colocação em serviço, utilização, montagem, desmontagem e manutenção sejam realizadas por pessoal qualificado e especializado, de acordo com o código de prática aplicável.

Caso este equipamento seja utilizado de maneira não estabelecida pelo fabricante, a proteção fornecida pelo equipamento pode ficar prejudicada.

ВНИМАНИЕ: Перед тем как устанавливать, настраивать, эксплуатировать или обслуживать данное оборудование, прочитайте этот документ и документы, перечисленные в разделе «Дополнительные ресурсы». В этих документах изложены сведения об установке, настройке и эксплуатации данного оборудования. Пользователи обязаны ознакомиться с инструкциями по установке и прокладке соединений, а также с требованиями всех применимых норм, законов и стандартов.

Все действия, включая установку, наладку, ввод в эксплуатацию, использование, сборку, разборку и техническое обслуживание, должны выполняться обученным персоналом в соответствии с применимыми нормами и правилами.

Если оборудование используется не предусмотренным производителем образом, защита оборудования может быть нарушена.

注意: 本製品を設置、構成、稼働または保守する前に、本書および本機器の設置、設定、操作についての参考資料の該当箇所に記載されている文書に目を通してください。ユーザは、すべての該当する条例、法律、規格の要件に加えて、設置および配線の手順に習熟している必要があります。

設置調整、運転の開始、使用、組立て、解体、保守を含む諸作業は、該当する実施規則に従って訓練を受けた適切な作業員が実行する必要があります。

本機器が製造メーカーにより指定されていない方法で使用されている場合、機器により提供されている保護が損なわれる恐れがあります。

ACHTUNG: Lesen Sie dieses Dokument und die im Abschnitt „Weitere Informationen“ aufgeführten Dokumente, die Informationen zur Installation, Konfiguration und Bedienung dieses Produkts enthalten, bevor Sie dieses Produkt installieren, konfigurieren, bedienen oder warten. Anwender müssen sich neben den Bestimmungen aller anwendbaren Vorschriften, Gesetze und Normen zusätzlich mit den Installations- und Verdrahtungsanweisungen vertraut machen.

Arbeiten im Rahmen der Installation, Anpassung, Inbetriebnahme, Verwendung, Montage, Demontage oder Instandhaltung dürfen nur durch ausreichend geschulte Mitarbeiter und in Übereinstimmung mit den anwendbaren Ausführungsvorschriften vorgenommen werden.

Wenn das Gerät in einer Weise verwendet wird, die vom Hersteller nicht vorgesehen ist, kann die Schutzfunktion beeinträchtigt sein.

ATTENTION : Lisez ce document et les documents listés dans la section Ressources complémentaires relatifs à l'installation, la configuration et le fonctionnement de cet équipement avant d'installer, configurer, utiliser ou entretenir ce produit. Les utilisateurs doivent se familiariser avec les instructions d'installation et de câblage en plus des exigences relatives aux codes, lois et normes en vigueur.

Les activités relatives à l'installation, le réglage, la mise en service, l'utilisation, l'assemblage, le démontage et l'entretien doivent être réalisées par des personnes formées selon le code de pratique en vigueur.

Si cet équipement est utilisé d'une façon qui n'a pas été définie par le fabricant, la protection fournie par l'équipement peut être compromise.

주의: 본 제품 설치, 설정, 작동 또는 유지 보수하기 전에 본 문서를 포함하여 설치, 설정 및 작동에 관한 참고 자료 섹션의 문서들을 반드시 읽고 숙지하십시오. 사용자는 모든 관련 규정, 법규 및 표준에서 요구하는 사항에 대해 반드시 설치 및 배선 지침을 숙지해야 합니다.

설치, 조정, 가동, 사용, 조립, 분해, 유지보수 등 모든 작업은 관련 규정에 따라 적절한 교육을 받은 사용자들 통해서만 수행해야 합니다.

본 장비를 제조사가 명시하지 않은 방법으로 사용하면 장비의 보호 기능이 손상될 수 있습니다.

ATTENZIONE Prima di installare, configurare ed utilizzare il prodotto, o effettuare interventi di manutenzione su di esso, leggere il presente documento ed i documenti elencati nella sezione "Altre risorse", riguardanti l'installazione, la configurazione ed il funzionamento dell'apparecchiatura. Gli utenti devono leggere e comprendere le istruzioni di installazione e cablaggio, oltre ai requisiti previsti dalle leggi, codici standard applicabili.

Le attività come installazione, regolazioni, utilizzo, assemblaggio, disassemblaggio e manutenzione devono essere svolte da personale adeguatamente addestrato, nel rispetto delle procedure previste.

Qualora l'apparecchio venga utilizzato con modalità diverse da quanto previsto dal produttore, la sua funzione di protezione potrebbe venire compromessa.

DİKKAT: Bu ürünün kurulumu, yapılandırılması, işletilmesi veya bakımı öncesinde bu dokümanı ve bu ekipmanın kurulumu, yapılandırılması ve işletimi ile ilgili ilave Kaynaklar bölümünde yer listelenmiş dokümanları okuyun. Kullanıcılar yürürlükteki tüm yönetmelikler, yasal ve standartların gereksinimlerine ek olarak kurulum ve kablolama talimatlarını da öğrenmek zorundadır.

Kurulum, ayarlama, hizmete alma, kullanma, parçaları birleştirme, parçaları sökme ve bakım gibi aktiviteler sadece uygun eğitimli almış kişiler tarafından yürürlükteki uygulama yönetmeliklerine uygun şekilde yapılabilir.

Bu ekipman üretici tarafından belirlenmiş amacın dışında kullanılırsa, ekipman tarafından sağlanan koruma bozulabilir.

注意事項: 在安装、設定、操作或維護本產品前, 請先閱讀此文件以及列於「其他資源」章節中有關安裝、設定與操作此設備的文件。使用者必須熟悉安裝和配線指示, 並符合所有法規、法律和標準要求。

包括安裝、調整、交付使用、使用、組裝、拆卸和維護等動作都必須交由已經過適當訓練的人員進行, 以符合適用的實作法規。

如果將設備用於非製造商指定的用途時, 可能會造成設備所提供的保護功能受損。

POZOR: Než začnete instalovat, konfigurovat či provozovat tento výrobek nebo provádět jeho údržbu, přečtěte si tento dokument a dokumenty uvedené v části Dodatečné zdroje ohledně instalace, konfigurace a provozu tohoto zařízení. Uživatelé se musejí vedle požadavků všech relevantních vyhlášek, zákonů a norem nutně seznámit také s pokyny pro instalaci a elektrické zapojení.

Činnosti zahrnující instalaci, nastavení, uvedení do provozu, užívání, montáž, demontáž a údržbu musí vykonávat vhodné proškolený personál v souladu s příslušnými prováděcími předpisy.

Pokud se toto zařízení používá způsobem neodpovídajícím specifikaci výrobce, může být narušena ochrana, kterou toto zařízení poskytuje.

UWAGA: Przed instalacją, konfiguracją, użytkowaniem lub konserwacją tego produktu należy przeczytać niniejszy dokument oraz wszystkie dokumenty wymienione w sekcji Dodatkowe źródła omawiające instalację, konfigurację i procedury użytkowania tego urządzenia. Użytkownicy mają obowiązek zapoznać się z instrukcjami dotyczącymi instalacji oraz oprzewodowania, jak również z obowiązującymi kodeksami, prawem i normami.

Działania obejmujące instalację, regulację, przekazanie do użytkowania, użytkowanie, montaż, demontaż oraz konserwację muszą być wykonywane przez odpowiednio przeszkolony personel zgodnie z obowiązującym kodeksem postępowania.

Jeśli urządzenie jest użytkowane w sposób inny niż określony przez producenta, zabezpieczenie zapewniane przez urządzenie może zostać ograniczone.

Obs: Läs detta dokument samt dokumentet, som står listat i avsnittet Övriga resurser, om installation, konfigurering och drift av denna utrustning innan du installerar, konfigurerar eller börjar använda eller utföra underhållsarbete på produkten. Användare måste bekanta sig med instruktioner för installation och kabeldragning, förutom krav enligt gällande koder, lagar och standarder.

Åtgärder som installation, justering, service, användning, montering, demontering och underhållsarbete måste utföras av personal med lämplig utbildning enligt lämpligt bruk.

Om denna utrustning används på ett sätt som inte anges av tillverkaren kan det hända att utrustningens skyddsanordningar försätts ur funktion.

LET OP: Lees dit document en de documenten die genoemd worden in de paragraaf Aanvullende informatie over de installatie, configuratie en bediening van deze apparatuur voordat u dit product installeert, configureert, bedient of onderhoudt. Gebruikers moeten zich vertrouwd maken met de installatie en de bedradingsinstructies, naast de vereisten van alle toepasselijke regels, wetten en normen.

Activiteiten zoals het installeren, afstellen, in gebruik stellen, gebruiken, monteren, demonteren en het uitvoeren van onderhoud mogen uitsluitend worden uitgevoerd door hiervoor opgeleid personeel en in overeenstemming met de geldende praktijkregels.

Indien de apparatuur wordt gebruikt op een wijze die niet is gespecificeerd door de fabrikant, dan bestaat het gevaar dat de beveiliging van de apparatuur niet goed werkt.

Environment and Enclosure



ATTENTION: This equipment is intended for use in a Pollution Degree 2 industrial environment, in overvoltage Category II applications (as defined in EN/IEC 60664-1), at altitudes up to 2000 m (6562 ft) without derating. This equipment is not intended for use in residential environments and may not provide adequate protection to radio communication services in such environments.

This equipment is supplied as open-type equipment for indoor use. It must be mounted within an enclosure that is suitably designed for those specific environmental conditions that will be present and appropriately designed to prevent personal injury resulting from accessibility to live parts. The enclosure must have suitable flame-retardant properties to prevent or minimize the spread of flame, complying with a flame spread rating of 5VA or be approved for the application if nonmetallic. The interior of the enclosure must be accessible only by the use of a tool. Subsequent sections of this publication may contain more information regarding specific enclosure type ratings that are required to comply with certain product safety certifications.

In addition to this publication, see the following:

- Industrial Automation Wiring and Grounding Guidelines, publication [1770-4.1](#), for more installation requirements.
- NEMA Standard 250 and EN/IEC 60529, as applicable, for explanations of the degrees of protection provided by enclosures.

Prevent Electrostatic Discharge



ATTENTION:

- This equipment is sensitive to electrostatic discharge, which can cause internal damage and affect normal operation. Follow these guidelines when you handle this equipment:
- Touch a grounded object to discharge potential static.
- Wear an approved grounding wriststrap.
- Do not touch connectors or pins on component boards.
- Do not touch circuit components inside the equipment.
- Use a static-safe workstation, if available.
- Store the equipment in appropriate static-safe packaging when not in use.

Special Conditions for Safe Use



ATTENTION: This product is grounded through the DIN rail to chassis ground. Use zinc plated chromate-passivated steel DIN rail to assure proper grounding. The use of other DIN rail materials (for example, aluminum or plastic) that can corrode, oxidize, or are poor conductors, can result in improper or intermittent grounding. Secure DIN rail to mounting surface approximately every 200 mm (7.8 in.) and use end-anchors appropriately. Be sure to ground the DIN rail properly.

Refer to Industrial Automation Wiring and Grounding Guidelines, Rockwell Automation publication [1770-4.1](#), for more information



ATTENTION: If this equipment is used in a manner not specified by the manufacturer, the protection provided by the equipment may be impaired.



ATTENTION:

- If this equipment is used in a manner not specified by the manufacturer, the protection provided by the equipment may be impaired.
- Read this document and the documents listed in the Additional Resources section about installation, configuration, and operation of this equipment before you install, configure, operate, or maintain this product. Users are required to familiarize themselves with installation and wiring instructions in addition to requirements of all applicable codes, laws, and standards.
- Installation, adjustments, putting into service, use, assembly, disassembly, and maintenance are required to be carried out by suitably trained personnel in accordance with applicable code of practice.
In case of malfunction or damage, no attempts at repair should be made. The module should be returned to the manufacturer for repair. Do not dismantle the module.
- Use only a soft dry anti-static cloth to wipe down equipment. Do not use any cleaning agents.



WARNING: When you insert or remove the module while backplane power is on, an electric arc can occur. This could cause an explosion in hazardous location installations.

Be sure that power is removed or the area is nonhazardous before proceeding. Repeated electric arcing causes excessive wear to contacts on both the module and its mating connector. Worn contacts may create electrical resistance that can affect module operation.



WARNING: If you insert or remove the module while backplane power is on, an electric arc can occur. This could cause an explosion in hazardous location installations.

Be sure that power is removed or the area is nonhazardous before proceeding.

UK and European Hazardous Location Approval

Approved for 1794-0B8, 1794-0B8EP, 1794-0B16 and 1794-0B16P modules.

The following applies to products marked II 3 G:

- Are Equipment Group II, Equipment Category 3, and comply with the Essential Health and Safety Requirements relating to the design and construction of such equipment given in Schedule 1 of UKEX and Annex II of EU Directive 2014/34/EU. See the UKEx and EU Declaration of Conformity at rok.auto/certifications for details.
- The type of protection is Ex ec IIC T4 Gc (1794-0B8EP) & Ex ec IIC T3 Gc (1794-0B16P) according to EN IEC 60079-0:2018 and EN IEC 60079-7:2015+A1:2018.
- The type of protection is Ex nA IIC T4 Gc (1794-0B8 & 0B16) according to EN 60079-0:2009 & EN 60079-15:2010.
- Comply to Standard EN IEC 60079-0:2018 & EN IEC 60079-7:2015+A1:2018 reference certificate number DEMKO 14 ATEX 1342501X and UL22UKEK2378X.
- Comply to Standards: EN 60079-0:2009, EN 60079-15:2010, reference certificate number LCIE 01ATEX6020X.
- Are intended for use in areas in which explosive atmospheres caused by gases, vapors, mists, or air are unlikely to occur, or are likely to occur only infrequently and for short periods. Such locations correspond to Zone 2 classification according to UKEX regulation 2016 No. 1107 and ATEX directive 2014/34/EU.

IEC Hazardous Location Approval

The following applies to products marked with IECEx certification (1794-0B8EP & 1794-0B16P):

- Are intended for use in areas in which explosive atmospheres caused by gases, vapors, mists, or air are unlikely to occur, or are likely to occur only infrequently and for short periods. Such locations correspond to Zone 2 classification to IEC 60079-0.
- The type of protection is Ex ec IIC T4 Gc (1794-0B8EP) & Ex ec IIC T3 Gc (1794-0B16P) according to IEC 60079-0 and IEC 60079-7.
- Comply to Standards IEC 60079-0, Explosive atmospheres Part 0: Equipment - General requirements, Edition 7, Revision Date 2017, IEC 60079-7, 5.1 Edition revision date 2017, Explosive atmospheres - Part 7: Equipment protection by increased safety "e", reference IECEx certificate number IECEx UL 14.0066X.





WARNING: Special Conditions for Safe Use:

- This equipment shall be mounted in an UKEX/ATEX/IECEx Zone 2 certified enclosure with a minimum ingress protection rating of at least IP54 (in accordance with EN/IEC 60079-0) and used in an environment of not more than Pollution Degree 2 (as defined in EN/IEC 60664-1) when applied in Zone 2 environments. The enclosure must be accessible only by the use of a tool.
- This equipment shall be used within its specified ratings defined by Rockwell Automation.
- Transient protection shall be provided that is set at a level not exceeding 140% of the peak rated voltage value at the supply terminals to the equipment.
- This equipment must be used only with UKEX/ATEX/IECEx certified Rockwell Automation backplanes.
- Secure any external connections that mate to this equipment by using screws, sliding latches, threaded connectors, or other means provided with this product.
- Do not disconnect equipment unless power has been removed or the area is known to be nonhazardous.
- Earthing is accomplished through mounting of modules on rail.

North American Hazardous Location Approval

The 1794-0B8, 1794-0B8EP, 1794-0B16, 1794-0B16P modules are Hazardous Location approved:

The Following Information Applies When Operating This Equipment In Hazardous Locations.	Informations sur l'utilisation de cet équipement en environnements dangereux.
<p>Products marked "CL I, DIV 2, GP A, B, C, D" are suitable for use in Class I Division 2 Groups A, B, C, D, Hazardous Locations and nonhazardous locations only. Each product is supplied with markings on the rating nameplate indicating the hazardous location temperature code. When combining products within a system, the most adverse temperature code (lowest "T" number) may be used to help determine the overall temperature code of the system. Combinations of equipment in your system are subject to investigation by the local Authority Having Jurisdiction at the time of installation.</p>	<p>Les produits marqués "CL I, DIV 2, GP A, B, C, D" ne conviennent qu'à une utilisation en environnements de Classe I Division 2 Groupes A, B, C, D dangereux et non dangereux. Chaque produit est livré avec des marquages sur sa plaque d'identification qui indiquent le code de température pour les environnements dangereux. Lorsque plusieurs produits sont combinés dans un système, le code de température le plus défavorable (code de température le plus faible) peut être utilisé pour déterminer le code de température global du système. Les combinaisons d'équipements dans le système sont sujettes à inspection par les autorités locales qualifiées au moment de l'installation.</p>
<div style="display: flex; align-items: center;">  <div> <p>WARNING: Explosion Hazard -</p> <ul style="list-style-type: none"> • Do not disconnect equipment unless power has been removed or the area is known to be nonhazardous. • Do not disconnect connections to this equipment unless power has been removed or the area is known to be nonhazardous. Secure any external connections that mate to this equipment by using screws, sliding latches, threaded connectors, or other means provided with this product. • Substitution of components may impair suitability for Class I, Division 2. </div> </div>	<div style="display: flex; align-items: center;">  <div> <p>AVERTISSEMENT: Risque d'Explosion -</p> <ul style="list-style-type: none"> • Couper le courant ou s'assurer que l'environnement est classé non dangereux avant de débrancher l'équipement. • Couper le courant ou s'assurer que l'environnement est classé non dangereux avant de débrancher les connecteurs. Fixer tous les connecteurs externes reliés à cet équipement à l'aide de vis, loquets coulissants, connecteurs filetés ou autres moyens fournis avec ce produit. • La substitution de composants peut rendre cet équipement inadapté à une utilisation en environnement de Classe I, Division 2. </div> </div>

Overview

The FLEX™ I/O Digital DC Output module mounts on a 1794 terminal base.

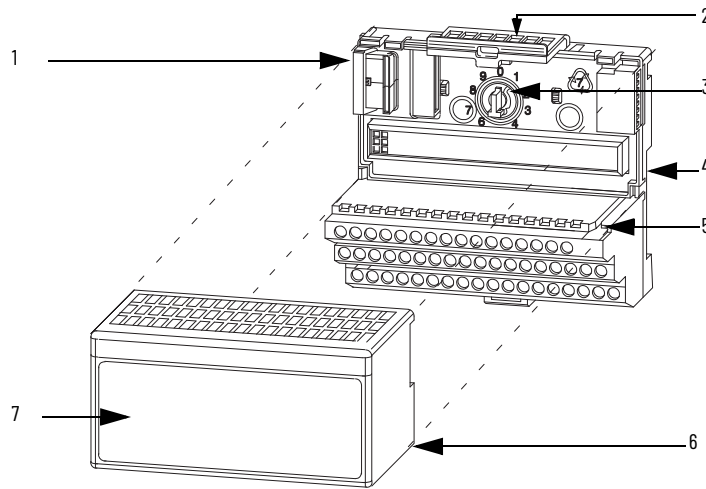

	Description		Description
1	Flexbus connectors	5	Groove
2	Latching mechanism	6	Alignment bar
3	Keyswitch	7	Module
4	Terminal base		

Install Your Module

1. Rotate the keyswitch (3) on the terminal base (4) clockwise to position 2 as required for this type of module.
2. Make sure the Flexbus connector (1) is pushed all the way to the left to connect with the neighboring terminal base/adaptor. **You cannot install the module unless the connector is fully extended.**
3. Make sure the pins on the bottom of the module are straight so they will align properly with the connector in the terminal base.
4. Position the module (7) with its alignment bar (6) aligned with the groove (5) on the terminal base.
5. Press firmly and evenly to seat the module in the terminal base unit. The module is seated when the latching mechanism (2) is locked into the module.

Connect Wiring for 1794-OB8, 1794-OB8EP, 1794-OB16, and 1794-OB16P

1. Connect individual output wiring to numbered terminals on the 0...15 row (A) as indicated in the table below **1794-OB8** - Terminals 0...7; **1794-OB16 and 1794-OB16P** - terminals 0...15; **1794-OB8EP** - even numbered terminals 0...14.
2. Connect the associated -V output common to the corresponding terminal on the 16...33 row (B) for each output as indicated in the table below. Commons are internally connected together.
1794-OB8EP - connect associated output common to odd-numbered terminals on row A or associated terminals on row (B).
3. Connect +V DC power to terminal 34 on the 34...51 row (C).
4. Connect -V DC common to terminal 16 on the 16...33 row (B).
5. If daisy chaining power to the next terminal base, connect a jumper from terminal 51 (+V DC) on this base unit to terminal 34 on the next base unit.
6. If continuing -V DC common to the next base unit, connect a jumper from terminal 33 (common) on this base unit to terminal 16 on the next base unit.

Wiring Connections for 1794-OB8, 1794-OB16, and 1794-OB16P

Used with 1794-TB2, 1794-TB3, or 1794-TB3S Terminal Base Unit

Output ⁽¹⁾	Output Terminal	Common Terminal
Output 0	A-0	B-17
Output 1	A-1	B-18
Output 2	A-2	B-19
Output 3	A-3	B-20
Output 4	A-4	B-21
Output 5	A-5	B-22
Output 6	A-6	B-23

Wiring Connections for 1794-OB8, 1794-OB16, and 1794-OB16P (Continued)

Used with 1794-TB2, 1794-TB3, or 1794-TB3S Terminal Base Unit

Output ⁽¹⁾	Output Terminal	Common Terminal
Output 7	A-7	B-24
Output 8	A-8	B-25
Output 9	A-9	B-26
Output 10	A-10	B-27
Output 11	A-11	B-28
Output 12	A-12	B-29
Output 13	A-13	B-30
Output 14	A-14	B-31
Output 15	A-15	B-32
+V DC	C-34...C-51 (C-34 and C-51 for 1794-TB2)	
Common	B-16...B-33	

(1) 1794-OB8 - Outputs 0...7; 1794-OB16 and 1794-OB16P - Outputs 0...15

Wiring Connections for 1794-OB8EP

Output	1794-TB2, 1794-TB3, 1794-TB3S		1794-TBN	
	Output Terminal	Common Terminal ⁽¹⁾	Output Terminal	Common Terminal ⁽²⁾
Output 0	A-0	A-1/B-17	B-0	C-1
Output 1	A-2	A-3/B-18	B-2	C-3
Output 2	A-4	A-5/B-19	B-4	C-5
Output 3	A-6	A-7/B-20	B-6	C-7
Output 4	A-8	A-9/B-21	B-8	C-9
Output 5	A-10	A-11/B-22	B-10	C-11
Output 6	A-12	A-13/B-23	B-12	C-13
Output 7	A-14	A-15/B-24	B-14	C-15
+V DC	C-34...C-51 (C-34 and C-51 for 1794-TB2, 1794-TBN)			
Common	B-16...B-33 (B-16 and B-33 for 1794-TBN)			

(1) 1794-TB2, 1794-TB3, 1794-TB3S - A-1, A-3, A-5, A-7, A-9, A-11, A-13, and A-15 are connected together inside the module to 24V DC common.

(2) 1794-TBN - C-1, C-3, C-5, C-7, C-9, C-11, C-13, and C-15 are connected together inside the module to 24V DC common.

1794-TB2, 1794-TB3, and 1794-TB3S Terminal Base Wiring for 1794-OB8, 1794-OB8EP, 1794-OB16, and 1794-OB16P

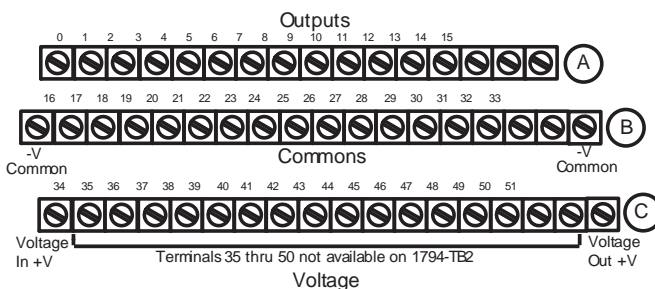

(1794-TB3 shown)

Connect -V (Supply Common) to terminal B-16.
 Use B-33 and C-51 for daisy-chaining to next terminal base unit.
 Total current draw through the terminal base is limited to 10A.
 Separate power connections to each terminal base may be necessary.

1794-TBN Terminal Base Wiring for 1794-OB8EP

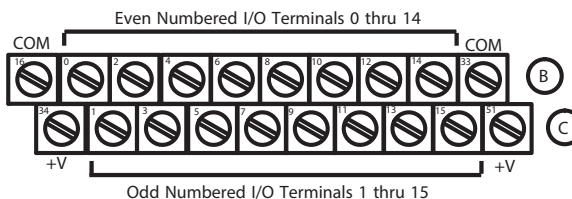

Connect -V (Supply Common) to terminal B-16.
 Connect +V (Supply +Voltage) to terminal C-34.
 Use B-33 and C-51 for daisy-chaining to next terminal base unit.
 Total current draw through the terminal base is limited to 10A.
 Separate power connections to each terminal base may be necessary.

Connect Wiring for the 1794-OB32P

1. Connect individual output wiring (OUT 0...15) to numbered terminals on the 0...15 row (A) as indicated in [Table 1](#).
2. Connect the associated power to the +V1 terminal (35, 37, 39, or 41) on the 34...51 row (C) as indicated in [Table 1](#).
3. Connect the associated output common (-V1) for OUT 0...15 to COM1 (terminal 36, 38, 40, or 42) on the 34...51 row (C).
4. Connect individual output wiring (OUT16...OUT31) to numbered terminals on the 16...33 row (B) as indicated in [Table 1](#).
5. Connect the associated power to the +V2 terminal (43, 45, 47, or 49) on the 34...51 row (C) as indicated in [Table 1](#).
6. Connect the associated output common (-V2) for OUT 16...31 to COM2 (terminals 44, 46, 48, or 50) on the 34...51 row (C).
7. If continuing power to the next terminal base, connect a jumper from terminal 35, 37, 39, or 41 (+V1) and 43, 45, 37, or 49 (+V2) on this base unit to the power terminal on the next base unit.
8. If continuing output common return to the next base unit, connect a jumper from terminal 36, 38, 40, or 42 (COM1) and 44, 46, 48, or 50 (COM2) on this base unit to common on the next base unit. See the installation instructions for the terminal base unit.

IMPORTANT Total current draw through terminal base connection is limited to 10 A. Separate power connections to each terminal base may be necessary.

Table 1 - Wiring Connections for 1794-OB32P
Used with 1794-TB32 or 1794-TB32S Terminal Base Unit

Output	Output Terminal	Common	Power
Output 0	A-0	Connect common to terminals 36, 38, 40, and 42	Connect power to terminals 35, 37, 39, and 41
Output 1	A-1		
Output 2	A-2		
Output 3	A-3		
Output 4	A-4		
Output 5	A-5		
Output 6	A-6		
Output 7	A-7		
Output 8	A-8		
Output 9	A-9		
Output 10	A-10		
Output 11	A-11		
Output 12	A-12		
Output 13	A-13		
Output 14	A-14		
Output 15	A-15		
Output 16	B-17	Connect common to terminals 44, 46, 48, and 50	Connect power to terminals 43, 45, 47, and 49
Output 17	B-18		
Output 18	B-19		
Output 19	B-20		
Output 20	B-21		
Output 21	B-22		
Output 22	B-23		
Output 23	B-24		
Output 24	B-25		
Output 25	B-26		
Output 26	B-27		
Output 27	B-28		
Output 28	B-29		
Output 29	B-30		
Output 30	B-31		
Output 31	B-32		
For Outputs 0...15, use +V1 and COM1			
+V1 DC power	Power terminals 35, 37, 39, and 41		
COM1 DC Return	Common terminals 36, 38, 40, and 42		
For Outputs 16...31, use +V2 and COM2			
+V2 DC power	Power terminals 43, 45, 47, and 49		
COM2 DC Return	Common terminals 44, 46, 48, and 50		

1794-TB32 and 1794-TB32S Terminal Base Wiring for 1794-OB32P

- +V1 = Terminals 35, 37, 39 and 41
- +V2 = Terminals 43, 45, 47 and 49
- COM1 = Terminals 36, 38, 40 and 42
- COM2 = Terminals 44, 46, 48 and 50
- NC = No connections (terminals 16, 33, 34 and 51)

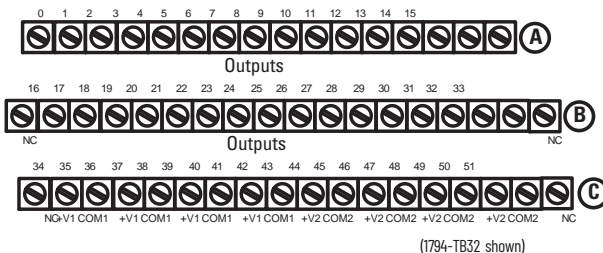

Configure the 1794-OB8EP Output Module

Configure your output module by setting bits in the configuration word.

Image Table Memory Map for the 1794-OB8EP Module

Dec	15	14	13	12	11	10	9	8	7	6	5	4	3	2	1	0	
Oct	17	16	15	14	13	12	11	10	7	6	5	4	3	2	1	0	
Read	F7	F6	F5	F4	F3	F2	F1	F0	Reserved ⁽¹⁾								
Write	Not used								FR	07	06	05	04	03	02	01	00

Where: 0 = Output – 00 corresponds to output 0, 01 corresponds to output 1, and so on.
 F = Overload fault bit – 1 = fault present; 0 = no fault
 FR = Fault reset bit – 1 = reset output; 0 = no change

(1) The unused lower byte in read word 1 floats during operation. Do not use this byte for fault status. See [Program the 1794-OB8EP](#).

Program the 1794-OB8EP

If your program automatically checks for fault bits, bits 8...15 of read word 1 must be masked. This is a sample program for a module at rack address 1, group 0. Add similar rungs to your program.

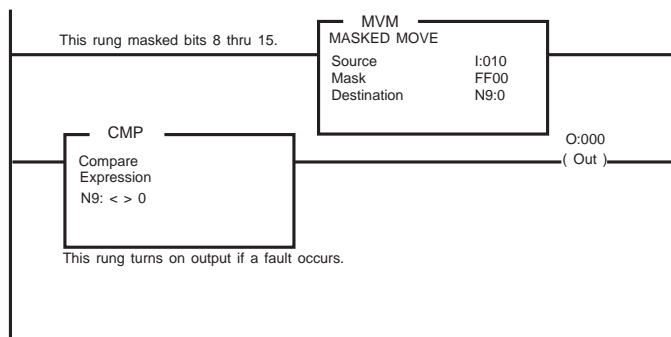

Reset a Fault on the 1794-OB8EP – Faults can be reset 3 ways: Press the fault reset button on the front of the module; or toggle the output reset bit (write word 1, bit 08); or cycle backplane power.

Use the Reset Button on the 1794-OB8EP – When you press the reset button, the fault indicator for the faulted output turns off for about 1.2 s. After the delay, the faulted output attempts to turn on. If the external condition causing the fault is corrected, the output will remain on, the fault indicator is off, and the status indicator is on.

Configure the 1794-0B8, 1794-0B16, 1794-0B16P, 1794-0B32P Modules

Configure your output module by setting bits in the configuration word (Word 3).

Image Table Memory Map - 1794-0B8, 1794-0B16, 1794-0B16P, and 1794-0B32P Modules

Dec	15	14	13	12	11	10	9	8	7	6	5	4	3	2	1	0
Oct	17	16	15	14	13	12	11	10	7	6	5	4	3	2	1	0
Read	Not used															
Write	015	014	013	012	011	010	09	08	07	06	05	04	03	02	01	00
Write 1794-0B32P only	031	030	029	028	027	026	025	024	023	022	021	020	019	018	017	016
Where:	0 = Output - 00 corresponds to output 0, 01 corresponds to output 1, and so on. 1794-0B8 uses outputs 0...7; 1794-0B16 and 1794-0B16P use outputs 0...15; 1794-0B32P uses outputs 0...31.															

Specifications

Specifications - 1794-0B8

Attribute	Value
Number of outputs	8, current, sourcing
Terminal base unit	1794-TB2, 1794-TB3, 1794-TB3S, 1794-TB3K, 1794-TB3SK
On-state voltage, output Min Nom Max	10V DC 24V DC 31.2V DC
Output current rating	4 A (8 outputs @ 0.5 A)
On-state current, output Min, per channel Max, per channel	1.0 mA 500 mA
On-state voltage drop, max	0.5V DC
Surge current, repeatable every 2 seconds	2 A for 50 ms
Off-state leakage current, max	0.5 mA
Isolation voltage	50V (continuous), Basic Insulation Type Tested at 850V DC for 1 s, between user and system No isolation between individual channels
Output signal delay Off to On On to Off	0.5 ms 1.0 ms
FlexBus current	60 mA @ 5V DC
Power dissipation, max	3.3 W @ 31.2V DC
Thermal dissipation, max	11.2 BTU/hr @ 31.2V DC
Fusing	Module outputs are not fused. Fusing is recommended. If fusing is desired, you must provide external fusing. Use SAN-O M04-800 mA fuses.

Specifications - 1794-0B8EP

Attribute	Value
Number of outputs	8, current, sourcing
Terminal base unit	1794-TB2, 1794-TB3, 1794-TB3S, 1794-TBN, 1794-TB3K, 1794-TB3SK, 1794-TBNK
On-state voltage, output Min Nom Max	19.2V DC 24V DC 31.2V DC
Output current rating, max per output	2.0 A
Output current rating, max per module	10.0 A (8 outputs @ 1.25 A, 5 outputs @ 2.0 A, or similar combinations totaling 10.0 A or less)
On-state current, output Min, per channel Max, per channel	1.0 mA 2.0 A
On-state voltage drop, max	0.2V DC
Surge current, repeatable every 3 seconds	4 A for 50 ms
Off-state leakage current, max	0.5 mA
Isolation voltage	50V (continuous), Basic Insulation Type Tested at 850V DC for 1 s, between field side and system No isolation between individual channels
Output signal delay Off to On On to Off	0.1 ms 0.1 ms

Specifications - 1794-OB8EP (Continued)

Attribute	Value
FlexBus current	73 mA @ 5V DC
Power dissipation, max	5.5 W @ 31.2V DC
Thermal dissipation, max	18.8 BTU/hr @ 31.2V DC
Fusing	Outputs are electronically fused

Figure 1 - Surge Current for 1794-OB8EP

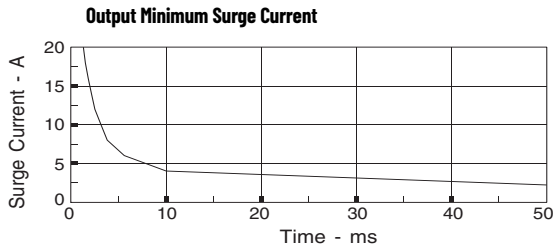

Specifications - 1794-OB16 and 1794-OB16P

Attribute	1794-OB16	1794-OB16P
Number of outputs	16, current, sourcing	
Terminal base unit	1794-TB2,1794-TB3,1794-TB3S, 1794-TB3K, 1794-TB3SK	
On-state voltage, output	10V DC 24V DC 31.2V DC (see Figure 2)	
Output current rating	8.0 A (16 outputs @ 0.5 A)	
On-state current, output	1.0 mA 500 mA	
On-state voltage drop, max	0.5V DC	
Surge current, repeatable every 2 seconds	2 A for 50 ms	1.5 A for 50 ms
Off-state leakage current, max	0.5 mA	
Isolation voltage	50V (continuous), Basic Insulation Type Tested at 850V DC for 1 s between user and system No isolation between individual channels	50V (continuous), Basic Insulation Type Type tested at 2121V DC for 60 s, between field side and system No isolation between individual channels
Output signal delay	0.5 ms 1.0 ms	
FlexBus current	80 mA @ 5V DC	60 mA @ 5V DC
Power dissipation, max	5.3 W @ 31.2V DC	5.0 W @ 31.2V DC
Thermal dissipation, max	18.1 BTU/hr @ 31.2V DC	17.0 BTU/hr @ 31.2V DC
Fusing	Module outputs are not fused. Fusing is recommended. If fusing is desired, you must provide external fusing. Use SAN-O MQ4-800mA fuses.	Outputs are electronically protected.

Specifications - 1794-OB32P

Attribute	Value
Number of outputs	32, current, sourcing
Terminal base unit	1794-TB32, 1794-TB32S
On-state voltage, output	10V DC 24V DC 31.2V DC
Output current rating	14.0 A max per module (6 A total for channels 0...15; 8 A total for channels 16...31)
On-state current, output	1.0 mA 500 mA
On-state voltage drop, max	0.5V DC
Surge current	2 A for 50 ms, repeatable every 2 seconds
Off-state leakage current, max	0.5 mA

Specifications - 1794-OB32P (Continued)

Attribute	Value
Isolation voltage	50V (continuous), Basic Insulation Type Type tested at 850V DC for 60 s, between field side and system No isolation between individual channels
Output signal delay Off to On On to Off	0.5 ms 1.0 ms
FlexBus current	80 mA @ 5V DC
Power dissipation, max	5.3 W @ 32.1V DC
Thermal dissipation, max	18.1 BTU/hr @ 31.2V DC
Fusing	Outputs are electronically protected.

General Specifications

Attribute	Value
Off-state voltage, max	31.2V DC
Terminal base screw torque	Determined by installed terminal base
Dimensions, approx. (H x W x D)	94 x 94 x 69 mm (3.7 x 3.7 x 2.7 in.)
Weight, approx.	73 g (2.57 oz.) - 1794-OB8 104 g (3.66 oz.) - 1794-OB8EP 78 g (2.75 oz.) - 1794-OB16 74 g (2.61 oz.) - 1794-OB16P 85 g (2.99 oz.) - 1794-OB32P
Indicators (field side indication)	8 yellow status indicators - 1794-OB8, 1794-OB8EP 8 red fault indicators - 1794-OB8EP 16 yellow status indicators - 1794-OB16, 1794-OB16P 32 yellow status indicators - 1794-OB32P
External DC power supply voltage, nom	24V DC
External DC power voltage range	(1794-OB8, 1794-OB16, 1794-OB16P, 1794-OB32P) 10...31.2V DC (includes 5% AC ripple) (1794-OB8EP) 19.2...31.2V DC (includes 5% AC ripple)
External DC power supply current	25 mA @ 24V DC (10...35 mA) - 1794-OB8 80 mA @ 24V DC - 1794-OB8EP 49 mA @ 24V DC (20...65 mA) - 1794-OB16 60 mA @ 24V DC (25...75 mA) - 1794-OB16P (see Figure 2) 219 mA @ 24V DC (104 mA @ 10V DC; 278 mA @ 31.2V DC) - 1794-OB32P
North American temp code	T4A - 1794-OB8, 1794-OB8EP, 1794-OB16 T3C - 1794-OB16P, 1794-OB32P
UKEX/ATEX temp code	T4 - 1794-OB8, 1794-OB8EP, 1794-OB16 T3 - 1794-OB16P
IECEx temp code	T4 - 1794-OB8EP T3 - 1794-OB16P
Keyswitch position	2
Enclosure type rating	None (open-style)
Wire size	Determined by installed terminal base
Wiring category ⁽¹⁾	2 - on signal ports

(1) Use this Conductor Category information for planning conductor routing. See the Industrial Automation Wiring and Grounding Guidelines, publication [1770-4.1](#).

Environmental Specifications

Attribute	Value
Temperature, operating	IEC 60068-2-1 (Test Ad, Operating Cold), IEC 60068-2-2 (Test Bd, Operating Dry Heat), IEC 60068-2-14 (Test Nb, Operating Thermal Shock): -20...+55 °C (-4...+131 °F) - 1794-OB8, 1794-OB8EP, 1794-OB16, 1794-OB16P 0...55 °C (32...131 °F) - 1794-OB32P
Temperature, surrounding air, max.	55 °C (131 °F)
Temperature, nonoperating	IEC 60068-2-1 (Test Ab, Unpackaged Nonoperating Cold), IEC 60068-2-2 (Test Bb, Unpackaged Nonoperating Dry Heat), IEC 60068-2-14 (Test Na, Unpackaged Nonoperating Thermal Shock): -40...+85 °C (-40...+185 °F)
Relative humidity	IEC 60068-2-30 (Test Db, Unpackaged Damp Heat): 5...95% non-condensing
Vibration	IEC60068-2-6 (Test Fc, Operating): 5 g @ 10...500 Hz

Environmental Specifications (Continued)

Attribute	Value
Shock	IEC60068-2-27 (Test Ea, Unpackaged shock): Operating 30 g Nonoperating 50 g
Emissions	CISPR 11: Group 1, Class A (with appropriate enclosure)
ESD immunity	IEC 61000-4-2: 6 kV contact discharges 8 kV air discharges
Radiated RF immunity	IEC 61000-4-3: 10V/m with 1 kHz sine-wave 80% AM from 80...6000 MHz
EFT/B immunity	IEC 61000-4-4: ±2 kV @ 5 kHz on power ports - 1794-0B8, 1794-0B16, 1794-0B32P ±3 kV @ 5 kHz on power ports - 1794-0B8EP, 1794-0B16P ±2 kV @ 5 kHz on signal ports - 1794-0B8, 1794-0B16, 1794-0B32P ±3 kV @ 5 kHz on signal ports - 1794-0B8EP, 1794-0B16P
Surge transient immunity	IEC 61000-4-5: ±1 kV line-line(DM) and ±2 kV line-earth(CM) on signal ports
Conducted RF immunity	IEC 61000-4-6: 10V rms with 1 kHz sine-wave 80% AM from 150 kHz...80 MHz

Certifications

Certifications (when product is marked) ⁽¹⁾	Value
c-UL-us	1794-0B8, 1794-0B8EP, 1794-0B16, 1794-0B16P only UL Listed Industrial Control Equipment, certified for US and Canada. See UL File E65584. UL Listed for Class I, Division 2 Group A,B,C,D Hazardous Locations, certified for U.S. and Canada. See UL File E194810. 1794-0B32P UL Listed Industrial Control Equipment, certified for US and Canada. See UL File E322657. UL Listed for Class I, Division 2 Group A,B,C,D Hazardous Locations, certified for U.S. and Canada. See UL File E334470.
UK and CE	UK Statutory Instrument 2016 No. 1091 and European Union 2014/30/EU EMC Directive, compliant with: EN 61326-1; Meas./Control/Lab., Industrial Requirements EN 61000-6-2; Industrial Immunity EN 61131-2; Programmable Controllers EN 61000-6-4; Industrial Emissions UK Statutory Instrument 2012 No. 3032 and European Union 2011/65/EU RoHS, compliant with: EN 63000; Technical documentation
Ex	For 1794-0B8EP, 1794-0B16P UK Statutory Instrument 2016 No. 1107 and European Union 2014/34/EU ATEX Directive, compliant with: EN IEC 60079-0; General Requirements EN IEC 60079-7; Explosive Atmospheres, Protection "e" II 3 G Ex ec IIC T4 Gc - 1794-0B8EP II 3 G Ex ec IIC T3 Gc - 1794-0B16P DEMKO 14 ATEX 1342501X UL22UKEX2378X For 1794-0B8, 0B16 European Union 2014/34/EU ATEX Directive, compliant with: EN 60079-0; General Requirements EN 60079-15; Potentially Explosive Atmospheres, Protection "n" II 3 G Ex nA IIC T4 Gc LCIE 01ATEX6020X
IECEX	For 1794-0B8EP, 1794-0B16P IECEX System, compliant with: IEC 60079-0; General Requirements IEC 60079-7; Explosive Atmospheres, Protection "e" Ex ec IIC T4 Gc Ex ec IIC T3 Gc IECEX UL 14.0066X
CCC	For 1794-0B8, 1794-0B8EP, 1794-0B16, 1794-0B16P CNCA-C23-01 强制性产品认证实施规则 防爆电气 CNCA-C23-01 CCC Implementation Rule Explosion-Proof Electrical Products
Morocco	Arrêté ministériel n° 6404-15 du 29 ramadan 1436
TÜV	1794-0B8EP, 1794-0B16, 1794-0B16P only TÜV Certified for Functional Safety: up to and including SIL 2
KC	Korean Registration of Broadcasting and Communications Equipment, compliant with: Article 58-2 of Radio Waves Act, Clause 3
EAC	Russian Customs Union TR CU 020/2011 EMC Technical Regulation
RCM	Australian Radiocommunications Act, compliant with: EN 61000-6-4; Industrial Emissions

(1) See the Product Certification link at rok.auto/certifications for Declarations of Conformity, Certificates, and other certification details.

Figure 2 - Derating Curve for 1794-OB16P

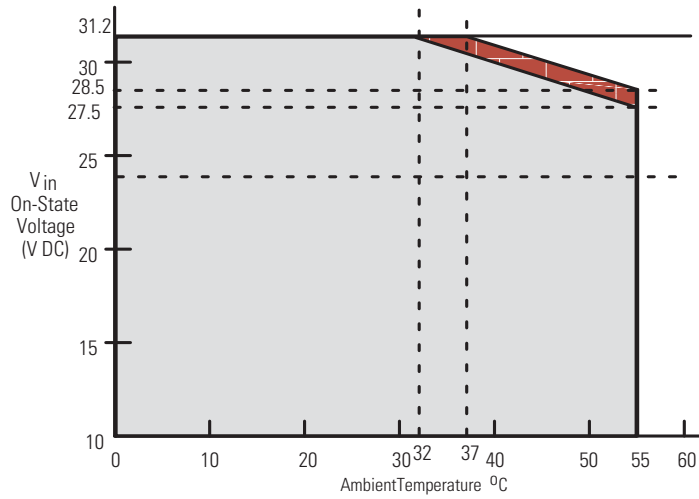

The area within the curve represents the safe operating range for the module under various conditions of user supplied 24V DC supply voltages and ambient temperatures.

- = Normal mounting safe operating range, (includes).
- = Other mounting positions (including inverted horizontal) safe operating

Normal Mounting – Horizontal

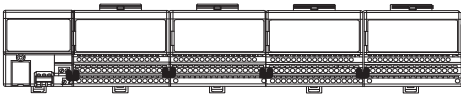

Other Mounting (including Vertical, and Inverted Horizontal Mounting)

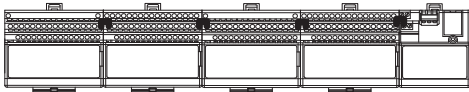

Rockwell Automation Support

Use these resources to access support information.

Technical Support Center	Find help with how-to videos, FAQs, chat, user forums, and product notification updates.	rok.auto/support
Knowledgebase	Access Knowledgebase articles.	rok.auto/knowledgebase
Local Technical Support Phone Numbers	Locate the telephone number for your country.	rok.auto/phonesupport
Literature Library	Find installation instructions, manuals, brochures, and technical data publications.	rok.auto/literature
Product Compatibility and Download Center (PCDC)	Download firmware, associated files (such as AOP, EDS, and DTM), and access product release notes.	rok.auto/pcdc

Documentation Feedback

Your comments help us serve your documentation needs better. If you have any suggestions on how to improve our content, complete the form at rok.auto/docfeedback.





Waste Electrical and Electronic Equipment (WEEE)



At the end of life, this equipment should be collected separately from any unsorted municipal waste.

Rockwell Automation maintains current product environmental compliance information on its website at rok.auto/pec.

Rockwell Otomasyon Ticaret A.Ş. Kar Plaza İş Merkezi E Blok Kat:6 34752 İçerenköy, İstanbul, Tel: +90 (216) 5698400 EEE Yönetmeliğine Uygundur

Connect with us.    

rockwellautomation.com — expanding **human possibility**[®]

AMERICAS: Rockwell Automation, 1201 South Second Street, Milwaukee, WI 53204-2496 USA, Tel: (1) 414.382.2000, Fax: (1) 414.382.4444

EUROPE/MIDDLE EAST/AFRICA: Rockwell Automation NV, Pegasus Park, De Kleetlaan 12a, 1831 Diegem, Belgium, Tel: (32) 2 663 0600, Fax: (32) 2 663 0640

ASIA PACIFIC: Rockwell Automation, Level 14, Core F, Cyberport 3, 100 Cyberport Road, Hong Kong, Tel: (852) 2887 4788, Fax: (852) 2508 1846

Allen-Bradley, expanding human possibility, FactoryTalk, FLEX I/O, Rockwell Automation, and TechConnect are trademarks of Rockwell Automation, Inc. Trademarks not belonging to Rockwell Automation are property of their respective companies.

Publication 1794-IN094E-EN-P - July 2022 | Supersedes Publication 1794-IN094D-EN-P - July 2018
Copyright © 2022 Rockwell Automation, Inc. All rights reserved.