



USB-to-DeviceNet Cable

Catalog Number 1784-U2DN

Topic	Page
Important User Information	2
Environment and Enclosure	3
About the Cable	4
Install the Cable	5
Status Indicators	10
Additional Resources	15

Important User Information

Solid-state equipment has operational characteristics differing from those of electromechanical equipment. Safety Guidelines for the Application, Installation and Maintenance of Solid State Controls (Publication SGI-1.1 available from your local Rockwell Automation sales office or online at <http://www.rockwellautomation.com/literature/>) describes some important differences between solid-state equipment and hard-wired electromechanical devices. Because of this difference, and also because of the wide variety of uses for solid-state equipment, all persons responsible for applying this equipment must satisfy themselves that each intended application of this equipment is acceptable.





In no event will Rockwell Automation, Inc. be responsible or liable for indirect or consequential damages resulting from the use or application of this equipment.

The examples and diagrams in this manual are included solely for illustrative purposes. Because of the many variables and requirements associated with any particular installation, Rockwell Automation, Inc. cannot assume responsibility or liability for actual use based on the examples and diagrams.

No patent liability is assumed by Rockwell Automation, Inc. with respect to use of information, circuits, equipment, or software described in this manual.

Reproduction of the contents of this manual, in whole or in part, without written permission of Rockwell Automation, Inc., is prohibited.

Throughout this manual, when necessary, we use notes to make you aware of safety considerations.

	WARNING: Identifies information about practices or circumstances that can cause an explosion in a hazardous environment, which may lead to personal injury or death, property damage, or economic loss.
	ATTENTION: Identifies information about practices or circumstances that can lead to personal injury or death, property damage, or economic loss. Attentions help you identify a hazard, avoid a hazard and recognize the consequences.
	SHOCK HAZARD: Labels may be on or inside the equipment, for example, drive or motor, to alert people that dangerous voltage may be present.
	BURN HAZARD: Labels may be on or inside the equipment, for example, drive or motor, to alert people that surfaces may reach dangerous temperatures.
IMPORTANT	Identifies information that is critical for successful application and understanding of the product.

Environment and Enclosure



ATTENTION: This equipment is intended for use in overvoltage Category II applications (as defined in IEC 60664-1), at altitudes up to 2000 m (6562 ft) without derating.

This equipment is considered Group 1, Class A industrial equipment according to IEC/CISPR 11. Without appropriate precautions, there may be potential difficulties with electromagnetic compatibility in residential and other environments due to conducted and radiated disturbances.

This equipment is supplied as enclosed equipment. It should not require additional system enclosure when used in locations consistent with the enclosure type ratings stated in the Specifications section of this publication. Subsequent sections of this publication may contain additional information regarding specific enclosure type ratings, beyond what this product provides, that are required to comply with certain product safety certifications.

In addition to this publication, see the following:

- Industrial Automation Wiring and Grounding Guidelines, , publication [1770-4.1](#), for additional installation requirements
- NEMA Standard 250 and IEC 60529, as applicable, for explanations of the degrees of protection provided by enclosures



At the end of its life, this equipment should be collected separately from any unsorted municipal waste.

About the Cable

The 1784-U2DN USB-to-DeviceNet cable lets you connect a computer to a DeviceNet network via an unused USB port on the computer.

IMPORTANT To comply with the CE low voltage directive (LVD), this equipment must be powered from a source compliant with safety extra low voltage (SELV) or protected extra low voltage (PELV).

The 1784-U2DN cable replaces the 1784-PCD communication card.

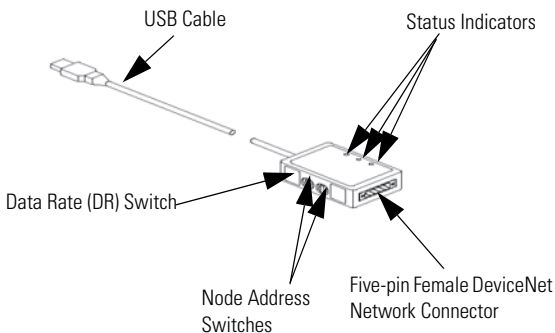

The cable operates at data rates of 125 Kbps, 250 Kbps, and 500 Kbps.

IMPORTANT The data rate is read only when power is applied. To change the data rate, you must disconnect the cable from the USB port, use the data rate switch to change the data rate setting, then reconnect the cable to the USB port.

These are the firmware variations:

- Cables with version 1.009 or later contain a fix for an anomaly whereby timeouts could be experienced while monitoring parameters of some devices. The initial installation of a 1784-U2DN USB-to-DeviceNet cable will no longer cause the Windows operating system to report an error code 10.
- Cables with version 1.008 or later have an explicit message size of 500 bytes, which allows uploading from a SmartGuard controller.

Install the Cable

Follow these procedures to install the cable.



ATTENTION: Prevent Electrostatic Discharge

This equipment is sensitive to electrostatic discharge, which can cause internal damage and affect normal operation. Follow these guidelines when you handle this equipment:

- Touch a grounded object to discharge potential static.
- Wear an approved grounding wriststrap.
- Do not touch connectors or pins on component boards.
- Do not touch circuit components inside the equipment.
- Use a static-safe workstation, if available.
- Store the equipment in appropriate static-safe packaging when not in use.



ATTENTION: USB connection length must be less than 3 m (9.84 ft). Do not attempt to extend the cable.

Obtain the Device Driver for the Cable

Follow these steps to download and install the device driver for the cable.

IMPORTANT A minimum of RSLinx Classic software, version 2.51, is required for use with the cable.

IMPORTANT If RSLinx Classic software, version 2.54 or later, is installed on the computer, the device driver is already installed on the computer. Skip this section.

1. Visit <http://www.rockwellautomation.com/knowledgebase/>.
2. Open tech note ID 53280 and follow the instructions to install the driver.

Configure and Connect the Cable

1. Use the data rate (DR) switch on the side of the connector to set the network data rate to 125 Kbps or Auto.

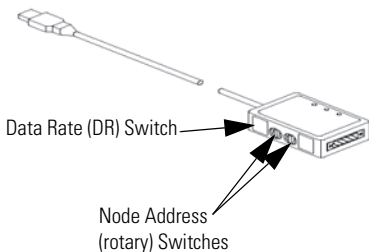

2. Use the rotary switches to set the module node address to a valid number (0...63).
3. Insert the end of the cable with the USB connector into a USB port on a computer.

4. Insert a DeviceNet network cable into the five-pin female DeviceNet network connector.

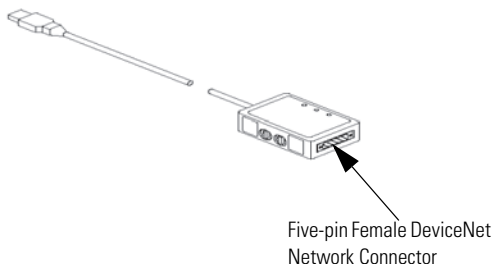
**TIP**

A 10-pin plug-in connector (catalog number 1787-PLUG10R, PN-94220605) is shipped with the 1784-U2DN cable. See the figure and chart for wiring.

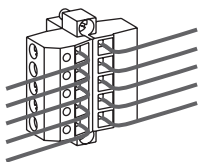

Connect	To
Red wire	V+
White wire	CAN High
Bare wire	Shield
Blue wire	CAN Low
Black wire	V-

Change the Data Rate

The 1784-U2DN cable can automatically detect the data rate being used on an active DeviceNet network. To use this feature, set the data rate (DR) switch to Auto. If the cable does not detect any network traffic for a period of 12 seconds after it is plugged into the USB port, it will set itself to a fallback data rate. The factory-default fallback data rate is 125 Kbps.

You can change the fallback data rate either manually or with RSNetWorx for DeviceNet software.

TIP Manually selecting 125 Kbps and using the fallback data rate lets the cable communicate with devices on a network that does not have active traffic (for example, a network consisting of slaves and no master) for node commissioning.

Manually Set the Data Rate

1. Unplug the cable from the USB port.
2. Set the rotary address switches to 90 for 125 Kbps, 91 for 250 Kbps, or 92 for 500 Kbps.
3. Plug the cable into the USB port and wait for the cable to finish powering up.
4. Unplug the cable from the USB port.
5. Set the rotary address switches to a valid address (0...63).
6. Plug the cable into the USB port.

Use RSNetWorx for DeviceNet Software to Set the Speed

IMPORTANT The fallback rate can be set only with the software when the link speed switch is in the Auto position.

TIP You cannot change the node address with software. You can set the node address only by using the rotary switches on the module.

1. Start RSNetWorx for DeviceNet software.
2. From the Tools menu, choose Node Commissioning.
3. Click Browse and navigate to the 1784-U2DN cable to be modified.
4. Change the data rate and click Apply.

Product Dimensions

The following illustration shows the product dimensions.

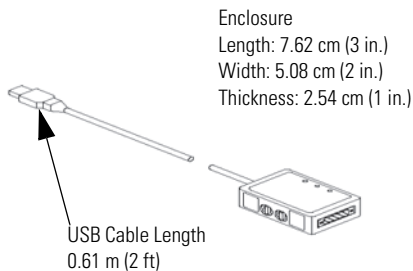

Status Indicators

The following table describes the cable status indicators.

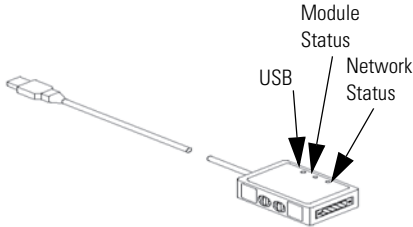

Status Indicators

Indicator	Status	Description
USB	Green	The cable is configured, but no network traffic is present.
	Flashing green	Network traffic is present.
	Off	Unable to transfer data: <ul style="list-style-type: none"> • Disconnected from host. • In one of the following states: <ul style="list-style-type: none"> – Default – Powered – Address – Suspend

Status Indicators

Indicator	Status	Description
Module Status (MS)	Green	The cable is operating normally.
	Off	No power to the cable.
	Flashing green	The cable is operating in a normal condition and is online with no connections established: <ul style="list-style-type: none"> • The cable may be in Standby mode. • The cable needs commissioning due to missing, incomplete, or incorrect configuration.
	Flashing red	The cable has a recoverable fault.
	Red	The cable has an unrecoverable fault and may need to be replaced.
	Flashing red/green	The cable is performing a self-test.
Network Status (NS)	Off	<ul style="list-style-type: none"> • The cable has not yet completed the Dup_MAC_ID test. • The cable may not be powered (if the Module Status indicator is off). • No network power present.
	Flashing green	The cable is online, and has passed the Dup_MAC_ID test, but has no established connections to the other nodes.
	Green	The cable is online and has established connections to the other nodes.
	Red	The cable has detected a communication error, such as a duplicate MAC ID or bus-off condition.

Traffic Analyzer Software

The 1784-U2DN cable is designed to work with Frontline's NetDecoder traffic analyzer software. For more information on Frontline's product, go to either <http://www.rockwellautomation.com/encompass/> or <http://www.fte.com>.

Specifications

Technical Specifications - 1784-U2DN

Attribute	1784-U2DN
Enclosure type rating	Meets IP30
USB Supply	75 mA @ 5V DC
DeviceNet Supply	70 mA @ 24V DC
Power consumption	0.5 W
Power dissipation	0.5 W
Isolation voltage	30V (continuous), basic insulation type Type tested at 500V AC for 60 s, DeviceNet network to USB
Weight, approx.	0.11 kg (0.23 lb)
Wire size	DeviceNet network: 0.05...3.3 mm ² (30...12 AWG) solid or stranded copper wire rated at 75 °C (167 °F) or greater 1.2 mm (3/64 in.) insulation max
Wiring category ⁽¹⁾	2 - on communication ports
Terminal block torque	DeviceNet network: 0.6...0.8 N•m (5.0...7.0 lb•in)

- (1) Use this Conductor Category information for planning conductor routing. Refer to Industrial Automation Wiring and Grounding Guidelines, publication [1770-4.1](#).

Environmental Specifications - 1784-U2DN

Attribute	1784-U2DN
Temperature, operating <ul style="list-style-type: none"> • IEC 60068-2-1 (Test Ad, Operating Cold) • IEC 60068-2-2 (Test Bd, Operating Dry Heat) • IEC 60068-2-14 (Test Nb, Operating Thermal Shock) 	0...55 °C (32...131 °F)
Temperature, nonoperating <ul style="list-style-type: none"> • IEC 60068-2-1 (Test Ab, Unpackaged Nonoperating Cold) • IEC 60068-2-2 (Test Bb, Unpackaged Nonoperating Dry Heat) • IEC 60068-2-14 (Test Na, Unpackaged Nonoperating Thermal Shock) 	-10...85 °C (14...185 °F)
Relative humidity IEC 60068-2-30 (Test Db, Unpackaged Damp Heat)	5...95% noncondensing
Shock, nonoperating IEC 60068-2-27 (Test Ea, Unpackaged Shock)	1000 mm (3.28 ft)
Emissions CISPR 11	Group 1, Class A
ESD immunity IEC 61000-4-2	8 kV air discharges
Radiated RF immunity IEC 61000-4-3	<ul style="list-style-type: none"> • 10V/m with 1 kHz sine-wave 80%AM from 80...2000 MHz • 10V/m with 200 Hz 50% Pulse 100%AM at 900 MHz • 10V/m with 200 Hz 50% Pulse 100%AM at 1890 MHz • 3V/m with 1 kHz sine-wave 80%AM from 2000...2700 MHz
EFT/B immunity IEC 61000-4-4	±2 kV at 5 kHz on DeviceNet port
Surge transient immunity IEC 61000-4-5	±2 kV line-earth (CM) on DeviceNet port
Conducted RF immunity IEC 61000-4-6	10V rms with 1 kHz sine-wave 80% AM from 150 kHz...80 MHz on DeviceNet port

Certifications - 1784-U2DN

Certification⁽¹⁾ (when product is marked)	1784-U2DN
c-UL-us	UL Listed Industrial Control Equipment, certified for US and Canada. See UL File E65584.
CE	European Union 2004/108/EC EMC Directive, compliant with: <ul style="list-style-type: none"> • EN 61326-1; Meas./Control/Lab., Industrial Requirements • EN6100-6-2; Industrial Immunity • EN 61000-6-4; Industrial Emissions • EN 61131-2; Programmable Controllers (Clause 8, Zone A & B)
C-Tick	Australian Radiocommunications Act, compliant with: <ul style="list-style-type: none"> • AS/NZS CISPR 11; Industrial Emissions
ODVA	ODVA conformance tested to DeviceNet specifications

(1) See the Product Certification link at <http://www.ab.com> for Declarations of Conformity, Certificates, and other certification details.

Additional Resources

These documents contain additional information concerning related products from Rockwell Automation.

Resource	Description
DeviceNet Media Design and Installation Guide, publication DNET-UM072	Provides DeviceNet network planning information.
Industrial Automation Wiring and Grounding Guidelines, publication 1770-4.1	Provides general guidelines for installing a Rockwell Automation industrial system.
Product Certifications website, http://www.ab.com	Provides declarations of conformity, certificates, and other certification details.

You can view or download publications at <http://www.rockwellautomation.com/literature/>. To order paper copies of technical documentation, contact your local Allen-Bradley distributor or Rockwell Automation sales representative.

Rockwell Automation Support

Rockwell Automation provides technical information on the Web to assist you in using its products. At <http://www.rockwellautomation.com/support/>, you can find technical manuals, a knowledge base of FAQs, technical and application notes, sample code and links to software service packs, and a MySupport feature that you can customize to make the best use of these tools.

For an additional level of technical phone support for installation, configuration, and troubleshooting, we offer TechConnect support programs. For more information, contact your local distributor or Rockwell Automation representative, or visit <http://www.rockwellautomation.com/support/>.

Installation Assistance

If you experience a problem within the first 24 hours of installation, please review the information that's contained in this manual. You can also contact a special Customer Support number for initial help in getting your product up and running.

United States or Canada	1.440.646.3434
Outside United States or Canada	Use the Worldwide Locator at http://www.rockwellautomation.com/support/americas/phone_en.html , or contact your local Rockwell Automation representative.

New Product Satisfaction Return

Rockwell Automation tests all of its products to ensure that they are fully operational when shipped from the manufacturing facility. However, if your product is not functioning and needs to be returned, follow these procedures.

United States	Contact your distributor. You must provide a Customer Support case number (call the phone number above to obtain one) to your distributor to complete the return process.
Outside United States	Please contact your local Rockwell Automation representative for the return procedure.

Documentation Feedback

Your comments will help us serve your documentation needs better. If you have any suggestions on how to improve this document, complete this form, publication [RA-DU002](#), available at <http://www.rockwellautomation.com/literature/>.

Allen-Bradley, Rockwell Software, Rockwell Automation, SmartGuard, RSLinx Classic, RSNetWorx for DeviceNet, Encompass, and TechConnect are trademarks of Rockwell Automation, Inc.

Trademarks not belonging to Rockwell Automation are property of their respective companies.

Rockwell Otomasyon Ticaret A.Ş., Kar Plaza İş Merkezi E Blok Kat:6 34752 İçerenköy, İstanbul, Tel: +90 (216) 5698400

www.rockwellautomation.com

Power, Control and Information Solutions Headquarters

Americas: Rockwell Automation, 1201 South Second Street, Milwaukee, WI 53204-2496 USA, Tel: (1) 414.382.2000, Fax: (1) 414.382.4444
Europe/Middle East/Africa: Rockwell Automation NV, Pegasus Park, De Kleerlaan 12a, 1831 Diegem, Belgium, Tel: (32) 2 663 0600, Fax: (32) 2 663 0640
Asia Pacific: Rockwell Automation, Level 14, Core F, Cyberport 3, 100 Cyberport Road, Hong Kong, Tel: (852) 2887 4788, Fax: (852) 2508 1846

Publication 1784-IN046D-EN-P - May 2011

PN-111579

Supersedes Publication 1784-IN046C-EN-P - July 2009

Copyright © 2011 Rockwell Automation, Inc. All rights reserved. Printed in the U.S.A.