



Ethernet Media Specifications

Bulletin Number 1585

Topic	Page
Summary of Changes	2
Introduction	2
Cable Spools	3
Shielded Twisted-pair (Foil and Braided Shield)	4
600V Ethernet Cable	5
RJ45 Cordsets and Patchcords	7
RJ45 Gigabit Cordset, Cat 6	9
RJ45 Red Cordset	10
M12 Flex-rated	11
M12 Receptacle Flex-rated	13
M12 Xcode Flex-rated Gigabit	15
M12 Red	16
RJ45 Field Attachable Connector	17
M12 Insulation Displacement Connectors (IDC)	19
M12 to RJ45 Bulkhead Connector	21
Additional Resources	21

Summary of Changes

This publication contains the following new or updated information. This list includes substantive updates only and is not intended to reflect all changes.

Topic	Page
Updated pinout drawings.	6, 7, 10, 13, 14, 16, and 18
Updated/added material specifications.	5, 7, 9, and 10

Introduction

As Ethernet is increasingly used in industrial control, survival of physical media in rugged or harsh environments is becoming a necessity. The high speed of network protocol allows it to be used in applications where other networks fall short. EtherNet/IP™ uses both standard Ethernet and TCP/IP technologies and an open application layer protocol that is called the Control and Information Protocol (CIP). This application layer is the same as used in DeviceNet® and ControlNet® networks.

Rockwell Automation® Cat 5e Ethernet cables are designed to supply a network connection with excellent reliability in harsh surroundings. By optimizing the balance of twisted-pair conductors inside a robust Thermoplastic Elastomer (TPE) jacket, data is protected from noise, chemicals, and mechanical issues to M₃I₃C₃E₃ environmental protection levels. The cable is available in RJ45 patchcords for IP20 applications or in four-pin D-coded M12 patchcords for IP67 applications where high vibration, fluids, and other contaminants can threaten the reliability of a network.

M12 D-code field attachable insulation displacement connectors (IDC) are available in both shielded and unshielded housings with male or female connectors. Male eight-pin RJ45 connectors are available in both a crimp termination and a toolless IDC connector for custom cabling.

Rockwell Automation M12 to RJ45 bulkhead connectors provide an elegant transition for network architecture from an IP20 setting to an IP67 environment. The adapter can be used to connect remote junction boxes or implement an On-Machine™ solution with Armor™ I/O products.

The Rockwell Automation Ethernet media portfolio provides connectivity with excellent reliability to maintain network integrity and reduces costly downtime from troubleshooting.

Cable Spools



Unshielded Twisted-pair Ethernet Cable Spool

Features

- 4- and 8-conductor styles
- Unshielded cable types, Cat 5e
- 24 AWG conductors
- Twisted pairs maintain signal balance through cable to provide high noise immunity and return loss
- Designed to ODVA EtherNet/IP specifications and ISO IEC 24702
- Suitable for high noise environments $M_3I_3C_3E_3$
- Riser PVC cables are used for general-purpose environments
- TPE robotic cable is used for flex applications, transmission-tested to 10 million cycles
- Plenum PVC cable is used for air duct applications
- TPE cable meets channel transmission performance to 10 million flexes

Specifications

Attributes	Bulletin 1585
Certifications	UL Listed and CEC
Cable type	Unshielded: 2- and 4-pair, Cat 5e
Material	Conductor: Tinned copper stranded
Bend radius	10 million cycles at 20 x diameter (TPE cable)
Data rate	Up to 1 GB/s
Operating temperature	-40...+75 °C (-40...+167 °F)
Voltage	300V

Cable and Color Code

Two-pair	Four-pair																								
<table border="1"> <tbody> <tr> <td>White/Orange</td> <td></td> </tr> <tr> <td>White/Green</td> <td></td> </tr> <tr> <td>Orange</td> <td></td> </tr> <tr> <td>Green</td> <td></td> </tr> </tbody> </table>	White/Orange		White/Green		Orange		Green		<table border="1"> <tbody> <tr> <td>White/Orange</td> <td></td> </tr> <tr> <td>Orange</td> <td></td> </tr> <tr> <td>White/Green</td> <td></td> </tr> <tr> <td>Blue</td> <td></td> </tr> <tr> <td>White/Blue</td> <td></td> </tr> <tr> <td>Green</td> <td></td> </tr> <tr> <td>White/Brown</td> <td></td> </tr> <tr> <td>Brown</td> <td></td> </tr> </tbody> </table>	White/Orange		Orange		White/Green		Blue		White/Blue		Green		White/Brown		Brown	
White/Orange																									
White/Green																									
Orange																									
Green																									
White/Orange																									
Orange																									
White/Green																									
Blue																									
White/Blue																									
Green																									
White/Brown																									
Brown																									

Product Selection

Jacket Material	Cable Type	No. of Conductors	Jacket Color	Wire Size [AWG]	Nominal Outer Diameter	Operating Temperature	Cable Rating	Cat. No. (1)
Robotic TPE	Unshielded	4 (two pairs)	Teal	24	5.6 mm (0.22 in.)	-40...+75 °C (-40...+167 °F)	Weld splatter, sunlight, and oil-resistant; UL CM, CMX; cUL CM; Standard TIA 568-B, high flex rated	1585-C4TB-Sx
Plenum		8 (four pairs)	Red		5.84 mm (0.23 in.)			1585-C8TB-Sx
Riser PVC			Teal					1585-C8VB-Sx
							UL CMP; cUL CMG; Standard TIA 568-B	1585-C8MB-Sx
							UL CMR; cUL CMG; Standard TIA 568-B	1585-C8PB-Sx

(1) Replace x with 100 [100 m (328 ft)], 300 [300 m (984 ft)], or 600 [600 m (1969 ft)] for standard cable lengths (example 1585-C4TB-Sx becomes 1585-C4TB-S600 for a 600 m cable).

Shielded Twisted-pair (Foil and Braided Shield)



Shielded Ethernet Cable Spool

Specifications

Attributes	Bulletin 1585
Certifications	UL Listed and CEC
Material	<ul style="list-style-type: none"> Conductor: Tinned copper stranded Insulation: High-density polyethylene
Bend radius	10 million cycles at 20 x diameter (TPE cable)
Data rate	Up to 1 GB/s, Cat 5e
Voltage	300V

Features

- Four- and eight-conductor styles
- Twisted-pair shielded cable types, Cat 5e
- Twisted pairs maintain signal balance through cable to provide high noise immunity and return loss
- Designed to ODVA EtherNet/IP specifications and ISO IEC 24702
- Suitable for high noise environments $M_3I_3C_3E_3$
- Riser PVC cables used for general-purpose environments
- PUR robotic cable used for flex applications, also Halogen-free
- 600V PVC cable designed to support high-voltage applications
- 600V On-Machine rated cable for use in a cable tray that is shared with high-voltage power cables

Cable and Color Code

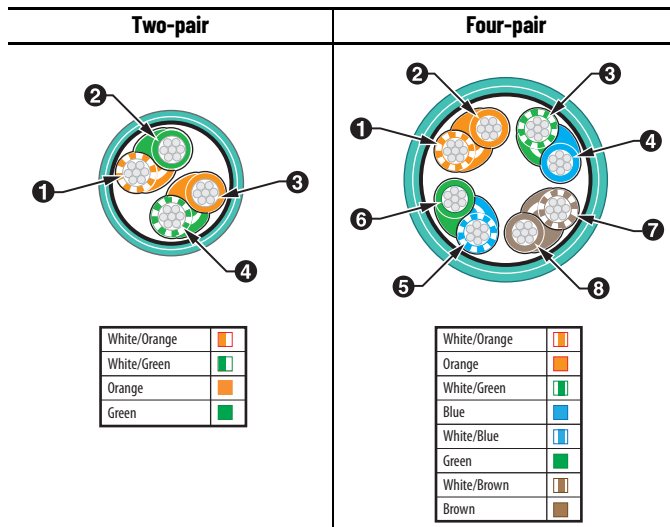

Product Selection

Jacket Material	Cable Type	No. of Conductors	Jacket Color	Wire Size [AWG]	Nominal Outer Diameter	Operating Temperature	Cable Rating	Cat. No. ⁽¹⁾
Riser PVC	Foil and braided shield	8 (four pairs)	Teal	26	5.84 mm (0.23 in.)	-40...+75 °C (-40...+167 °F)	UL CMR; cUL CMG; TIA-568-B	1585-C8CB-Sx
Robotic PUR		4 (two pairs)			—		C(ETL)US TYPE CMX; TIA 568-B, Flex rated, Halogen-Free	1585-C4UB-Sx
		8 (four pairs)			6.2 ± 12 mm (0.244 in.)			1585-C8UB-Sx
600V PVC	Foil shield	8 (four pairs)	Red	22	8.13 ± 0.38 mm (0.32 in.)	-20...+80 °C (-4...+176 °F)	(UL) CMX, CMR; c(UL) CMG; (UL) PLTC or AWM 2570 80 °C 600V; TIA-568-B	1585-C8HB-Sx
		4 (two pairs)	Teal					1585-C8EB-Sx
		4 (two pairs)	Red					1585-C4HB-Sx
								1585-C4EB-Sx

(1) Replace x with 100 [100 m (328 ft)], 300 [300 m (984 ft)], or 600 [600 m (1969 ft)] for standard cable lengths (example 1585-C8UB-Sx becomes 1585-C8UB-S600 for a 600 m cable).

600V Ethernet Cable

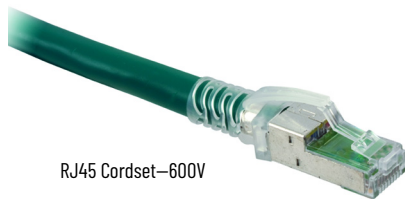

RJ45 Cordset—600V

Specifications

Attributes	Bulletin 1585
Certifications	UL and c-UL Listed
Material	<ul style="list-style-type: none"> Conductor: Thin copper stranded Insulation: Perfluoroalkoxy copolymer and polyolefin Contact: Gold-plated brass
Diameter	8.13 ± 0.38 mm (0.32 ± 0.015 in.)
Cable rating	UL, c-UL TYPE CMG; UL PLTC or UL AWM 2570 80°C 600V, TIA 568B

Cable Spool Product Selection

Jacket Material	Cable Type	No. of Conductors	Jacket Color	Wire Size [AWG]	Nominal Outer Diameter	Operating Temperature	Cable Rating	Cat. No. (1)
600V PVC	Foil shield	8 (four pairs)	Teal	22	8.13 ± 0.38 mm (0.32 in.)	-20...+80 °C (-4...+176 °F)	(UL) CMX, CMR; c(UL) CMG; (UL) PLTC or AWM 2570 80 °C 600V; TIA-568-B	1585-C8HB-Sx
			Red					1585-C8EB-Sx
		4 (two pairs)	Teal					1585-C4HB-Sx
			Red					1585-C4EB-Sx

(1) Replace x with 100 [100 m (328 ft)], 300 [300 m (984 ft)], or 600 [600 m (1969 ft)] for standard cable lengths (example 1585-C4HB-Sx becomes 1585-C4HB-S600 for a 600 m cable).

RJ45 Cordsets

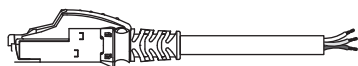

Shielding	Cable Type	Cat. No. (1)
Foil shield	8 conductor, teal 600V PVC	1585J-M8HB-x
	8 conductor, red 600V PVC	1585J-M8EB-x
	4 conductor, teal, 600V PVC	1585J-M4HB-x
	4 conductor, red, 600V PVC	1585J-M4EB-x

(1) Replace x with 2 [2 m (6.6 ft)], 5 [5 m (16.4 ft)], or 10 [10 m (32.8 ft)] for standard cable lengths (example 1585J-M8EB-x becomes 1585J-M8EB-10 for a 10 m cable).

RJ45 Patchcords

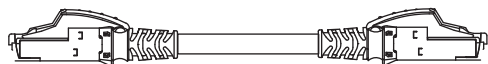

No. of Conductors	Jacket Material	Cable Type	Cable Rating	Cat. No. (1)
8	Teal 600V, PVC	Foil shield	(UL) CMX, CMR; c(UL) CMG; (UL) PLTC or AWM 2570 80 °C 600V; TIA-568-B	1585J-M8HBJM-x
	Red 600V PVC			1585J-M8EBJM-x
4	Teal 600V, PVC			1585J-M4HBJM-x
	Red 600V PVC			1585J-M4EBJM-x

(1) Replace x with 2 [2 m (6.6 ft)], 5 [5 m (16.4 ft)], or 10 [10 m (32.8 ft)] for standard cable lengths (example 1585J-M4HBJM-x becomes 1585J-M4HBJM-10 for a 10 m cable).

RJ45 Patchcords

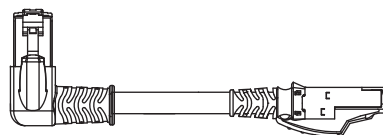

No. of Conductors	Jacket Material	Cable Type	Cable Rating	Angle	Cat. No. (1)
8	Teal 600V PVC	Foil shield	(UL) CMX, CMR; c(UL) CMG; (UL) PLTC or AWM 2570 80 °C 600V; TIA-568-B	Right	1585J-E8HBJM-x
4					1585J-E4HBJM-x
8				Left	1585J-L8HBJM-x
4					1585J-L4HBJM-x

(1) Replace x with 2 [2 m (6.6 ft)], 5 [5 m (16.4 ft)], or 10 [10 m (32.8 ft)] for standard cable lengths (example 1585J-E4HBJM-x becomes 1585J-E4HBJM-5 for a 5 m cable).

RJ45 IDC Connector

Insulation Diameter [mm (in.)]	Cable Diameter [mm (in.)]	Cat. No.
0.85...1.6 (0.033...0.063)	5...9 (0.197...0.354)	1585J-M8CC-H

Cable and Color Code

Four-pair

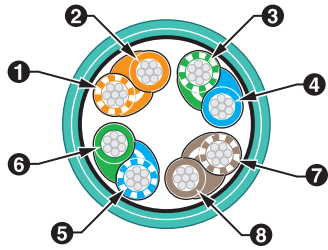

White/Orange	
Orange	
White/Green	
Blue	
White/Blue	
Green	
White/Brown	
Brown	

Color Code

Color Code	Face View RJ45 Pinout	
	8-pin	
A	1 White/Orange 2 Orange 3 White/Green 4 Blue 5 White/Blue 6 Green 7 White/Brown 8 Brown	TxData + TxData - Recv Data + Unused Unused Recv Data - Unused Unused

Approximate Dimensions

Dimensions are shown in mm (in.). Dimensions are not intended to be used for installation purposes.

RJ45 IDC Connector

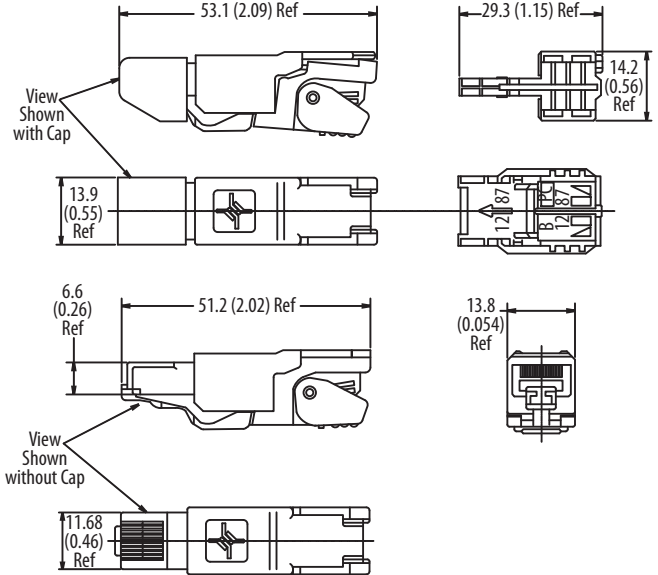

RJ45 90° Left and Right Angle Patchcord

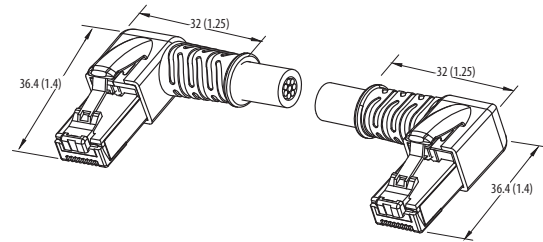

RJ45 Cordset and Patchcord

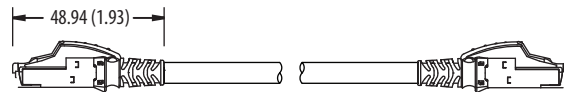

RJ45 Cordsets and Patchcords

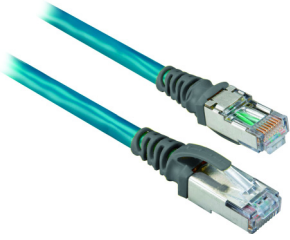

Features

- Flex-rated TPE, PVC, and plenum cables for various applications
- Teal cable jacket
- Rugged strain relief and hitch mechanism to maintain network integrity
- Suitable environments M₃L₃C₃E₃

Specifications

Attributes	Bulletin 1585J
Certifications	UL Listed
Material	<ul style="list-style-type: none"> • Conductor: Thin copper stranded • Contact: Gold-plated brass
Connectors	RJ45 Male to RJ45 Male, Cat 5e
Cable type	<ul style="list-style-type: none"> • Unshielded: 4- and 8-conductor, 24 AWG, Industrial Cat 5e • Shielded: 8-conductor, 26 AWG, Industrial Cat 5e
Enclosure type rating	IP20
Nominal outer diameter	5.84 mm (0.23 in.) ±10%
Operating temperature	-20...+60 °C (-4...+140 °F)
Voltage	300V

Color Code

Color Code	Face View RJ45 Pinout			
	8-pin			
A	8-pin		4-pin	
	1 White/Orange	TxData +	1 White/Orange	TxData +
	2 Orange	TxData -	2 Orange	TxData -
	3 White/Green	Recv Data +	3 White/Green	Recv Data +
	4 Blue	Unused	4 -	-
	5 White/Blue	Unused	5 -	-
	6 Green	Recv Data -	6 Green	Recv Data -
	7 White/Brown	Unused	7 -	-
	8 Brown	Unused	8 -	-

Product Selection

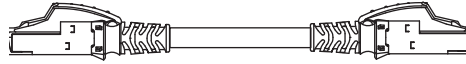

No. of Conductors	Jacket Material	Cable Type	Cable Rating	Cat. No. ⁽¹⁾					
				Straight to Straight	Right Angle to Straight	Left Angle to Straight	Right Angle to Left Angle	Left Angle to Left Angle	Right Angle to Right Angle
8	Teal riser, PVC	Unshielded twisted pair	UL CMR; cUL CMG; Standard TIA 568-B	1585J-M8PBJM-y	1585J-E8PBJM-y	1585J-L8PBJM-y	1585J-E8PBJL-y	1585J-L8PB JL-y	1585J-E8PB JE-y
8	Teal high-flex, TPE		Weld splatter, sunlight, and oil-resistant; UL CM, outdoor; cUL CM; Standard TIA 568-B, flex rated	1585J-M8TBJM-y	1585J-E8TBJM-y	1585J-L8TBJM-y	1585J-E8TBJL-y	1585J-L8TB JL-y	1585J-E8TB JE-y
4	Teal high-flex, TPE		Weld splatter, sunlight, and oil-resistant; UL CMG, CMX; cUL CMG; Standard TIA 568-B, flex rated	1585J-M4TBJM-y	1585J-E4TBJM-y	1585J-L4TBJM-y	1585J-E4TBJL-y	1585J-L4TB JL-y	1585J-E4TB JE-y
8	Teal riser, PVC	Braid over foil shield	UL CMR; CUR CMG, TIA B	1585J-M8CBJM-y	1585J-E8CBJM-y	1585J-L8CBJM-y	1585J-E8CBJL-y	1585J-L8CB JL-y	1585J-E8CB JE-y
8	Teal high-flex, PUR		C(ETL)US TYPE CMX; TIA 568-B, flex-rated, halogen-free	1585J-M8UBJM-y	1585J-E8UBJM-y	1585J-L8UBJM-y	1585J-E8UBJL-y	1585J-L8UB JL-y	1585J-E8UB JE-y
4			1585J-M4UBJM-y	1585J-E4UBJM-y	1585J-L4UBJM-y	1585J-E4UBJL-y	1585J-L4UB JL-y	1585J-E4UB JE-y	
8	Teal 600V, PVC	Foil shield	(UL) CMX, CMR; c(UL) CMG; (UL) PLTC or AWM 2570 80 °C 600V; TIA-568-B	1585J-M8HBJM-y	1585J-E8HBJM-y	1585J-L8HBJM-y	1585J-E8HBJL-y	1585J-L8HB JL-y	1585J-E8HB JE-y
4				1585J-M4HBJM-y	1585J-E4HBJM-y	1585J-L4HBJM-y	1585J-E4HBJL-y	1585J-L4HB JL-y	1585J-E4HB JE-y
8	Teal riser, PVC	Crossover cable		1585J-M8CBJM-yX	1585J-E8CBJM-yX	1585J-L8CBJM-yX	1585J-E8CBJL-yX	1585J-L8CB JL-yX	1585J-E8CB JE-yX

(1) Replace y with 2 [2 m (6.6 ft)], 5 [5 m (16.4 ft)], or 10 [10 m (32.8 ft)] for standard cable lengths (example 1585J-E8PB JE-y becomes 1585J-E8PB JE-5 for a 5 m cable).

Approximate Dimensions

Dimensions are shown in mm (in.). Dimensions are not intended to be used for installation purposes.

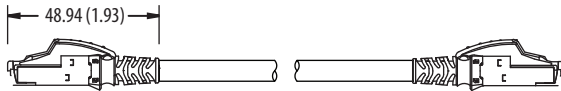

Example of Cordset

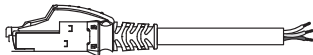

Example of Patchcord

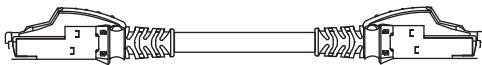

RJ45 Gigabit Cordset, Cat 6

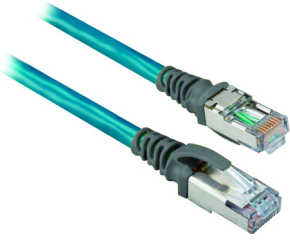

Features

- Flex-rated TPE cables for various applications
- Teal cable jacket
- Rugged strain relief and latch mechanism to maintain network integrity
- Suitable environments M₁L₁C₂E₂

Cordsets Product Selection

Shielding	Connector Style	Cable Type	Cable Length	Cat. No. (1)
Foil and braided shield	Straight male	8-conductor, teal high-flex TPE	2 m (6.56 ft)	1585J-M8TG-x
	Right angle male			1585J-E8TG-x

(1) Replace x with 2 [2 m (6.6 ft)], 5 [5 m (16.4 ft)], or 10 [10 m (32.8 ft)] for standard cable lengths (example 1585J-M8TG-x becomes 1585J-M8TG-5 for a 5 m cable).

Approximate Dimensions

Dimensions are shown in mm (in.). Dimensions are not intended to be used for installation purposes.

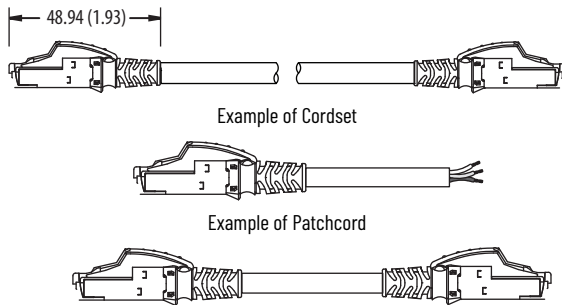

Specifications

Attributes	Bulletin 1585J
Certifications	UL Listed
Material	<ul style="list-style-type: none"> • Conductor: Thin copper stranded • Contact: Gold-plated brass
Connectors	RJ45 Male to RJ45 Male, Cat 6
Cable type	Shielded: 8-conductor, 24 AWG, Industrial Cat 6
Enclosure type rating	IP20
Nominal outer diameter	5.84 mm (0.23 in.) ±10%
Operating temperature	-20...+60 °C (-4...+140 °F)
Voltage	600V

Patchcords Product Selection

Shielding	Connector Style	Cable Type	Cable Length	Cat. No. (1)
Foil and braided shield	RJ45 straight male	8-conductor (4 pair), teal high-flex TPE	2 m (6.56 ft)	1585J-M8TGJM-x
	RJ45 straight male to right angle male			1585J-M8TGJE-x
	RJ45 right angle male to right angle male			1585J-E8TGJE-x

(1) Replace x with 2 [2 m (6.6 ft)], 5 [5 m (16.4 ft)], or 10 [10 m (32.8 ft)] for standard cable lengths (example 1585J-M8TGJE-x becomes 1585J-M8TGJE-2 for a 2 m cable).

Color Code

Color Code	Face View RJ45 Pinout			
	8-pin			
Side A Plug Pin	T568B	Side B Plug Pin	1000BASE-T	
1	White/Orange	1	BI_DA+ (bidirectional pair 1+)	
2	Orange	2	BI_DA- (bidirectional pair 1-)	
3	White/Green	3	BI_DB+ (bidirectional pair 2+)	
4	Blue	4	BI_DC+ (bidirectional pair 3+)	
5	White/Blue	5	BI_DC- (bidirectional pair 3-)	
6	Green	6	BI_DB- (bidirectional pair 2-)	
7	White/Brown	7	BI_DD+ (bidirectional pair 4+)	
8	Brown	8	BI_DD- (bidirectional pair 4-)	

RJ45 Red Cordset



Wiring

Color Code	Face View RJ45 Pinout			
	8-pin			
A	8-pin		4-pin	
	1 White/Orange	TxData +	1 White/Orange	TxData +
	2 Orange	TxData -	2 Orange	TxData -
	3 White/Green	Recv Data +	3 White/Green	Recv Data +
	4 Blue	Unused	4 -	-
	5 White/Blue	Unused	5 -	-
	6 Green	Recv Data -	6 Green	Recv Data -
	7 White/Brown	Unused	7 -	-
	8 Brown	Unused	8 -	-

Specifications

Attributes	Bulletin 1585J
Certifications	UL Listed
Material	<ul style="list-style-type: none"> Conductor: Thin copper stranded Contact: Gold-plated brass
Connectors	RJ45 Male to RJ45 Male, Cat 5e
Cable type	<ul style="list-style-type: none"> Unshielded: 4- and 8-conductor, 24 AWG, Industrial Cat 5e Shielded: 8-conductor, 26 AWG, Industrial Cat 5e
Enclosure type rating	IP20
Nominal outer diameter	5.84 mm (0.23 in.) ±10%
Operating temperature	-20...+60 °C (-4...+140 °F)

Approximate Dimensions

Dimensions are shown in mm (in.). Dimensions are not intended to be used for installation purposes.

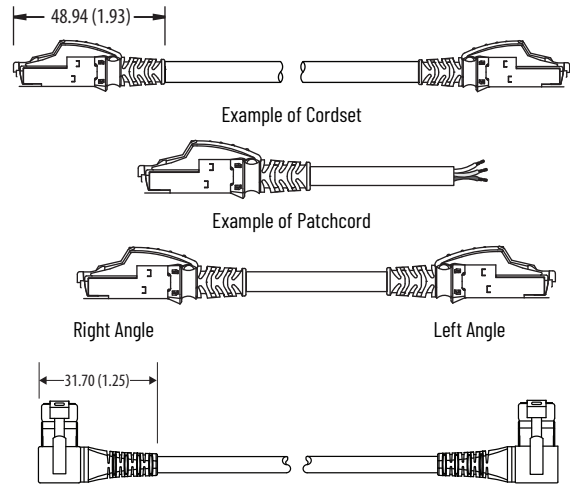

Cable Spool Product Selection

Jacket Material	Cable Type	No. of Conductors	Jacket Color	Wire Size [AWG]	Nominal Outer Diameter	Operating Temperature	Cable Rating	Cat. No. ⁽¹⁾
600V PVC	Foil shield	8 (four pairs)	Teal	22	8.13 ± 0.38 mm (0.32 in.)	-20...+80 °C (-4...+176 °F)	(UL) CMX, CMR; c(UL) CMG; (UL) PLTC or AWM 2570 80 °C 600V; TIA-568-B	1585-C8HB-Sx
			Red					1585-C8EB-Sx
		4 (two pairs)	Teal					1585-C4HB-Sx
			Red					1585-C4EB-Sx

(1) Replace x with 100 [100 m (328 ft)], 300 [300 m (984 ft)], or 600 [600 m (1969 ft)] for standard cable lengths (example 1585-C4HB-Sx becomes 1585-C4HB-S600 for a 600 m cable).

Patchcord Product Selection

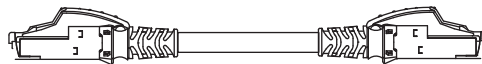

No. of Conductors	Jacket Material	Cable Type	Cable Rating	Cat. No. ⁽¹⁾					
				Straight to Straight	Right Angle to Straight	Left Angle to Straight	Right Angle to Left Angle	Left Angle to Left Angle	Right Angle to Right Angle
8	Red riser, PVC	Unshielded twisted pair	Weld splatter, sunlight, and oil-resistant; UL CM, outdoor; cUL CM; Standard TIA 568-B, flex rated	1585J-M8QBJM-y	1585J-E8QBJM-y	1585J-L8QBJM-y	1585J-E8QBJL-y	1585J-L8QBJL-y	1585J-E8QBJE-y
	Red high flex, TPE			1585J-M8VBJM-y	1585J-E8VBJM-y	1585J-L8VBJM-y	1585J-E8VBJL-y	1585J-L8VBJL-y	1585J-E8VBJE-y

(1) Replace y with 2 [2 m (6.6 ft)], 5 [5 m (16.4 ft)], or 10 [10 m (32.8 ft)] for standard cable lengths (example 1585J-E8PBJE-y becomes 1585J-E8PBJE-5 for a 5 m cable).

M12 Flex-rated



4-pin M12
D-Code Cordset

Features

- Over molded housing suitable for IP67 applications and harsh industrial environments where extreme vibration, shock, chemicals, and temperature are found.
- Flex-rated cable (must be tied down and not flexed within 152 mm [6 in.] of the connector).
- Custom termination of single-ended cordsets with one of several field attachable connectors.
- Designed to ODVA EtherNet/IP specifications and ISO IEC 24702, IEC 61918.
- Twisted pairs maintain signal balance through cable to provide high noise immunity and return loss.
- Suitable for noise environments M₃I₃C₃E₃.

Specifications

Attributes	Bulletin 1585D
Material	<ul style="list-style-type: none"> • Coupling nut: Nickel-plated brass • Housing: Polyurethane (PUR) • Contact: Gold-plated brass
Enclosure type rating	IP67
Nominal outer diameter	5.84 mm (0.23 in.) ±10%
Bend radius	10 x cable diameter
Operating temperature	-40...+75 °C (-40...+167 °F)

Cable Style

Cable Style	Cable Type	Wire Size [AWG]	Cable O.D. [mm (in.)]	Cable Rating
TPE, high flex, unshielded	4 conductor, unshielded twisted-pair (UTP), teal	24	5.6 (0.22)	Weld splatter, sunlight, and oil-resistant; UL CM, CMX; cUL CM; TIA 568B
PUR, foil and braided shield, high flex, halogen free	4 conductor, shielded twisted-pair (STP), teal	26	5.84 (0.23)	(ETL)US TYPE CMX; TIA 568B
PVC, 600V rated, foil shield	4 conductor, shielded twisted-pair (STP), teal	22	8.13 (0.32)	(UL) CMX, CMR; cUL CMG; (UL) PLTC or AWM 2570 80C 600V; TIA 568B

M12 Cordset Product Selection

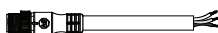

Cable Style	First End Connector	Second End Connector	Operating Temperature	Cat. No.
TPE, high flex, unshielded	Male M12 D-Code, straight	Flying leads	-40...+75 °C (-40...+167 °F)	1585D-M4TB-2
PUR, foil and braided shield, high flex, halogen free				1585D-M4UB-2
PVC, 600V rated, foil shield				1585D-M4HB-2

M12 Patchcord Product Selection

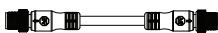

Cable Style	First End Connector	Second End Connector	Operating Temperature	Cat. No.
TPE, high flex, unshielded	Male M12 D-Code, straight	Male M12 D-Code, straight	-40...+75 °C (-40...+167 °F)	1585D-M4TBDM-2
	Male M12 D-Code, right angle	Male M12 D-Code, right angle		1585D-E4TBDE-2
	Male M12 D-Code, straight	Female M12 D-Code, straight		1585D-M4TBDE-2
		Male M12 D-Code, straight		1585D-M4TBDF-2
PUR, foil and braided shield, high flex, halogen free	Male M12 D-Code, right angle	Male M12 D-Code, right angle	-40...+75 °C (-40...+167 °F)	1585D-M4UBDM-2
	Male M12 D-Code, straight	Female M12 D-Code, straight		1585D-E4UBDE-2
		Male M12 D-Code, straight		Female M12 D-Code, straight
	PVC, 600V rated, foil shield	Male M12 D-Code, right angle		Male M12 D-Code, right angle
Male M12 D-Code, straight		Female M12 D-Code, straight	1585D-M4HBDM-2	
		Male M12 D-Code, straight	Female M12 D-Code, straight	1585D-E4HBDE-2
Male M12 D-Code, straight		Female M12 D-Code, straight	1585D-M4HBDE-2	

M12 to RJ45 Patchcord Product Selection

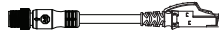

Cable Style	First End Connector	Second End Connector	Operating Temperature	Cat. No. ⁽¹⁾
TPE, high flex, unshielded	Male M12 D-Code, straight	RJ45	-40...+75 °C (-40...+167 °F)	1585D-M4TBJM-x
PUR, foil and braided shield, high flex, halogen-free				1585D-M4UBJM-x
PVC, 600V rated, foil shield			-20...+80 °C (-4...+176 °F)	1585D-M4HBJM-x

(1) Replace x with 1 [1 m (3.3 ft)], 2 [2 m (6.6 ft)], 5 [5 m (16.4 ft)], or 10 [10 m (32.8 ft)] for standard cable lengths (example 1585D-M4UBJM-x becomes 1585D-M4UBJM-5 for a 5 m cable).

Accessories

Description	Channel Bandwidth	Cat. No.
RJ45 insulation displacement connector (IDC)	Cat 6	1585J-M8CC-H ⁽¹⁾
RJ45 crimp connector with boot	Cat 5e	1585J-M8CC-C ⁽²⁾

(1) Qty. = 1 piece
 (2) Qty. = 50 pieces

Approximate Dimensions

Dimensions are shown in mm (in.). Dimensions are not intended to be used for installation purposes.

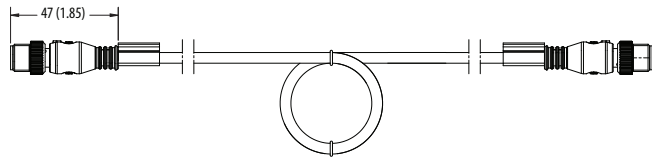

M12 Receptacle Flex-rated



4-pin M12 D-Code Receptacle to RJ45 Patchcord

Features

- Suitable for IP67 applications and harsh industrial environments where extreme vibration, shock, chemicals, and temperature are found
- Flex-rated cable (cable must be tied down and not flexed within 6 in. [152.4 mm] of the connector)
- Designed to ODVA EtherNet/IP specifications and ISO IEC 24702, IEC 61918
- Twisted pairs maintain signal balance through cable to provide high noise immunity and return loss
- M12 D-code receptacle is suitable for noisy environments $M_{313}C_{3E3}$.

Color Code

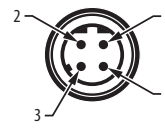
Color Code		
A	1 White-Orange 2 White-Green	3 Orange 4 Green

Specifications

Attribute	Bulletin 1585D
Material	<ul style="list-style-type: none"> • Coupling nut: Nickel-plated brass • Contact: Gold-plated brass
Cable type	Unshielded: teal TPE, 4-conductor, stranded tinned wire, Industrial Cat 5e
Enclosure type rating	IP67
Nominal outer diameter	5.84 mm (0.23 in.) ±10%
Mounting	Front-mount
Operating temperature	-40...+75 °C (-40...+167 °F)
Cable Rating	TIA 568B, flex-rated, 24 AWG, UL, c-UL
Voltage	300V

Color Code

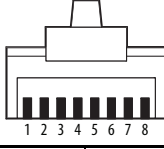
Color Code				
	8-pin		4-pin	
A	1 White/Orange	TxData +	1 White/Orange	TxData +
	2 Orange	TxData -	2 Orange	TxData -
	3 White/Green	Recv Data +	3 White/Green	Recv Data +
	4 Blue	Unused	4 -	-
	5 White/Blue	Unused	5 -	-
	6 Green	Recv Data -	6 Green	Recv Data -
	7 White/Brown	Unused	7 -	-
	8 Brown	Unused	8 -	-

Connector Product Selection

First End Connector	Second End Connector	Cable Type	Cat. No. (1)
Female M12 D-Code Receptacle, Front Mount	RJ45	Unshielded twisted-pair, 4-conductor, teal TPE, flex rated	1585D-D4TBJM-x
		Foil and braided shield, 4-conductor, teal PUR, flex rated, halogen-free	1585D-D4UBJM-x

(1) Replace x with 1 [1 m (3.3 ft)], 2 [2 m (6.6 ft)], 5 [5 m (16.4 ft)], 10 [10 m (32.8 ft)], or 15 [15 m (49.2 ft)] for standard cable lengths (example 1585D-D4TBJM-x becomes 1585D-D4TBJM-2 for a 2 m cable).

Color Code Pinout

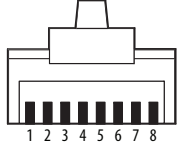
Color Code	Face View Pinout (Female)	Face View RJ45 Pinout
	4-pin	
A	 <p>1 White/Orange 2 White/Green 3 Orange 4 Green</p>	 <p>1 White/Orange TxData + 2 Orange TxData - 3 White/Green Recv Data + 4 Blue Unused 5 White/Blue Unused 6 Green Recv Data - 7 White/Brown Unused 8 Brown Unused</p>

Approximate Dimensions

Dimensions are shown in mm (in.). Dimensions are not intended to be used for installation purposes.

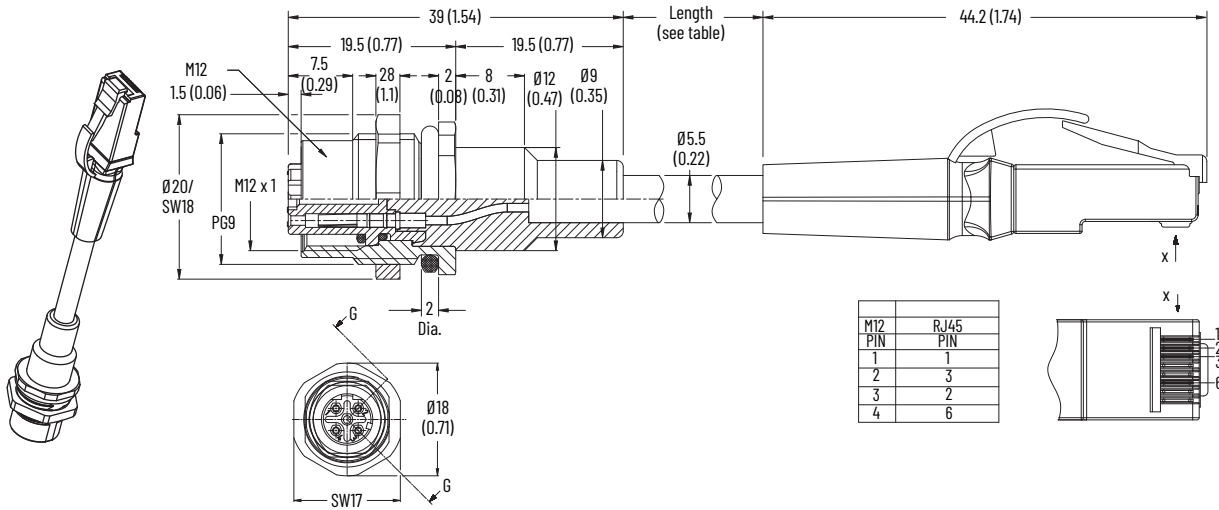

M12 Xcode Flex-rated Gigabit



8-pin M12 Xcode Cordset, Cat 6

Features

- Over-molded housing suitable for IP67 applications and harsh industrial environments where extreme vibration, shock, chemicals, and temperature are found.
- Flex-rated cable (must be tied down and not flexed within 152.4 mm [6 in.] of the connector).
- Designed to EtherNet/IP specifications and ISO IEC 11801, IEC 61918.
- Twisted pairs maintain signal balance through cable to provide high noise immunity and low return loss.
- Suitable for noise environments $M_{31}C_3E_3$.

Specifications

Attributes	Bulletin 1585D
Material	<ul style="list-style-type: none"> • Coupling nut: Nickel-plated brass • Housing: Polyurethane (PUR) • Contact: Gold-plated brass
Cable type	Shielded: teal PUR, 4 twisted pairs, 26 AWG, Industrial Cat 6, sunlight- and oil-resistant
Nominal outer diameter	5.84 mm (0.23 in.) $\pm 10\%$
Bend radius	10 x cable diameter
Cable rating	Shielded: Standard TIA 568-B, ISO/IEC 11801, flex-rated, 26 AWG, halogen-free, Type CMX
Enclosure type rating	IP67
Operating temperature	-40...+80 °C (-40...+176 °F)

Wiring Diagram

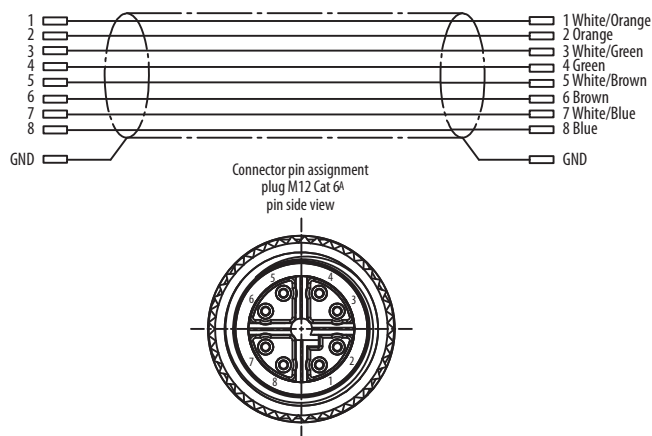

Product Selection

Patchcord Description	Shielding	Connector Style	Cable Type	Cable Length	Cat. No.
M12 Xcode to M12 Xcode	Foil and braided shield	Straight male	Shielded teal PUR, 4 twisted pairs, 26 AWG, Industrial Cat 6, UL Listed, sunlight- and oil-resistant	1 m (3.28 ft)	1585D-M8UGDM-1
M12 Xcode to RJ45					1585D-M8UGJM-1

Approximate Dimensions

Dimensions are shown in mm (in.). Dimensions are not intended to be used for installation purposes.

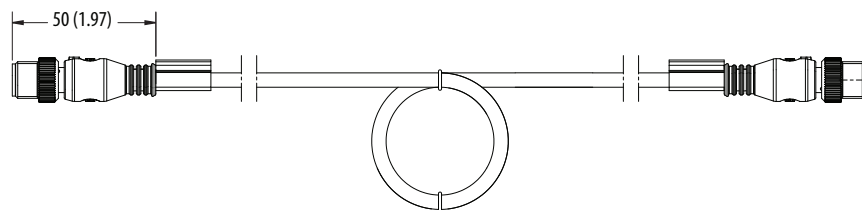

Example of M12 to M12 Patchcord

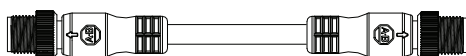

Example of M12 to RJ45 Patchcord

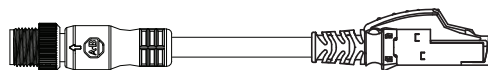

M12 Red



4-pin M12 D-Code Cordset

Features

- Over molded housing suitable for IP67 applications and harsh industrial environments where extreme vibration, shock, chemicals, and temperature are found.
- Flex-rated cable (must be tied down and not flexed within 152.4 mm [6 in.] of the connector).
- Custom termination of single-ended cordsets with one of several field attachable connectors.
- Designed to ODVA EtherNet/IP specifications and ISO IEC 24702, IEC 61918.
- Twisted pairs maintain signal balance through cable to provide high noise immunity and return loss.
- Suitable for noise environments M₃I₃C₃E₃.

M12 Pinout

Color Code		
A	1 White-Orange 2 White-Green	3 Orange 4 Green

Specifications

Attributes	Bulletin 1585D
Material	<ul style="list-style-type: none"> • Coupling nut: Nickel-plated brass • Housing: Polyurethane (PUR) • Contact: Gold-plated brass
Nominal outer diameter	5.84 mm (0.23 in.) ±10%
Enclosure type rating	IP67
Bend radius	10 x cable diameter

RJ45 Pinout

Color Code				
	8-pin	4-pin		
A	1 White/Orange	TxData +	1 White/Orange	TxData +
	2 Orange	TxData -	2 Orange	TxData -
	3 White/Green	Recv Data +	3 White/Green	Recv Data +
	4 Blue	Unused	4 -	-
	5 White/Blue	Unused	5 -	-
	6 Green	Recv Data -	6 Green	Recv Data -
	7 White/Brown	Unused	7 -	-
	8 Brown	Unused	8 -	-

Product Selection

Cable Style	First End Connector	Second End Connector	Operating Temperature	Cat. No.
Red high flex TPE, unshielded	Male M12 D-Code, straight		-40...+75 °C (-40...+167 °F)	1585D-M4VBDM-2
Red high flex PUR, foil and braided shield, high flex, halogen-free				1585D-M4FBDM-2
Red 600V PVC, 600V rated, foil shield			-20...+80 °C (-4...+176 °F)	1585D-M4EBDM-2

Approximate Dimensions

Dimensions are shown in mm (in.). Dimensions are not intended to be used for installation purposes.

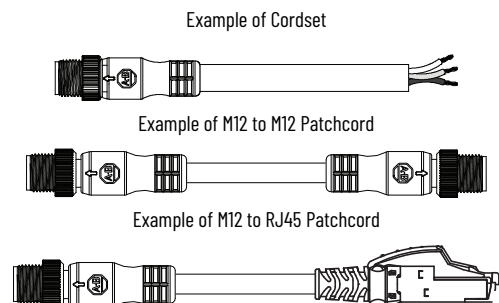
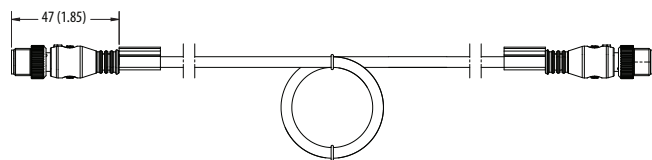

RJ45 Field Attachable Connector

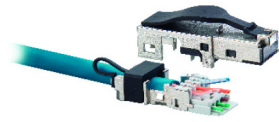

RJ45 Insulation Displacement Connector (IDC)



RJ45 Crimp

Specifications

Attribute	Bulletin 1585J
Certifications	UL Listed
Connector type	RJ45 male
Enclosure type rating	IP20
Operating temperature	-40...+70 °C (-40...+158 °F)

IDC Connector Features

- 27...24 AWG (solid wire) or 27...22 AWG (stranded wire) conductors
- 360° shielding
- Reuse IDC connector up to five times
- No tools or conductor stripping required
- Cat 6

Crimp Connector Features

- 26...24 AWG
- Standard crimp connector with rugged boot
- Cat 5e

Product Selection

Description	Electrical Connection	Housing Material	Insulation Material	Contact Material	Channel Bandwidth	Cat. No.
RJ45 insulation displacement connector (IDC)	—	Die-cast zinc	Plastic	Gold-plated copper alloy	Cat 6	1585J-M8CC-H ⁽¹⁾
RJ45 crimp connector with boot	150V, 1.5 A	Clear polycarbonate			Cat 5e	1585J-M8CC-C ⁽²⁾

(1) Qty. = 1 piece

(2) Qty. = 50 pieces

Face View RJ45 Pinout

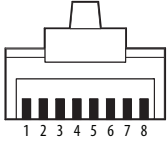
Color Code	Face View RJ45 Pinout			
	8-pin			
				
A	8-pin		4-pin	
	1 White/Orange 2 Orange 3 White/Green 4 Blue 5 White/Blue 6 Green 7 White/Brown 8 Brown	TxData + TxData - Recv Data + Unused Unused Recv Data - Unused Unused	1 White/Orange 2 Orange 3 White/Green 4 — 5 — 6 Green 7 — 8 —	TxData + TxData - Recv Data + Unused Unused Recv Data - Unused Unused

Approximate Dimensions

Dimensions are shown in mm (in.). Dimensions are not intended to be used for installation purposes.

RJ45 Insulation Displacement Connector (IDC)

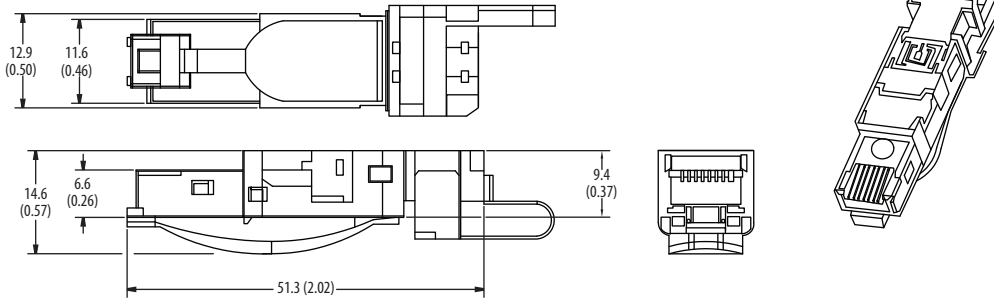

RJ45 Crimp Connector

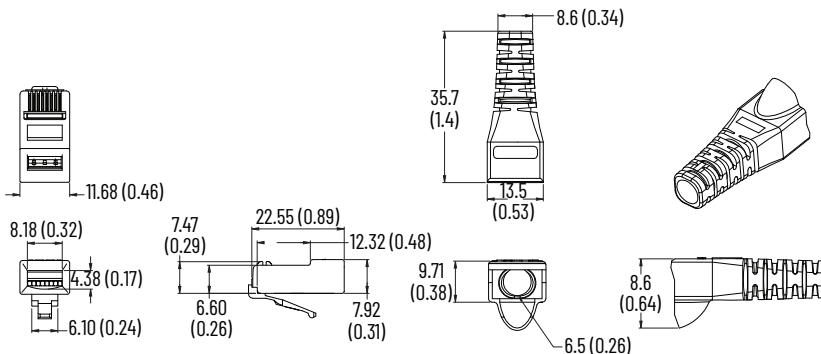

M12 Insulation Displacement Connectors (IDC)



Field Attachable

Specifications

Attribute	Bulletin 1585D
Material	<ul style="list-style-type: none"> Coupling nut: Zinc die-cast Connector shell: Zinc die-cast or polyamide Contact: Gold-plated brass
IDC installations, max	10x
Conductor outer diameter	<ul style="list-style-type: none"> Unshielded: 26...22 AWG: 1.0...1.6 mm (0.04...0.063 in.) Shielded: 24...22 AWG: 1.2...1.6 mm (0.04...0.063 in.)
Assembly rating	32V, 4 A
Enclosure type rating	IP67
Operating temperature	-25...+85 °C (-13...+185 °F)
Installation temperature	-5...+50 °C (23...185 °F)

Features

- Field installable with no hand tools needed
- Straight male or female shielded versions
- Allows easy modification of existing cable installations
- Insulation displacement technology for secure installation with excellent reliability
- Metal body unit excellent in shielding applications

Product Selection

No. of Pins	Connector Material	Cable Diameter [mm (in.)]	Wire Size, AWG	Assembly Rating	Dimensions	Cat. No.	
						Straight Female	Straight Male
4	Polyamide small body unshielded	4.0...5.1 (0.16...0.20)	26...22	32V, 4 A	See Figure A on page 20 .	—	1585D-M4DC-H
	Zinc die-cast large body shielded	5.5...7.2 (0.22...0.28)	24...22		See Figure B on page 20 .	1585D-F4DC-SH	1585D-M4DC-SH

Face View Pinout Face View M12 Pinout

Color Code	4-pin	
A	1 White-Orange 2 White-Green	3 Orange 4 Green

Approximate Dimensions

Dimensions are shown in mm (in.). Dimensions are not intended to be used for installation purposes.

M12 Insulation Displacement Connectors

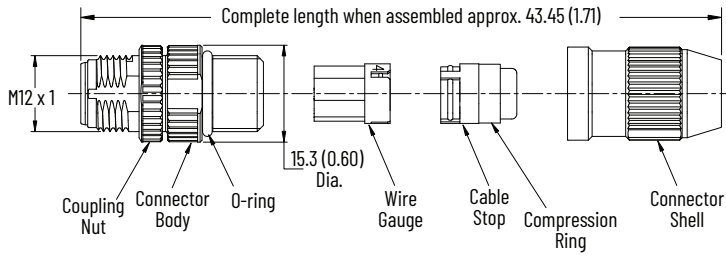
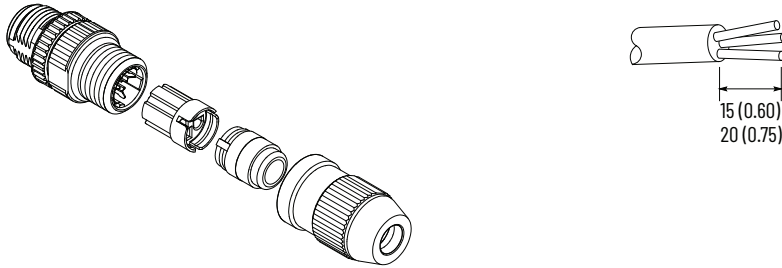

Figure A

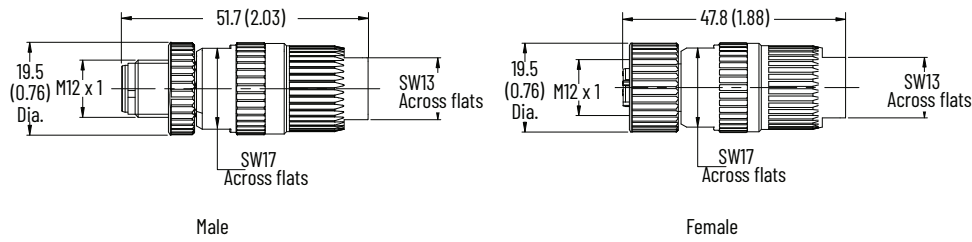
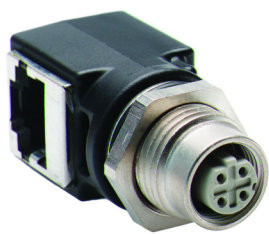

Figure B

M12 to RJ45 Bulkhead Connector



Field Attachable

Specifications

Attributes	Bulletin 1585A
Certifications	UL Recognized for Canada and USA
Material	<ul style="list-style-type: none"> Receptacle shell: Nickel-plated brass Contact: Brass with nickel plating
Wire insulation	Oil-resistant PVC, 22 AWG stranded copper, 300V, UL Recognized
Assembly rating	32V, 4 A
Enclosure type rating	IP67, 1200 psi (8270 kPa) washdown
Operating temperature	-20...+85 °C (-4...+185 °F)

Product Selection

Description	Connector Material	Panel Mount	Assembly Rating	Cat. No.
Female M12 receptacle to RJ45 female adapter right angle	Polyamide and brass with nickel plating	PG 9 threads	22 AWG, 32V, 4 A	1585A-DD4JD

Approximate Dimensions

Dimensions are shown in mm (in.). Dimensions are not intended to be used for installation purposes.

M12 to RJ45 Bulkhead Connector

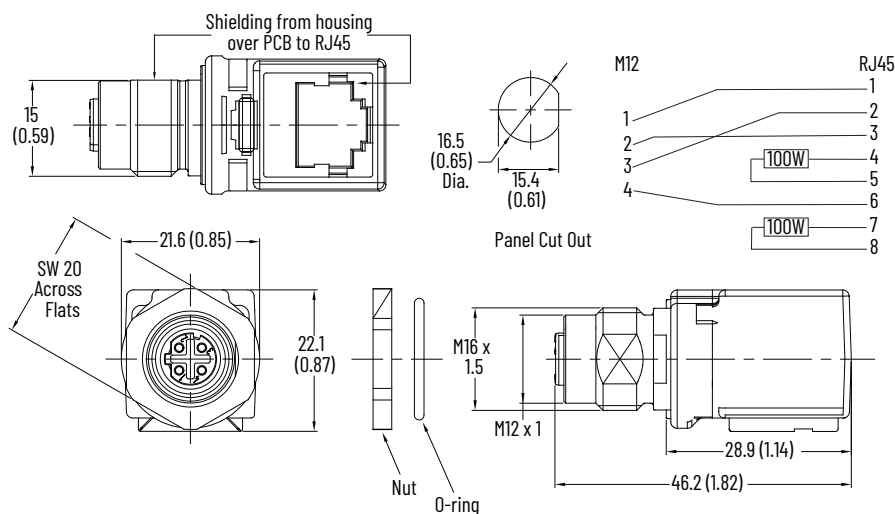

Additional Resources

These documents contain additional information concerning related products from Rockwell Automation.

Resource	Description
Industrial Ethernet Media Brochure, publication 1585-BR001	Provides an overview of Ethernet Media products that Rockwell Automation offers.
Industrial Automation Wiring and Grounding Guidelines, publication 1770-4.1	Provides general guidelines for installing a Rockwell Automation industrial system.
Product Certifications website, rok.auto/certifications .	Provides declarations of conformity, certificates, and other certification details.

You can view or download publications at rok.auto/literature.

Rockwell Automation Support

Use these resources to access support information.

Technical Support Center	Find help with how-to videos, FAQs, chat, user forums, and product notification updates.	rok.auto/support
Knowledgebase	Access Knowledgebase articles.	rok.auto/knowledgebase
Local Technical Support Phone Numbers	Locate the telephone number for your country.	rok.auto/phonesupport
Literature Library	Find installation instructions, manuals, brochures, and technical data publications.	rok.auto/literature
Product Compatibility and Download Center (PCDC)	Download firmware, associated files (such as AOP, EDS, and DTM), and access product release notes.	rok.auto/pcdc





Documentation Feedback

Your comments help us serve your documentation needs better. If you have any suggestions on how to improve our content, complete the form at rok.auto/docfeedback.

Allen-Bradley, Armor, expanding human possibility, On-Machine, and Rockwell Automation are trademarks of Rockwell Automation, Inc.
ControlNet, DeviceNet, and EtherNet/IP is a trademark of ODVA, Inc.
Trademarks not belonging to Rockwell Automation are property of their respective companies.

Rockwell Automation maintains current product environmental compliance information on its website at rok.auto/pec.

Rockwell Otomasyon Ticaret A.Ş. Kar Plaza İş Merkezi E Blok Kat:6 34752, İçerenköy, İstanbul, Tel: +90 (216) 5698400 EEE Yönetmeliğine Uygundur

Connect with us.    

rockwellautomation.com ————— expanding **human possibility**[®]

AMERICAS: Rockwell Automation, 1201 South Second Street, Milwaukee, WI 53204-2496 USA, Tel: (1) 414.382.2000, Fax: (1) 414.382.4444

EUROPE/MIDDLE EAST/AFRICA: Rockwell Automation NV, Pegasus Park, De Kleetlaan 12a, 1831 Diegem, Belgium, Tel: (32) 2 663 0600, Fax: (32) 2 663 0640

ASIA PACIFIC: Rockwell Automation, Level 14, Core F, Cyberport 3, 100 Cyberport Road, Hong Kong, Tel: (852) 2887 4788, Fax: (852) 2508 1846

Publication 1585-TD001H-EN-P - March 2022

Supersedes Publication Supersedes Publication 1585-TD001G-EN-P - March 2021

Copyright © 2022 Rockwell Automation, Inc. All rights reserved. Printed in the U.S.A.