

T-SERIES LARGE CAPACITY OUTDOOR

T62

 20000 BTU/Hr.
5860 Watts

T70-36

 36000 BTU/Hr.
10548 Watts

T70-60

 59000 BTU/Hr.
17287 Watts

INDUSTRY STANDARDS

UL/cUL Listed; Type 12, 3R, 4; 4X optional; File No. SA6453

 CE
EAC
Telcordia GR-487 capable

APPLICATION

- Industrial automation
- Telecommunications equipment
- Package handling equipment
- Security and defense systems
- And more

FEATURES

- Stock models equipped with head pressure control for low-ambient operation, compressor heater, coated condenser coil, malfunction switch, thermostat and heater package
- R-407C earth-friendly refrigerant
- Models for 230 and 460 VAC power input
- UL Listed to save customers time and money with agency approvals (some models UL recognized)
- Outdoor model operating temperature range from -40 F/-40 C to 131 F/55 C
- Exterior and fully recessed mounting options on many models
- Compact footprint to minimize real estate and maximize capacity
- Reliable mechanical thermostat on enclosure side of the unit
- Dual condenser-side air movers for performance redundancy
- Painted galvanized sheet-metal cover for rugged factory and outdoor environments
- Easy-mount flanges for simple installation

- Cleanable, reusable aluminum mesh filter protects coils for maximum cooling performance
- Mounting hardware, gaskets and user manual furnished with the unit
- Every unit functionally tested before shipping
- Standard Outdoor Air Conditioner models also include:
 - Telcordia GR-487 capable
 - Thermostat
 - Corrosion-resistant components
 - Malfunction switch
 - Compressor heater
 - Head pressure control
 - Enclosure heater

FINISH

- RAL 7035 light-gray, semi-textured powder-coat paint
- Other colors and textures available

OPTIONS

- Thermostat Malfunction Package
- Special Voltage Package
- Outdoor Package
- Harsh Environment Package*
- Stainless Steel Package*
- Heater Package
 - * PROAIR A/C may be more appropriate. Refer to PROAIR A/C Chapter. Consult the Factory for availability and catalog number.

Performance Data **T62 20000 BTU/Hr. (5860 Watt) Models**

CATALOG NUMBER		
Outdoor Model with Heat Pkg.	T622226G150	T622246G400
Outdoor Model/SST/Corrosion/4X	T622226G102	—
Outdoor Model/SST/Corrosion/4X/Heater	T622226G151	—
COOLING PERFORMANCE		
Nominal:		
BTU/Hr.	20500/23500	20500/23500
Watts	6007/6886	6007/6886
At 131 F/131 F (55 C/55 C):		
BTU/Hr. (50/60 Hz)	20860/23927	20860/23927
W (50/60 Hz)	6113/7012	6113/7012
At 95 F/95 F (35 C/35 C):		
BTU/Hr. (50 /60 Hz)	18258/20256	18258/20256
W (50/60 Hz)	5351/5936	5351/5936
Refrigerant		R-407C
Refrigerant Charge (ounces/grams)	42/1300	42/1300
Operating Temperature Range:		
Maximum (°F/°C)	131/55	131/55
Minimum (°F/°C)	-40/-40	-40/-40
Airflow at 0 Static Pressure:		
Internal loop 50 Hz (CFM / m ³ /hr.)	570/968	570/968
External loop 50 Hz (CFM / m ³ /hr.)	1443/2452	1443/2452
Internal loop 60 Hz (CFM / m ³ /hr.)	673/1143	673/1143
External loop 60 Hz (CFM / m ³ /hr.)	1797/3053	1797/3053
Max. Heater W (Outdoor Models)	2000	Up to 3000 (Optional)
ELECTRICAL DATA		
Rated Voltage	230	460V 1PH
Frequency (Hz)	50/60	50/60
Operating Range	+/- 10%	+/- 10%
Max. Power Consumption (W at 50/60 Hz)	4370/5060	7000/9200
Max. Nominal Current (A at 50/60 Hz)	19/22	10.5/12
Min. Circuit Ampacity (A)	25.2	12.6
Max. Overcurrent Protection (A)	35	20
Starting Current (A)	60	30
Agency Approvals	UL/cUL Listed CE EAC	UL/cUL Listed CE EAC
Power Input Description	Terminal block	Terminal block
ENCLOSURE PROTECTION		
UL Type	Type 12, 3R, 4 standard Type 4X Stainless steel optional	
CONTROLLER		
Description	Basic mechanical thermostat	
Thermostat Location	Enclosure side on all base models	
Factory Thermostat Setting (°F/°C)	80/27	
SOUND LEVEL		
At 1.5 Meters	71 dB(A)	
UNIT CONSTRUCTION		
Material	Galvanized sheet metal standard Stainless steel optional	
Finish	RAL 7035 light-gray, semi-textured powder-coat paint standard	
UNIT DIMENSIONS		
Height (in./mm)	61.77/1568.96	61.77/1568.96
Width (in./mm)	19.91/505.71	19.91/505.71
Depth (in./mm)	17.36/440.94	17.36/440.94
Weight (lb./kg)	218/99.1	258/117

Performance Curves for T62 Models 20000 BTU/Hr. (5860 Watt)

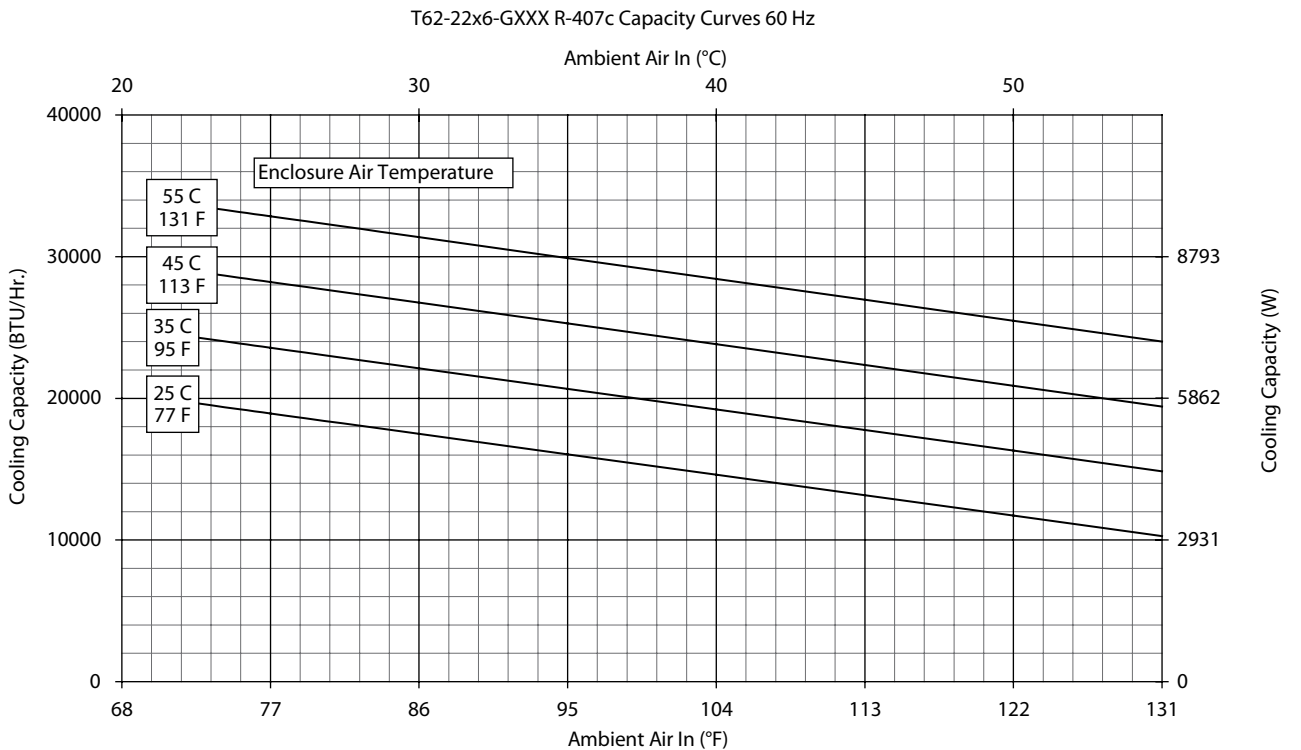
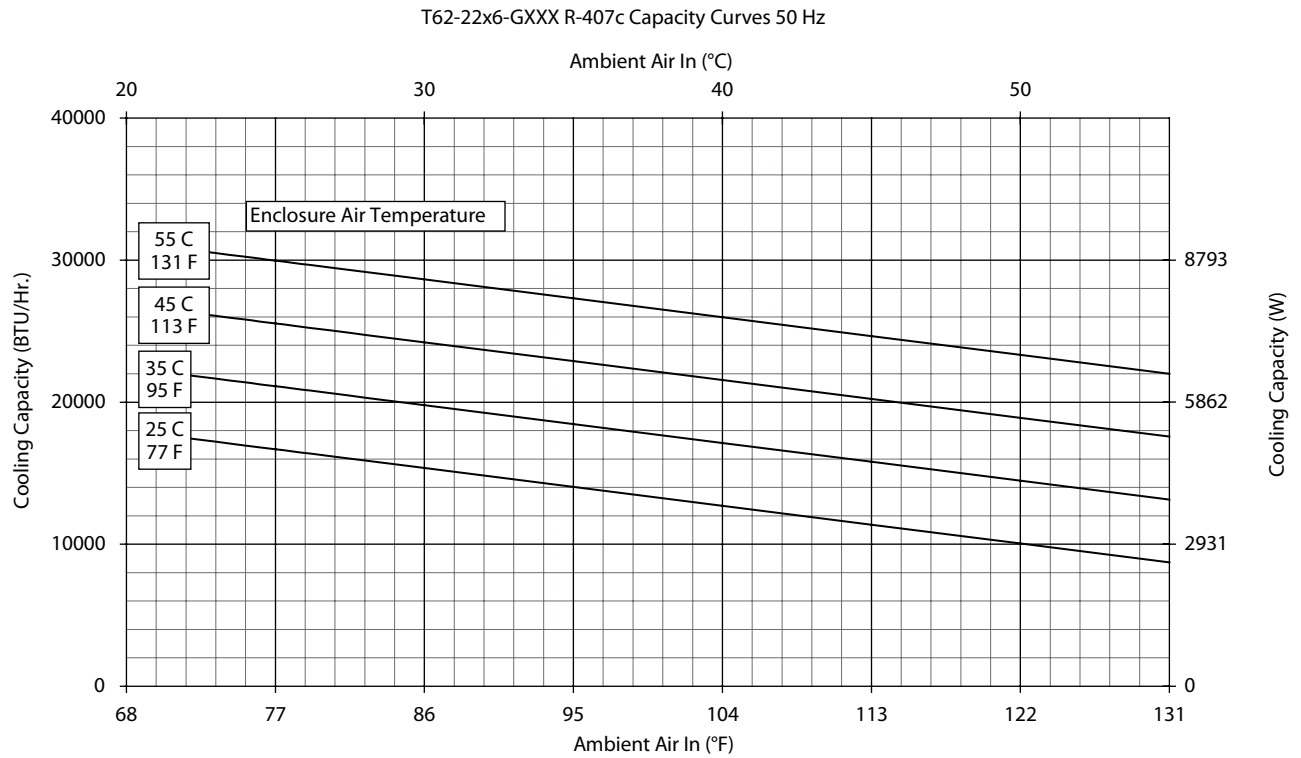

T62 Models 20000 BTU/Hr. (5860 Watt)

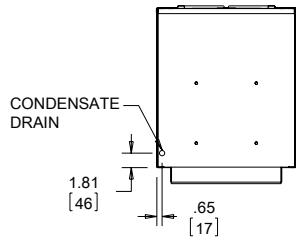
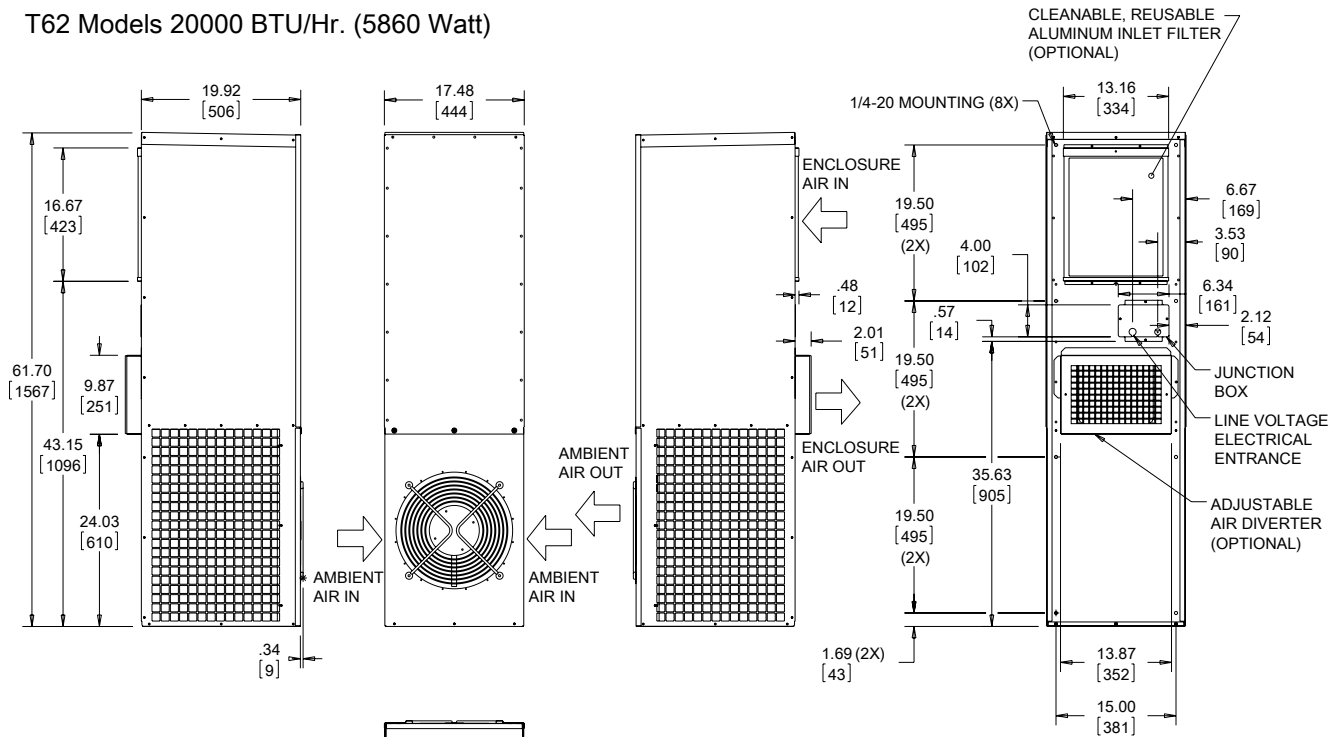

NOTE:
 1. MOUNTING GASKET SUPPLIED (NOT SHOWN).
 2. UNITS: in. [mm]

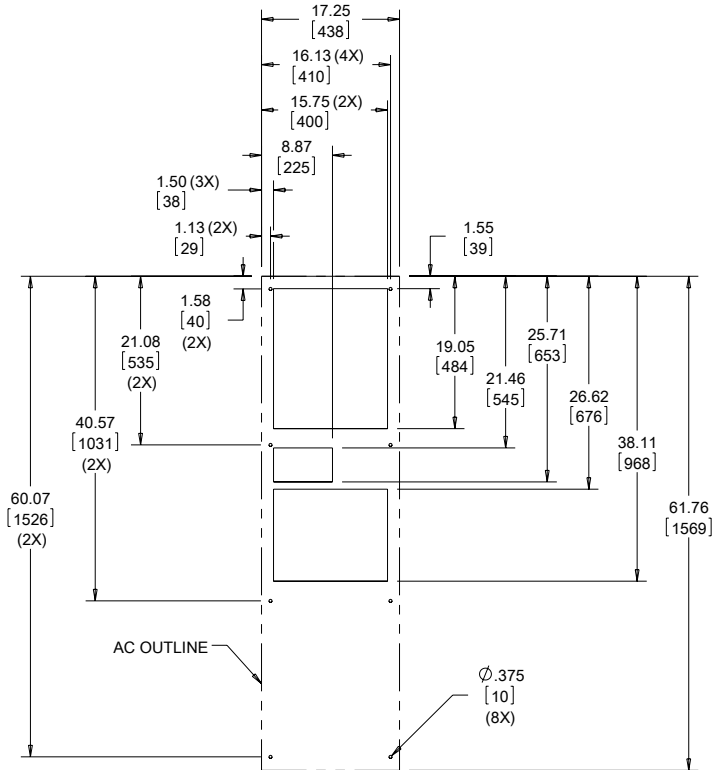

Cutout Dimensions

89043921

Visit www.nVent.com/HOFFMAN to download 2D and 3D CAD drawings into the overall design of your electrical system.

Performance Data T70-36 36000 BTU/Hr. (10548 Watt) Models

CATALOG NUMBER	T703626G150	T703646G400
COOLING PERFORMANCE		
Nominal:		
BTU/Hr.	39000/43000	
Watts	11430/12602	
At 131 F/131 F (55 C/55 C):		
BTU/Hr. (50/60 Hz)	38613/42930	
W (50/60 Hz)	11316/12570	
At 95 F/95 F (35 C/35 C):		
BTU/Hr. (50 /60 Hz)	31364/36130	
W (50/60 Hz)	9192/10579	
Refrigerant	R-407C	
Refrigerant Charge (ounces/grams)	110/3118	
Operating Temperature Range:		
Maximum (°F/°C)	131/55	
Minimum (°F/°C)Minimum (°F/°C)	-40/-40	
Airflow at 0 Static Pressure:		
Internal loop 50 Hz (CFM / m ³ /hr.)	1085/1843	
External loop 50 Hz (CFM / m ³ /hr.)	2176/3697	
Internal loop 60 Hz (CFM / m ³ /hr.)	1171/1989	
External loop 60 Hz (CFM / m ³ /hr.)	2347/3987	
Max. Heater W (Outdoor Models)	2000 Standard (5000 Optional)	
ELECTRICAL DATA		
Rated Voltage	230	460
Frequency (Hz)	50/60	60
Operating Range	+/- 10%	+/- 10%
Max. Power Consumption (W at 50/60 Hz)	8280	8280
Max. Nominal Current (A at 50/60 Hz)	36	18
Min. Circuit Ampacity (A)	40	20
Max. Overcurrent Protection (A)	50	25
Starting Current (A)	104	52
Agency Approvals	UL/cUL Listed CE EAC Others available upon request	
Power Input Description	Terminal block	
ENCLOSURE PROTECTION		
UL Type	Type 12, 3R, 4 standard Type 4X Stainless steel optional UL/cUL Listed	
International Rating	UL/cUL Listed	
CONTROLLER		
Description	Basic mechanical thermostat	
Thermostat Location	Enclosure side on all base models	
Factory Thermostat Setting (°F/°C)	80/27	
SOUND LEVEL		
At 1.5 Meters	66 dB(A)	
UNIT CONSTRUCTION		
Material	Galvanized sheet metal standard Stainless steel optional	
Finish	RAL 7035 light-gray, semi-textured powder-coat paint standard	
UNIT DIMENSIONS		
Height (in./mm)	69.8/1772	
Width (in./mm)	22.8/578	
Depth (in./mm)	20.94/532	
Weight (lb./kg)	260/118	

Performance Curves for T70 Models 36000 BTU/Hr. (10548 Watt)

T70-36X6-GXXX R-407c Capacity Curves 50 Hz

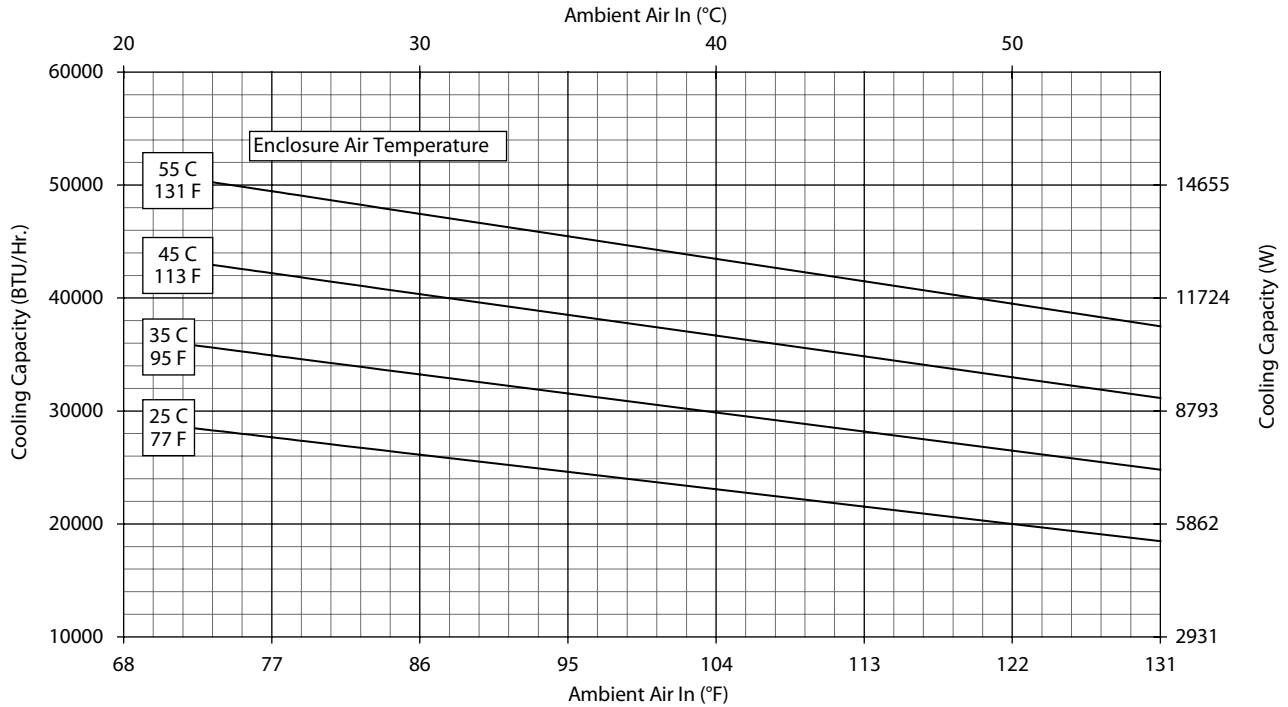

T70-36X6-GXXX R-407c Capacity Curves 60 Hz

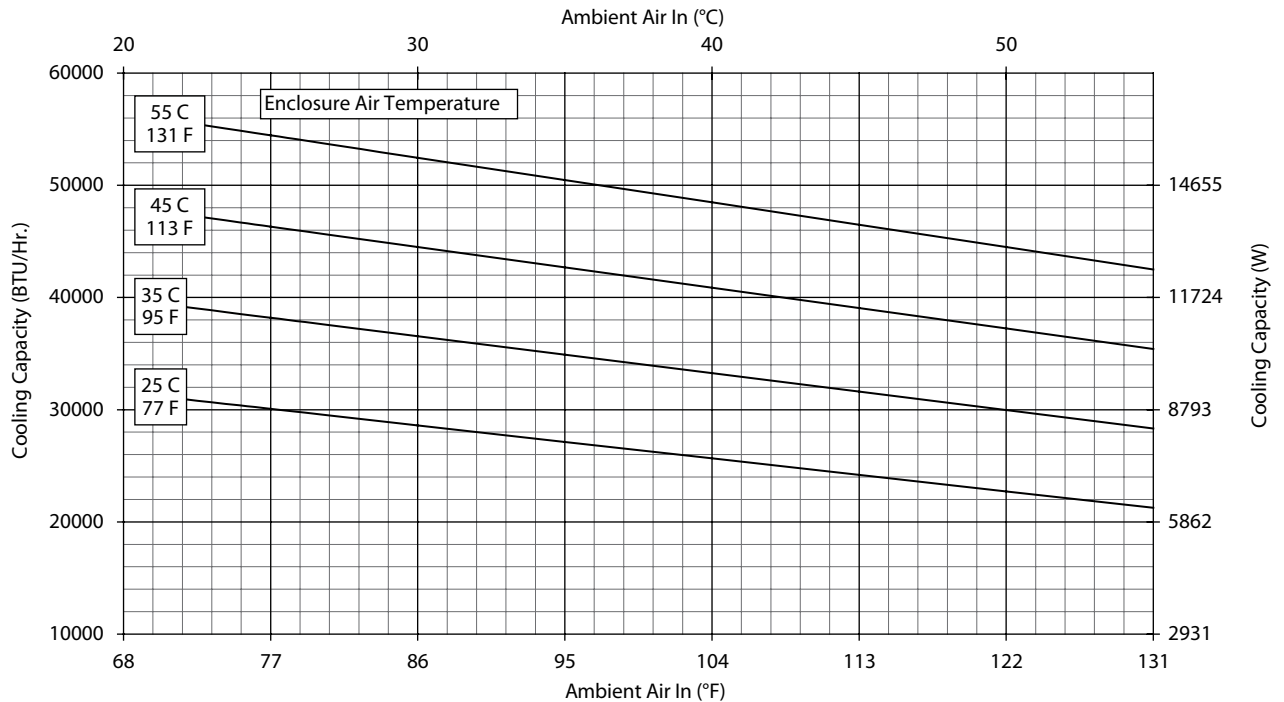

T70 Models 36000 BTU/Hr. (10548 Watt)

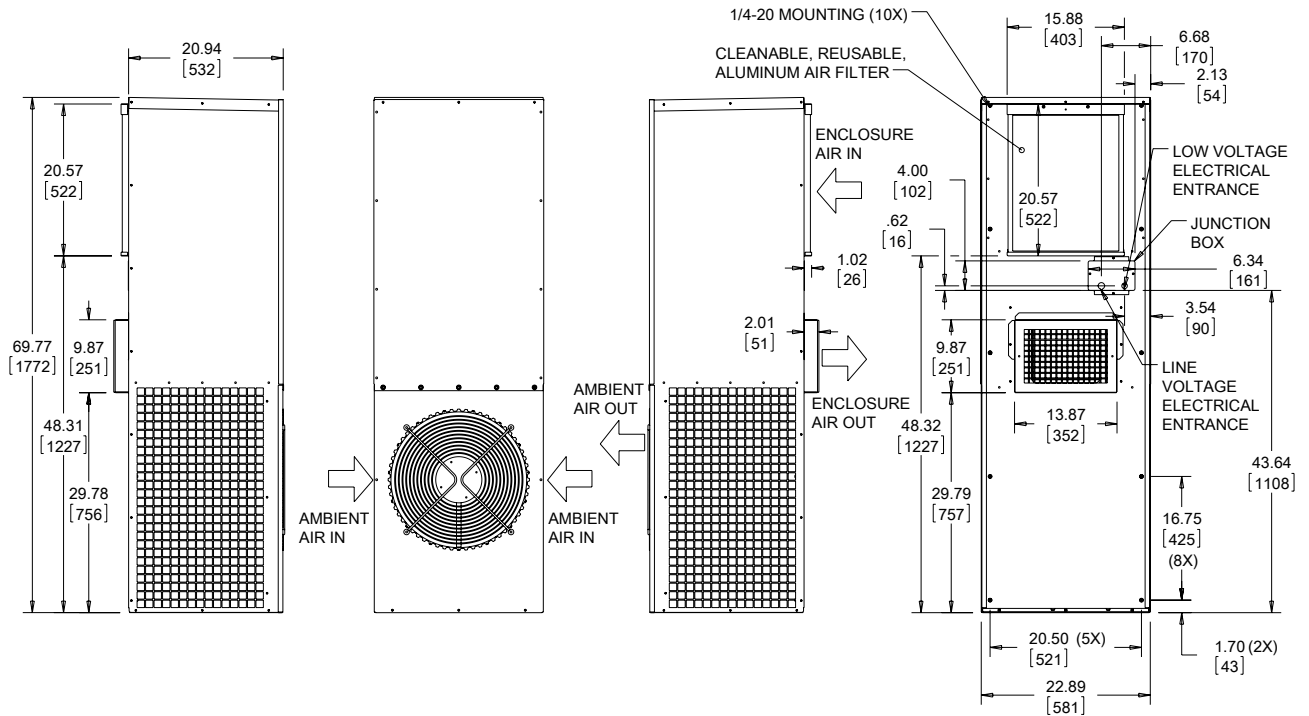

NOTE:
 1. MOUNTING GASKET SUPPLIED (NOT SHOWN).
 2. UNITS: in. [mm]

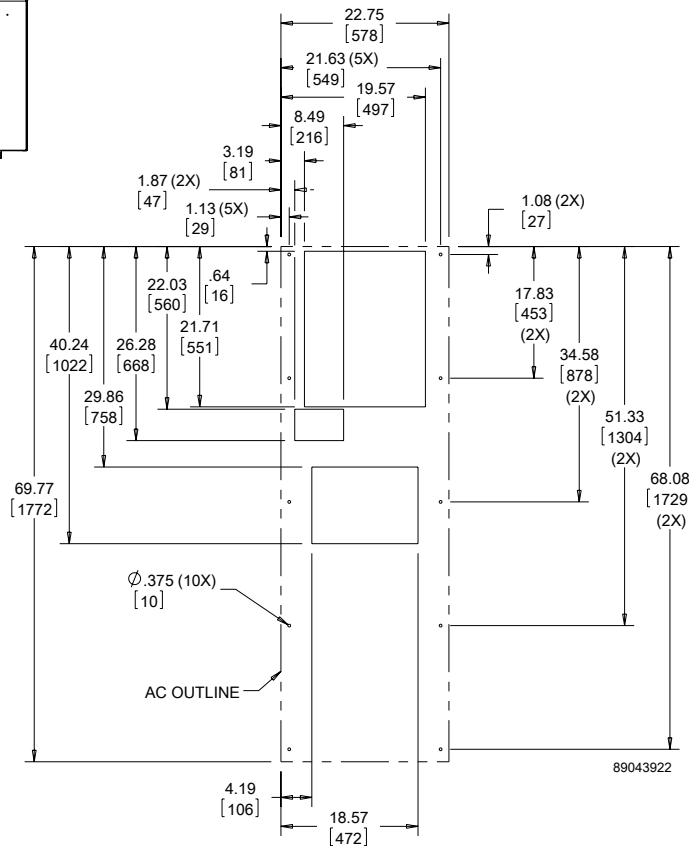

Cutout Dimensions

Visit www.nVent.com/HOFFMAN to download 2D and 3D CAD drawings into the overall design of your electrical system.

Performance Data T70-60 59000 BTU/Hr. (17287 Watt) Models

CATALOG NUMBER	T706026G150	T706046G400
COOLING PERFORMANCE		
Nominal:		
BTU/Hr.	51900/60000	
Watts	15210/17584	
At 122 F/122 F (50 C/50 C):		
BTU/Hr. (50/60 Hz)	51900/60000	
W (50/60 Hz)	15210/17584	
At 95 F/95 F (35 C/35 C):		
BTU/Hr. (50 /60 Hz)	47122/54500	
W (50/60 Hz)	13810/15972	
Refrigerant	R-407C	
Refrigerant Charge (ounces/grams)	150/4252	
Operating Temperature Range:		
Maximum (°F/°C)	122/50	
Minimum (°F/°C)	-40/-40	
Airflow at 0 Static Pressure:		
Internal loop 50 Hz (CFM / m ³ /hr.)	1510/2565	
External loop 50 Hz (CFM / m ³ /hr.)	2716/4614	
Internal loop 60 Hz (CFM / m ³ /hr.)	1629/2767	
External loop 60 Hz (CFM / m ³ /hr.)	2931/4979	
Max. Heater W (Outdoor Models)		
ELECTRICAL DATA		
Rated Voltage	200/230	420/460
Frequency (Hz)	50/60	50/60
Operating Range	+/- 10%	+/- 10%
Max. Power Consumption (W at 50/60 Hz)	7000/9200	6426/7038
Max. Nominal Current (A at 50/60 Hz)	35/40	15.3
Min. Circuit Ampacity (A)	58	29
Max. Overcurrent Protection (A)	60	30
Starting Current (A)	144	144
Agency Approvals	UL/cUL Listed CE EAC Others available upon request	
Power Input Description	Terminal block	
ENCLOSURE PROTECTION		
UL Type	Type 12, 3R, 4 standard Type 4X Stainless steel optional	
International Rating	IP56 on the internal loop; IP34 on the external loop	
Description	Basic mechanical thermostat	
CONTROLLER		
Thermostat Location	Enclosure side on all base models	
Factory Thermostat Setting (°F/°C)	80/27	
SOUND LEVEL		
At 1.5 Meters	66 dB(A)	
UNIT CONSTRUCTION		
Material	Galvanized sheet metal standard Stainless steel optional	
Finish	RAL 7035 light-gray, semi-textured powder-coat paint standard	
UNIT DIMENSIONS		
Height (in./mm)	69.77/1772	
Width (in./mm)	35.86/911	
Depth (in./mm)	22.94/583	
Weight (lb./kg)	419/190.5	

Performance Curves for T70 Models 59000 BTU/Hr. (17287 Watt)

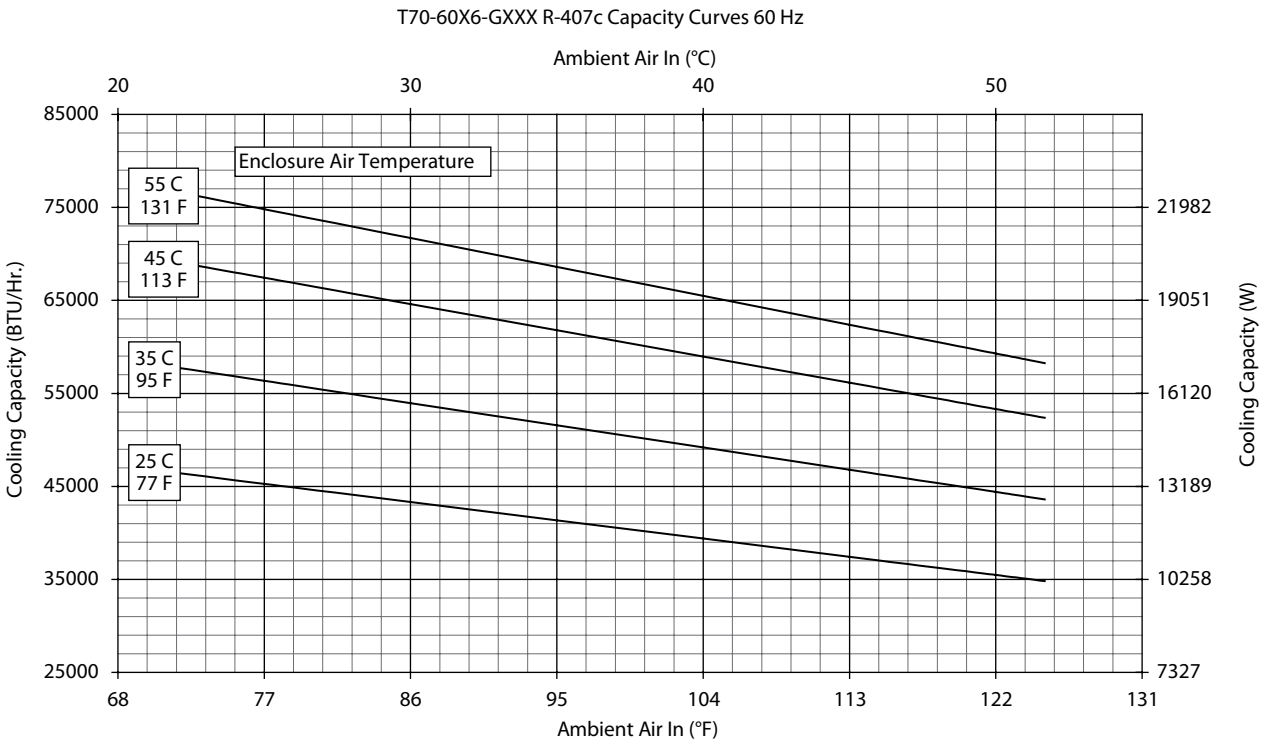
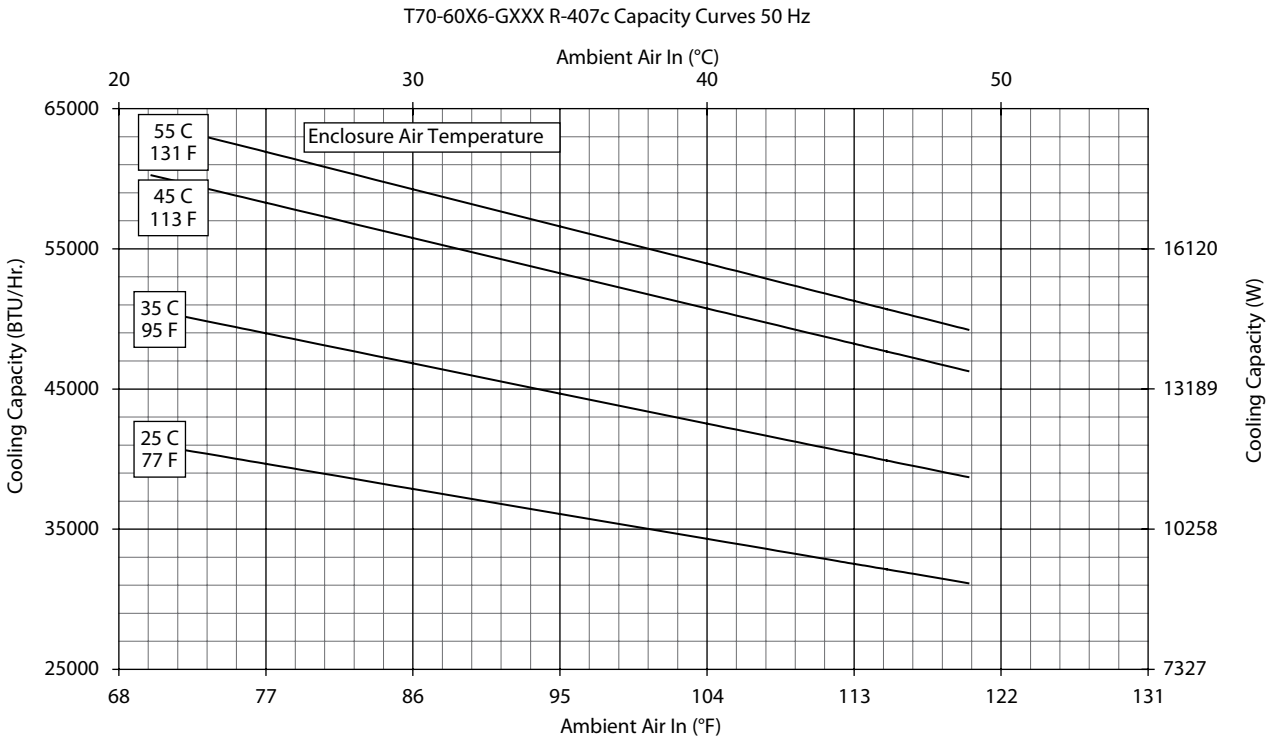

T70 Models 59000 BTU/Hr. (17287 Watt)

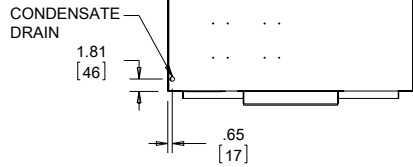
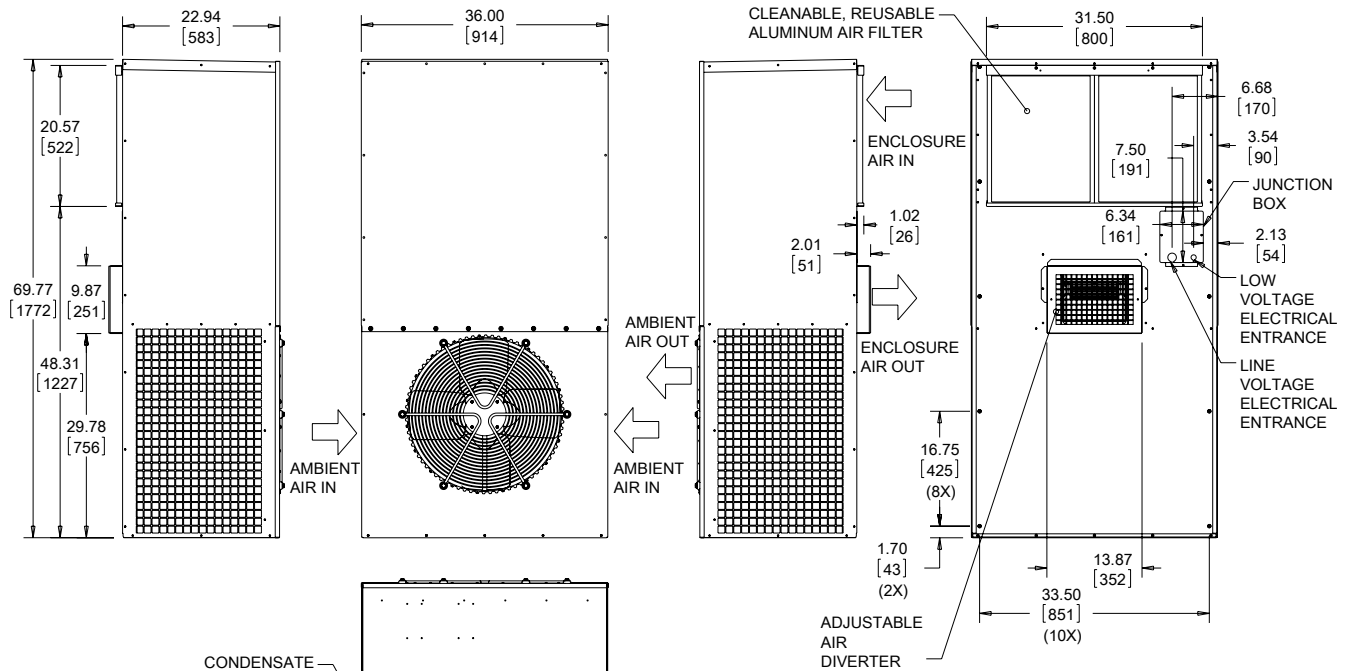

NOTE:
1. MOUNTING GASKET SUPPLIED (NOT SHOWN)
2. UNITS: in. [mm]

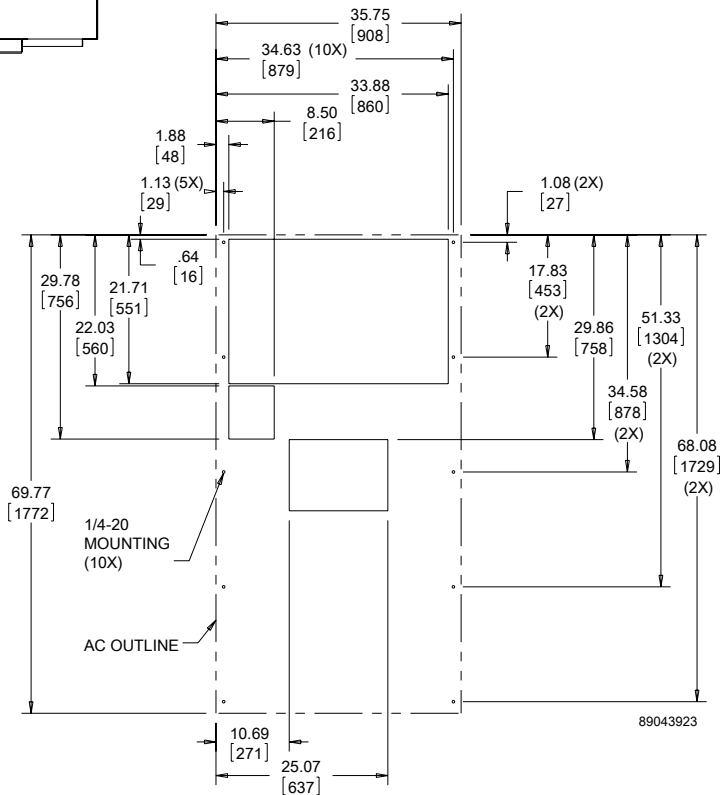

Cutout Dimensions

Visit www.nVent.com/HOFFMAN to download 2D and 3D CAD drawings into the overall design of your electrical system.