

FEED-THROUGH WIREWAY, NEMA TYPE 12

APPLICATION

With a variety of fittings and brackets, this traditional-design wireway is suitable for a broad range of industrial applications.

FEATURES

- Seams continuously welded and ground smooth
- No holes or knockouts
- Smooth, rounded edges on all sections and fittings
- Heavy butt hinges and external screw clamps
- Oil-resistant gasket and adhesive

SPECIFICATIONS

- 14 gauge steel covers and bodies
- 10 gauge steel end flanges

FINISH

ANSI 61 gray polyester powder finish inside and out over pretreated surfaces. Box connector is gray ANSI 61. Clamps and screws are plated.

INDUSTRY STANDARDS

UL 870; File No. E27524

NEMA/EEMAC Type 12
 JIC standards EGP-1-1967 and EMP-1-1967
 CSA, File No. 42184, Type 1
 IEC 60529, IP54

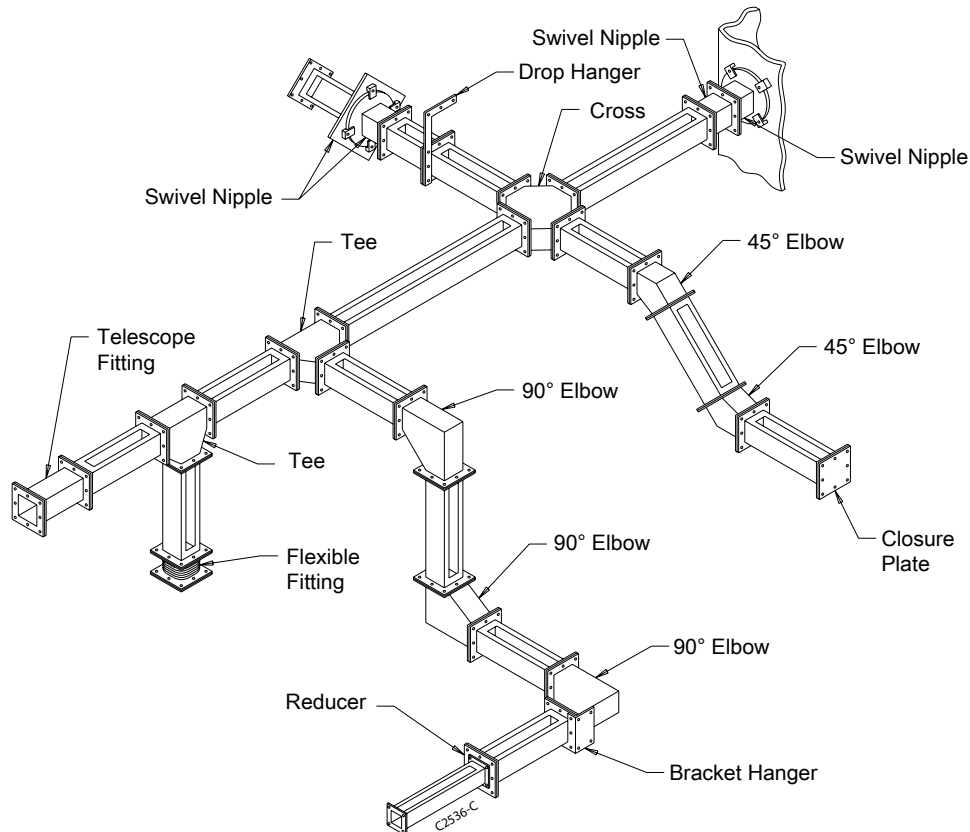

Standard Product Selection Matrix

| Description | 2.50 x 2.50 in. (64 x 64 mm) | 4.00 x 4.00 in. (102 x 102 mm) | 6.00 x 6.00 in. (152 x 152 mm) | 8.00 x 8.00 in. (203 x 203 mm) |
|--|---------------------------------|-----------------------------------|-----------------------------------|-----------------------------------|
| 12.00-in. (305-mm) Straight Section | F22W12 ^{c,d} | F44W12 ^{c,d} | F66W12 ^{c,d} | F88W12 ^{c,d} |
| 24.00-in. (610-mm) Straight Section | F22W24 ^{c,d} | F44W24 ^{c,d} | F66W24 ^{c,d} | F88W24 ^{c,d} |
| 36.00-in. (914-mm) Straight Section | F22W36 ^{c,d} | F44W36 ^{c,d} | F66W36 ^{c,d} | F88W36 ^{c,d} |
| 48.00-in. (1219-mm) Straight Section | F22W48 ^{c,d} | F44W48 ^{c,d} | F66W48 ^{c,d} | F88W48 ^{c,d} |
| 60.00-in. (1524-mm) Straight Section | F22W60 ^{c,d} | F44W60 ^{c,d} | F66W60 ^{c,d} | F88W60 ^{c,d} |
| 120.00-in. (3048-mm) Straight Section | F22W120 ^{c,d} | F44W120 ^{c,d} | F66W120 ^{c,d} | F88W120 ^{c,d} |
| 90° Elbow | F22WE90 ^{c,d} | F44WE90 ^{c,d} | F66WE90 ^{c,d} | F88WE90 ^{c,d} |
| 45° Elbow | F22WE45 ^{c,d} | F44WE45 ^{c,d} | F66WE45 ^{c,d} | F88WE45 ^{c,d} |
| 22.50° Elbow | F22WE225 ^{c,d} | F44WE225 ^{c,d} | F66WE225 ^{c,d} | F88WE225 ^{c,d} |
| Cross | F22WC ^{c,d} | F44WC ^{c,d} | F66WC ^{c,d} | F88WC ^{c,d} |
| Closure Plate | F22WP ^c | F44WP ^c | F66WP ^c | F88WP ^c |
| Tee | F22WT ^{c,d} | F44WT ^{c,d} | F66WT ^{c,d} | F88WT ^{c,d} |
| Telescope Fitting | F22WA | F44WA | F66WA | F88WA |
| Cutoff Fitting | F22WX | F44WX | F66WX | F88WX |
| Swivel Nipple (Box Entry) | F22WSA ^{c,d} | F44WSA ^{c,d} | F66WSA ^{c,d} | F88WSA ^{c,d} |
| Swivel Nipple (Regular) | F22WSC ^{c,d} | F44WSC ^{c,d} | F66WSC ^{c,d} | F88WSC ^{c,d} |
| 1.00-in. (25-mm) Nipple | F22WN1 ^{c,d} | F44WN1 ^{c,d} | F66WN1 ^{c,d} | F88WN1 ^{c,d} |
| 2.00-in. (51-mm) Nipple | F22WN2 ^{c,d} | F44WN2 ^{c,d} | F66WN2 ^{c,d} | F88WN2 ^{c,d} |
| 3.00-in. (76-mm) Nipple | F22WN3 ^{c,d} | F44WN3 ^{c,d} | F66WN3 ^{c,d} | F88WN3 ^{c,d} |
| 6.00-in. (152-mm) Nipple | F22WN6 ^{c,d} | F44WN6 ^{c,d} | F66WN6 ^{c,d} | F88WN6 ^{c,d} |
| Box Connector | F22WB | F44WB | F66WB | F88WB |
| Flexible Fitting | F22WFF | F44WFF | F66WFF | F88WFF |
| Reducer Bushings: 4.00-in. (102-mm) to 2.50-in. (64-mm) Center Hole | — | F44WR22 ^{c,d} | — | — |
| Reducer Bushings: 4.00-in. (102-mm) to 2.50-in. (64-mm) Edge Hole | — | F44WRE22 ^{c,d} | — | — |
| Reducer Bushings: 6.00-in. (152-mm) to 4.00-in. (102-mm) Center Hole | — | — | F66WR44 ^{c,d} | — |
| Reducer Bushings: 6.00-in. (152-mm) to 4.00-in. (102-mm) Edge Hole | — | — | F66WRE44 ^{c,d} | — |
| Reducer Bushings: 8.00-in. (203-mm) to 6.00-in. (152-mm) Center Hole | — | — | — | F88WR66 ^{c,d} |
| 8.00-in. (203-mm) to 6.00-in. (152-mm) Edge Hole | — | — | — | F88WRE66 ^{c,d} |
| Reducer Bushings: 8.00-in. (203-mm) to 4.00-in. (102-mm) Center Hole | — | — | — | F88WR44 ^{c,d} |
| Reducer Bushings: 8.00-in. (203-mm) to 4.00-in. (102-mm) Edge Hole | — | — | — | F88WRE44 ^{c,d} |
| Drop Hanger | F22HD | F44HD | F66HD | F88HD |
| Bracket Hanger | F22HB | F44HB | F66HB | F88HB |
| Barrier Kit, bolt on barrier 60.00 in. (1524 mm) | — | F44BK60 | F66BK60 | F88BK60 |
| Barrier, bracket mounted Each barrier 60.00 in. (1524 mm) ^a | — | F44B360 | F66B560 | — |
| Barrier Brackets, 2 compartment ^a | — | F44BB2C | F66BB2C | — |
| Barrier Brackets, 3 compartment ^a | — | F44BB3C | F66BB3C | — |
| Gasket and Screws ^b | F22WG | F44WG | F66WG | F88WG |

^a Package consists of five barriers or five barrier brackets. Each barrier is 60-in. long.

^b Standard packages of wireway contain one gasket and one set of screws to join sections, except "Cross" fittings which contain three of each, "Tee" fittings which contain two of each and Telescope fittings which contain none. Additional gasket and screw sets may be ordered by catalog number.

^c Certified by Canadian Standards Association.

^d UL 870

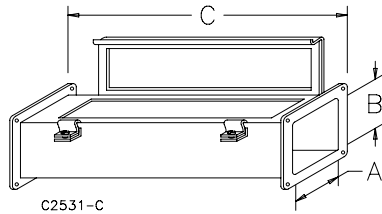
STRAIGHT SECTION

Available in lengths from 12.00 in. (305 mm) to 120.00 in. (3048 mm).

BULLETIN: F20

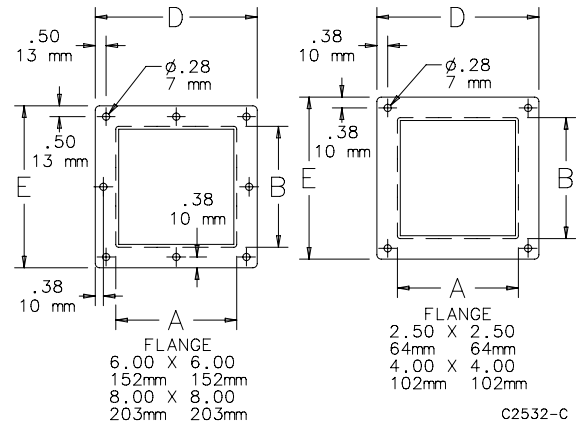
Straight Section

| Catalog Number | AxBxC in. | AxBxC mm | D (in.) | D (mm) | E (in.) | E (mm) |
|----------------|----------------------|------------------|---------|--------|---------|--------|
| F22W12 | 2.50 x 2.50 x 12.00 | 64 x 64 x 305 | 3.88 | 99 | 3.88 | 99 |
| F22W24 | 2.50 x 2.50 x 24.00 | 64 x 64 x 610 | 3.88 | 99 | 3.88 | 99 |
| F22W36 | 2.50 x 2.50 x 36.00 | 64 x 64 x 914 | 3.88 | 99 | 3.88 | 99 |
| F22W48 | 2.50 x 2.50 x 48.00 | 64 x 64 x 1219 | 3.88 | 99 | 3.88 | 99 |
| F22W60 | 2.50 x 2.50 x 60.00 | 64 x 64 x 1524 | 3.88 | 99 | 3.88 | 99 |
| F22W120 | 2.50 x 2.50 x 120.00 | 64 x 64 x 3048 | 3.88 | 99 | 3.88 | 99 |
| F44W12 | 4.00 x 4.00 x 12.00 | 102 x 102 x 305 | 5.38 | 137 | 5.38 | 137 |
| F44W24 | 4.00 x 4.00 x 24.00 | 102 x 102 x 610 | 5.38 | 137 | 5.38 | 137 |
| F44W36 | 4.00 x 4.00 x 36.00 | 102 x 102 x 914 | 5.38 | 137 | 5.38 | 137 |
| F44W48 | 4.00 x 4.00 x 48.00 | 102 x 102 x 1219 | 5.38 | 137 | 5.38 | 137 |
| F44W60 | 4.00 x 4.00 x 60.00 | 102 x 102 x 1524 | 5.38 | 137 | 5.38 | 137 |
| F44W120 | 4.00 x 4.00 x 120.00 | 102 x 102 x 3048 | 5.38 | 137 | 5.38 | 137 |
| F66W12 | 6.00 x 6.00 x 12.00 | 152 x 152 x 305 | 7.62 | 194 | 7.62 | 194 |
| F66W24 | 6.00 x 6.00 x 24.00 | 152 x 152 x 610 | 7.62 | 194 | 7.62 | 194 |
| F66W36 | 6.00 x 6.00 x 36.00 | 152 x 152 x 914 | 7.62 | 194 | 7.62 | 194 |
| F66W48 | 6.00 x 6.00 x 48.00 | 152 x 152 x 1219 | 7.62 | 194 | 7.62 | 194 |
| F66W60 | 6.00 x 6.00 x 60.00 | 152 x 152 x 1524 | 7.62 | 194 | 7.62 | 194 |
| F66W120 | 6.00 x 6.00 x 120.00 | 152 x 152 x 3048 | 7.62 | 194 | 7.62 | 194 |
| F88W12 | 8.00 x 8.00 x 12.00 | 203 x 203 x 305 | 9.62 | 244 | 9.62 | 244 |
| F88W24 | 8.00 x 8.00 x 24.00 | 203 x 203 x 610 | 9.62 | 244 | 9.62 | 244 |
| F88W36 | 8.00 x 8.00 x 36.00 | 203 x 203 x 914 | 9.62 | 244 | 9.62 | 244 |
| F88W48 | 8.00 x 8.00 x 48.00 | 203 x 203 x 1219 | 9.62 | 244 | 9.62 | 244 |
| F88W60 | 8.00 x 8.00 x 60.00 | 203 x 203 x 1524 | 9.62 | 244 | 9.62 | 244 |
| F88W120 | 8.00 x 8.00 x 120.00 | 203 x 203 x 3048 | 9.62 | 244 | 9.62 | 244 |

All dimensions are to outside surfaces. Allow .12 in. (3 mm) additional for gasket at joints.

Certified by Canadian Standards Association.

FLEXIBLE FITTING

Isolates a wireway run from shock and vibration. Compensates for misalignment. Used where an odd angle is required (but not to exceed 90 degrees). Permits movement of a machine or control station connected to a wireway run. Hypalon bellow with steel flanges.

BULLETIN: F20

| Catalog Number | AxB in./mm |
|----------------|--------------------------|
| F22WFF | 2.50 x 2.50 64 x 64 |
| F44WFF | 4.00 x 4.00 102 x 102 |
| F66WFF | 6.00 x 6.00 152 x 152 |
| F88WFF | 8.00 x 8.00 203 x 203 |

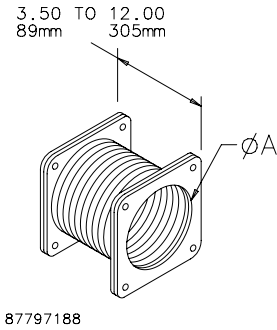

87797188

TELESCOPE FITTING

Length is easily adjustable from 1.50 in. (38 mm) to 13.50 in. (343 mm). No cutting or welding required.

BULLETIN: F20

| Catalog Number | AxB in./mm |
|----------------|--------------------------|
| F22WA | 2.50 x 2.50 64 x 64 |
| F44WA | 4.00 x 4.00 102 x 102 |
| F66WA | 6.00 x 6.00 152 x 152 |
| F88WA | 8.00 x 8.00 203 x 203 |

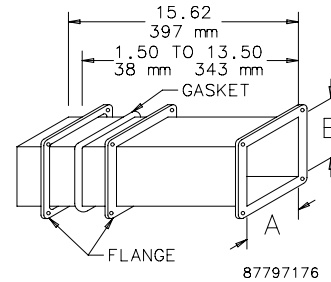

87797176

All dimensions are to outside surfaces. Allow .12 in. (3 mm) additional for gasket at joints.

CUT-OFF FITTING

For lengths up to 12.00 in. (305 mm). Shorten body to desired length and weld on flange.

BULLETIN: F20

| Catalog Number | AxB in./mm |
|----------------|--------------------------|
| F22WX | 2.50 x 2.50 64 x 64 |
| F44WX | 4.00 x 4.00 102 x 102 |
| F66WX | 6.00 x 6.00 152 x 152 |
| F88WX | 8.00 x 8.00 203 x 203 |

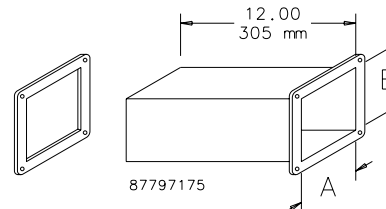

87797175

All dimensions are to outside surfaces. Allow .12 in. (3 mm) additional for gasket at joints.

CROSS

BULLETIN: F20

| Catalog Number | AxB in./mm | G in./mm | K in./mm |
|----------------|--------------------------|--------------|-------------|
| F22WC | 2.50 x 2.50 64 x 64 | 8.50 216 | 4.25 108 |
| F44WC | 4.00 x 4.00 102 x 102 | 10.00 254 | 5.00 127 |
| F66WC | 6.00 x 6.00 152 x 152 | 12.00 305 | 6.00 152 |
| F88WC | 8.00 x 8.00 203 x 203 | 14.00 356 | 7.00 178 |

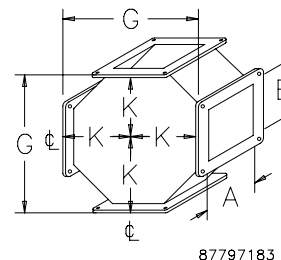

87797183

All dimensions are to outside surfaces. Allow .12 in. (3 mm) additional for gasket at joints. Dimension K are from intersection of center lines.

Certified by Canadian Standards Association.

22.50-DEGREE ELBOW

BULLETIN: F20

| Catalog Number | AxB in./mm | H in./mm |
|----------------|--------------------------|-------------|
| F22WE225 | 2.50 x 2.50 64 x 64 | 3.26 83 |
| F44WE225 | 4.00 x 4.00 102 x 102 | 4.13 105 |
| F66WE225 | 6.00 x 6.00 152 x 152 | 5.15 131 |
| F88WE225 | 8.00 x 8.00 203 x 203 | 6.35 161 |

All dimensions are to outside surfaces. Allow .12 in. (3 mm) additional for gasket at joints.

Certified by Canadian Standards Association.

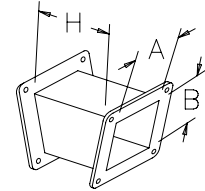

87797177

45-DEGREE ELBOW

BULLETIN: F20

| Catalog Number | AxB in./mm | H in./mm | J in./mm |
|----------------|--------------------------|-------------|------------|
| F22WE45 | 2.50 x 2.50 64 x 64 | 2.50 64 | 2.00 51 |
| F44WE45 | 4.00 x 4.00 102 x 102 | 3.25 83 | 2.44 62 |
| F66WE45 | 6.00 x 6.00 152 x 152 | 4.25 108 | 3.00 76 |
| F88WE45 | 8.00 x 8.00 203 x 203 | 5.25 133 | 3.62 92 |

All dimensions are to outside surfaces. Allow .12 in. (3 mm) additional for gasket at joints. Dimension J is from intersection of center lines.

Certified by Canadian Standards Association.

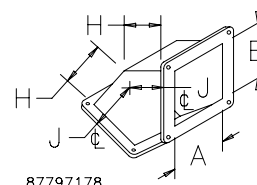

87797178

90-DEGREE ELBOW

BULLETIN: F20

| Catalog Number | AxB in./mm | F in./mm | K in./mm |
|----------------|--------------------------|--------------|-------------|
| F22WE90 | 2.50 x 2.50 64 x 64 | 5.50 140 | 4.25 108 |
| F44WE90 | 4.00 x 4.00 102 x 102 | 7.00 178 | 5.00 127 |
| F66WE90 | 6.00 x 6.00 152 x 152 | 9.00 229 | 6.00 152 |
| F88WE90 | 8.00 x 8.00 203 x 203 | 11.00 279 | 7.00 178 |

All dimensions are to outside surfaces. Allow .12 in. (3 mm) additional for gasket at joints. Dimension K is from intersection of center lines.

Certified by Canadian Standards Association.

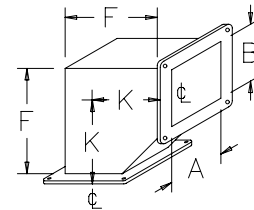

87797206

TEE

BULLETIN: F20

| Catalog Number | AxB in./mm | F in./mm | G in./mm | K in./mm |
|----------------|--------------------------|--------------|--------------|-------------|
| F22WT | 2.50 x 2.50 64 x 64 | 5.50 140 | 8.50 216 | 4.25 108 |
| F44WT | 4.00 x 4.00 102 x 102 | 7.00 178 | 10.00 254 | 5.00 127 |
| F66WT | 6.00 x 6.00 152 x 152 | 9.00 229 | 12.00 305 | 6.00 152 |
| F88WT | 8.00 x 8.00 203 x 203 | 11.00 279 | 14.00 356 | 7.00 178 |

All dimensions are to outside surfaces. Allow .12 in. (3 mm) additional for gasket at joints. Dimension K is from intersection of center lines.

Certified by Canadian Standards Association.

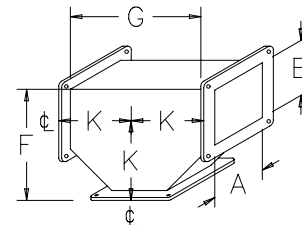

87797182

CLOSURE PLATE

Used to seal the end on a wireway section or run.

BULLETIN: F20

| Catalog Number | D in./mm | E in./mm |
|----------------|-------------|-------------|
| F22WP | 3.88 99 | 3.88 99 |
| F44WP | 5.38 137 | 5.38 137 |
| F66WP | 7.62 194 | 7.62 194 |
| F88WP | 9.62 244 | 9.62 244 |

All dimensions are to outside surfaces. Allow .12 in. (3 mm) additional for gasket at joints.
 Certified by Canadian Standards Association.

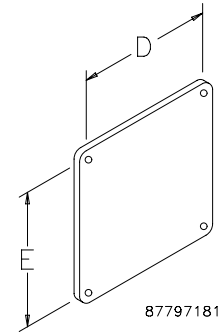

REDUCER BUSHINGS

Used to reduce to a smaller wireway size. The center hole bushing centers the two wireway sizes relative to each other while the edge hole bushing keeps the top surfaces even.

BULLETIN: F20

Center Hole

| Catalog Number | AxB in. | AxB mm | D (in.) | D (mm) | E (in.) | E (mm) |
|----------------|-------------|-----------|---------|--------|---------|--------|
| F44WR22 | 2.00 x 2.00 | 51 x 51 | 5.38 | 137 | 5.38 | 137 |
| F66WR44 | 4.00 x 4.00 | 102 x 102 | 7.62 | 194 | 7.62 | 194 |
| F88WR44 | 4.00 x 4.00 | 102 x 102 | 9.62 | 244 | 9.62 | 244 |
| F88WR66 | 6.00 x 6.00 | 152 x 152 | 9.62 | 244 | 9.62 | 244 |

All dimensions are to outside surfaces. Allow .12 in. (3 mm) additional for gasket at joints.
 Certified by Canadian Standards Association.

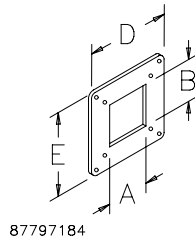

Edge Hole

| Catalog Number | AxB in. | AxB mm | D (in.) | D (mm) | E (in.) | E (mm) |
|----------------|-------------|-----------|---------|--------|---------|--------|
| F44WRE22 | 2.00 x 2.00 | 51 x 51 | 5.38 | 137 | 5.38 | 137 |
| F66WRE44 | 4.00 x 4.00 | 102 x 102 | 7.62 | 194 | 7.62 | 194 |
| F88WRE44 | 4.00 x 4.00 | 102 x 102 | 9.62 | 244 | 9.62 | 244 |
| F88WRE66 | 6.00 x 6.00 | 152 x 152 | 9.62 | 244 | 9.62 | 244 |

All dimensions are to outside surfaces. Allow .12 in. (3 mm) additional for gasket at joints.
 Certified by Canadian Standards Association.

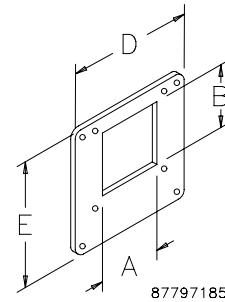

NIPPLE

BULLETIN: F20

| Catalog Number | AxBxC in. | AxBxC mm |
|----------------|--------------------|-----------------|
| F22WN1 | 2.50 x 2.50 x 1.00 | 64 x 64 x 25 |
| F22WN2 | 2.50 x 2.50 x 2.00 | 64 x 64 x 51 |
| F22WN3 | 2.50 x 2.50 x 3.00 | 64 x 64 x 76 |
| F22WN6 | 2.50 x 2.50 x 6.00 | 64 x 64 x 152 |
| F44WN1 | 4.00 x 4.00 x 1.00 | 102 x 102 x 25 |
| F44WN2 | 4.00 x 4.00 x 2.00 | 102 x 102 x 51 |
| F44WN3 | 4.00 x 4.00 x 3.00 | 102 x 102 x 76 |
| F44WN6 | 4.00 x 4.00 x 6.00 | 102 x 102 x 152 |
| F66WN1 | 6.00 x 6.00 x 1.00 | 152 x 152 x 25 |
| F66WN2 | 6.00 x 6.00 x 2.00 | 152 x 152 x 51 |
| F66WN3 | 6.00 x 6.00 x 3.00 | 152 x 152 x 76 |
| F66WN6 | 6.00 x 6.00 x 6.00 | 152 x 152 x 152 |
| F88WN1 | 8.00 x 8.00 x 1.00 | 203 x 203 x 25 |
| F88WN2 | 8.00 x 8.00 x 2.00 | 203 x 203 x 51 |
| F88WN3 | 8.00 x 8.00 x 3.00 | 203 x 203 x 76 |
| F88WN6 | 8.00 x 8.00 x 6.00 | 203 x 203 x 152 |

Certified by Canadian Standards Association.

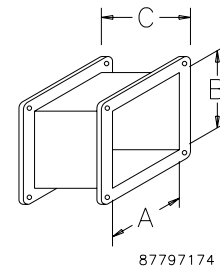

SWIVEL NIPPLES

Allows wireway run to be adjusted to any angle. Regular type is used between adjacent wireway sections or fittings while the box entry type is used when entering an enclosure.

BULLETIN: F20

Regular

| Catalog Number | AxB in. | AxB mm |
|----------------|-------------|-----------|
| F22WSC | 2.50 x 2.50 | 64 x 64 |
| F44WSC | 4.00 x 4.00 | 102 x 102 |
| F66WSC | 6.00 x 6.00 | 152 x 152 |
| F88WSC | 8.00 x 8.00 | 203 x 203 |

All dimensions are to outside surfaces. Allow .12 in. (3 mm) additional for gasket at joints.

Certified by Canadian Standards Association.

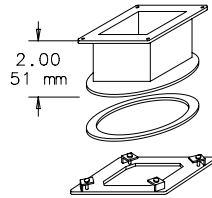

87797186

HANGERS

Hangers are used to support a wireway run. The drop hanger is normally attached to an overhead beam or ceiling while the bracket hanger can be used for wall, floor or ceiling installations.

BULLETIN: F20

Drop Hanger

| Catalog Number | S (in.) | S (mm) | T (in.) | T (mm) |
|----------------|---------|--------|---------|--------|
| F22HD | 9.25 | 235 | 4.50 | 114 |
| F44HD | 11.75 | 298 | 6.00 | 152 |
| F66HD | 15.25 | 387 | 8.12 | 206 |
| F88HD | 20.56 | 522 | 12.12 | 308 |

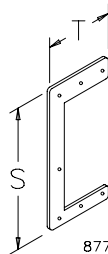

87797192

BOX CONNECTOR

When wireway enters an enclosure, a box connector should be used on the inside of the enclosure to ensure a tight and stable seal.

BULLETIN: F20

| Catalog Number | D in./mm | E in./mm |
|----------------|-------------|-------------|
| F22WB | 3.88 99 | 3.88 99 |
| F44WB | 5.38 137 | 5.38 137 |
| F66WB | 7.62 194 | 7.62 194 |
| F88WB | 9.62 244 | 9.62 244 |

All dimensions are to outside surfaces. Allow .12 in. (3 mm) additional for gasket at joints.

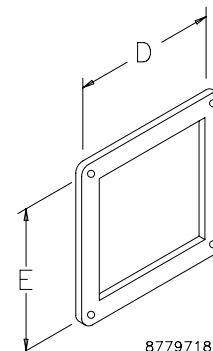

87797180

Box Entry

| Catalog Number | AxB in. | AxB mm |
|----------------|-------------|-----------|
| F22WSA | 2.50 x 2.50 | 64 x 64 |
| F44WSA | 4.00 x 4.00 | 102 x 102 |
| F66WSA | 6.00 x 6.00 | 152 x 152 |
| F88WSA | 8.00 x 8.00 | 203 x 203 |

All dimensions are to outside surfaces. Allow .12 in. (3 mm) additional for gasket at joints.

Certified by Canadian Standards Association.

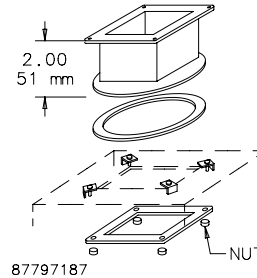

87797187

Bracket Hanger

| Catalog Number | P (in.) | P (mm) | R (in.) | R (mm) | U (in.) | U (mm) |
|----------------|---------|--------|---------|--------|---------|--------|
| F22HB | 4.62 | 117 | 3.62 | 92 | 4.38 | 111 |
| F44HB | 6.12 | 155 | 3.62 | 92 | 5.88 | 149 |
| F66HB | 8.25 | 210 | 3.62 | 92 | 7.88 | 200 |
| F88HB | 10.25 | 260 | 3.62 | 92 | 11.25 | 286 |

All dimensions are to outside surfaces. Allow .12 in. (3 mm) additional for gasket at joints.

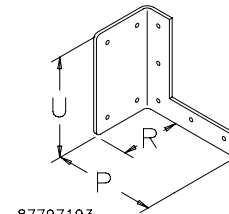

87797193

BARRIER KITS

Divides wireway into two or three compartments. Plated spring steel brackets hold barriers in place by friction fit inside wireway. Order barrier and bracket separately. Recommended spacing increments of 3 ft.

W = 3.00 in. (76 mm) for 4.00 x 4.00 in. (102 x 102 mm)
 W = 4.50 in. (114 mm) for 6.00 x 6.00 in. (152 x 152 mm)

BULLETIN: F10, F20

Compartment Barriers

| Catalog Number | W (in.) | W (mm) |
|----------------|---------|--------|
| F44B360 | 3.00 | 76 |
| F66B560 | 4.50 | 114 |

All dimensions are to outside surfaces. Allow .12 in. (3 mm) additional for gasket at joints.

Package consists of five barriers

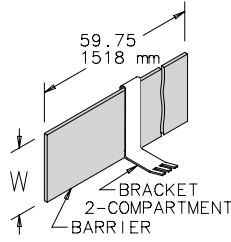

89159486

Two-Compartment Brackets

| Catalog Number | W (in.) | W (mm) |
|----------------|---------|--------|
| F44BB2C | 3.00 | 76 |
| F66BB2C | 4.50 | 114 |

All dimensions are to outside surfaces. Allow .12 in. (3 mm) additional for gasket at joints.

Package consists of five barrier brackets.

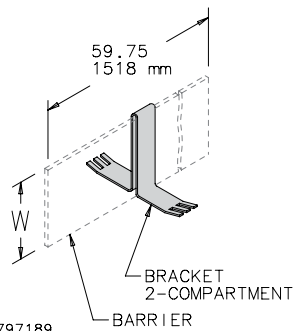

87797189

GASKET AND SCREWS

Standard packages of wireway contain one gasket and one set of screws to join sections, except Cross Fittings which contain three of each, Tee Fittings which contain two of each and Telescope Fittings which contain none. Additional gasket and screw sets may be ordered by catalog number.

BULLETIN: F20

Three-Compartment Brackets

| Catalog Number | W (in.) | W (mm) |
|----------------|---------|--------|
| F44BB3C | 3.00 | 76 |
| F66BB3C | 4.50 | 114 |

All dimensions are to outside surfaces. Allow .12 in. (3 mm) additional for gasket at joints.

Package consists of five barrier brackets.

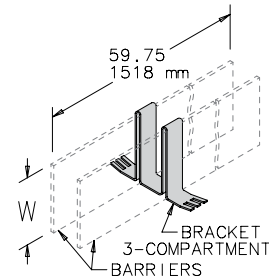

87797190

Bolt-On Barriers

| Catalog Number | W (in.) | W (mm) |
|----------------|---------|--------|
| F33BK60 | 2.00 | 51 |
| F44BK60 | 3.00 | 76 |
| F66BK60 | 4.50 | 114 |
| F88BK60 | 6.00 | 152 |

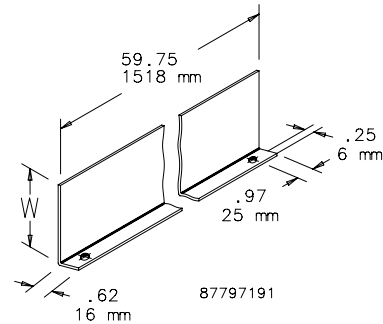

87797191

| Catalog Number | AxB in./mm |
|----------------|--------------------------|
| F22WG | 2.50 x 2.50 64 x 64 |
| F44WG | 4.00 x 4.00 102 x 102 |
| F66WG | 6.00 x 6.00 152 x 152 |
| F88WG | 8.00 x 8.00 203 x 203 |