

LAY-IN WIREWAY, NEMA TYPE 3R

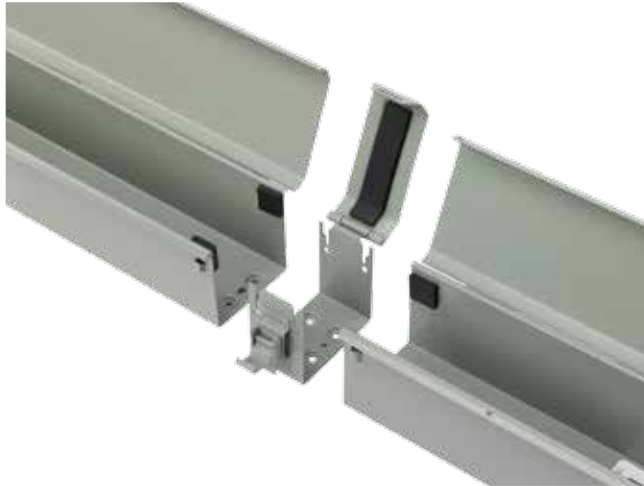

INDUSTRY STANDARDS

UL 870 Listed; File No. E27524; Raintight
 NEMA/EEMAC Type 3R
 CSA File No. 42184, Type 3R
 IEC 60529, IP32

APPLICATION

This moistureproof wireway features a quick-release latch cover for convenient access and an opening on one side so wires and cables can be laid in along the entire run without pulling.

FEATURES

- Open top assembly
- Self-connecting system
- Removable covers with quick-release latches

SPECIFICATIONS

- 16 or 14 gauge galvanized steel

FINISH

ANSI 61 gray polyester powder paint finish inside and out over pretreated surfaces.

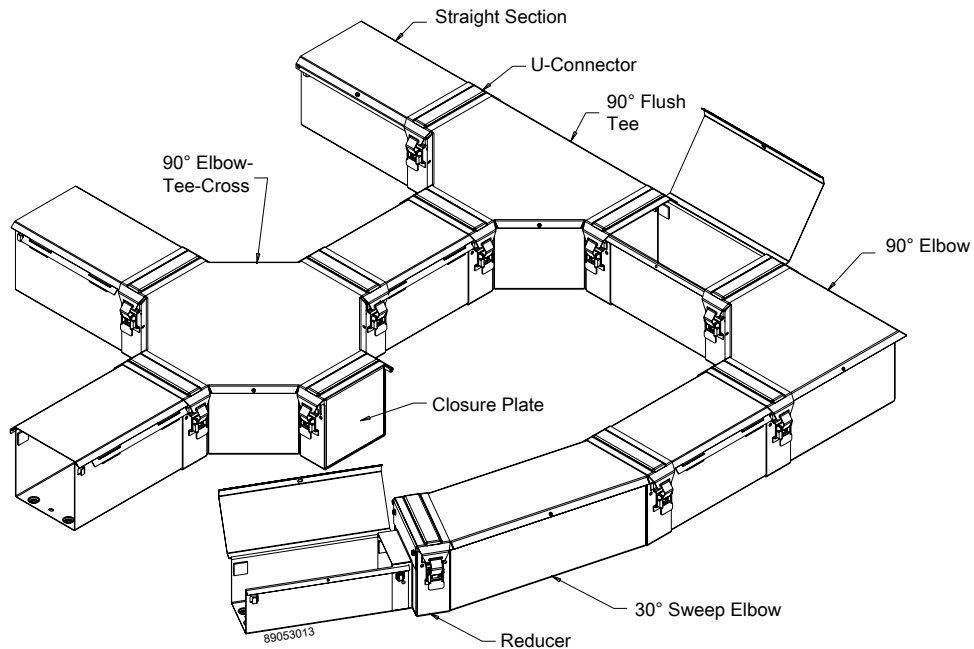

Standard Product Selection Matrix

Description	4.00 x 4.00 in. (102 x 102 mm)	6.00 x 6.00 in. (152 x 152 mm)	8.00 x 8.00 in. (203 x 203 mm)
12.00-in. (305-mm) Straight Section ^a	F44T3R12	F66T3R12	F88T3R12
60.00-in. (1524-mm) Straight Section ^a	F44T3R60	F66T3R60	F88T3R60
120.00-in. (3048-mm) Straight Section ^a	F44T3R120	F66T3R120	F88T3R120
90° Flush Tee	F44T3RT	F66T3RT	F88T3RT
30° Sweep Elbow	F44T3R30SE	F66T3R30SE	F88T3R30SE
90° Elbow-Tee-Cross	F44T3RTX	F66T3RTX	F88T3RTX
90° Elbow	F44T3R90E	F66T3R90E	F88T3R90E
Panel Adapter	F44T3RPA	F66T3RPA	F88T3RPA
Closure Plate	F44T3RCP	F66T3RCP	F88T3RCP
Reducer	—	F66T3R44R	F88T3R66R
Drop and Bracket Hanger	F44T3RDH	F66T3RDH	F88T3RDH
Wall Hanger	F44T3RWH	F66T3RWH	F88T3RWH
Universal U-Connector	F44T3RUC	F66T3RUC	F88T3RUC

STRAIGHT SECTION

Available in lengths from 12 in. (305 mm) to 120 in. (3038 mm).

BULLETIN: F30G

Catalog Number	AxBxC in.	AxBxC mm
F44T3R12	4.00 x 4.00 x 12.00	102 x 102 x 305
F44T3R60	4.00 x 4.00 x 60.00	102 x 102 x 1524
F44T3R120	4.00 x 4.00 x 120.00	102 x 102 x 3048
F66T3R12	6.00 x 6.00 x 12.00	152 x 152 x 305
F66T3R60	6.00 x 6.00 x 60.00	152 x 152 x 1524
F66T3R120	6.00 x 6.00 x 120.00	152 x 152 x 3048
F88T3R12	8.00 x 8.00 x 12.00	203 x 203 x 305
F88T3R60	8.00 x 8.00 x 60.00	203 x 203 x 1524
F88T3R120	8.00 x 8.00 x 120.00	203 x 203 x 3048

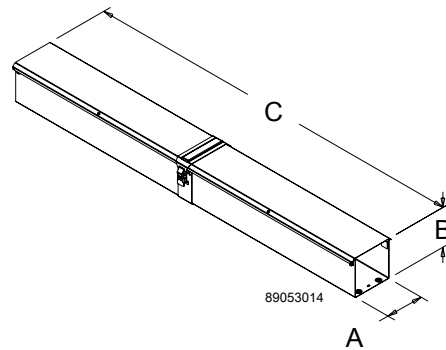

90-DEGREE FLUSH TEE

Use whenever flush mounting against a vertical surface is required.

BULLETIN: F30G

Catalog Number	AxB in./mm	O in./mm
F44T3RT	4.00 x 4.00	16.00
	102 x 102	406
F66T3RT	6.00 x 6.00	18.00
	152 x 152	457
F88T3RT	8.00 x 8.00	20.00
	203 x 203	508

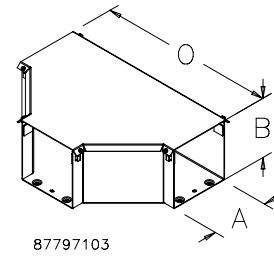

30-DEGREE SWEEP ELBOW

When a large radius is needed, use this sweep elbow.

BULLETIN: F30G

Catalog Number	AxB in./mm	N in./mm	U in./mm
F44T3R30SE	4.00 x 4.00	13.00	1.25
	102 x 102	330	31
F66T3R30SE	6.00 x 6.00	13.00	1.25
	152 x 152	330	31
F88T3R30SE	8.00 x 8.00	13.00	1.25
	203 x 203	330	31

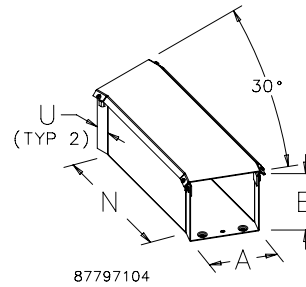

90-DEGREE CROSS

Use when there are four branches. It can be used as a 90-degree elbow or a 90-degree flush tee by adding Closure Plates.

BULLETIN: F30G

Catalog Number	AxB in./mm	G in./mm
F44T3RTX	4.00 x 4.00	16.00
	102 x 102	406
F66T3RTX	6.00 x 6.00	18.00
	152 x 152	457
F88T3RTX	8.00 x 8.00	20.00
	203 x 203	508

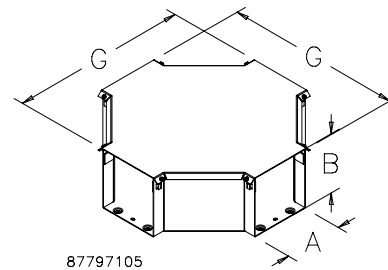

90-DEGREE ELBOW

Used whenever a right-angle installation is needed.

BULLETIN: F30G

Catalog Number	AxB in./mm	Q in./mm
F44T3R90E	4.00 x 4.00 102 x 102	10.00 254
F66T3R90E	6.00 x 6.00 152 x 152	12.00 305
F88T3R90E	8.00 x 8.00 203 x 203	14.00 356

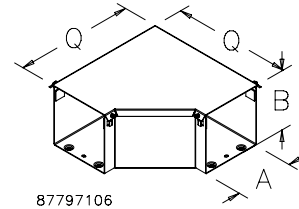

PANEL ADAPTER

Allows the wireway to be securely connected to an enclosure.

BULLETIN: F30G

Catalog Number	AxB in./mm
F44T3RPA	4.00 x 4.00 102 x 102
F66T3RPA	6.00 x 6.00 152 x 152
F88T3RPA	8.00 x 8.00 203 x 203

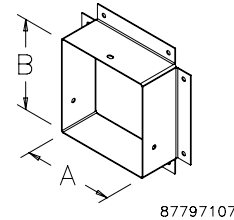

CLOSURE PLATE

Closes the end of a wireway section or run. A U-connector must be used in combination with a closure plate to close the end of a wireway section or run.

BULLETIN: F30G

Catalog Number	AxB in./mm
F44T3RCP	4.00 x 4.00 102 x 102
F66T3RCP	6.00 x 6.00 152 x 152
F88T3RCP	8.00 x 8.00 203 x 203

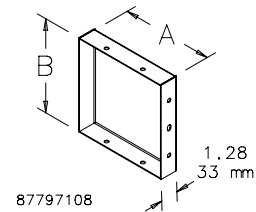

REDUCER

Used to reduce to a smaller wireway size.

BULLETIN: F30G

Catalog Number	AxB in./mm
F66T3R44R	6.00 x 6.00 152 x 152
F88T3R66R	8.00 x 8.00 203 x 203

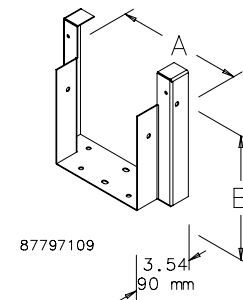

DROP AND BRACKET HANGER

Used to support a wireway run.

BULLETIN: F30G

Catalog Number	AxB in./mm	S in./mm	T in./mm
F44T3RDH	4.00 x 4.00 102 x 102	9.50 241	4.50 114
F66T3RDH	6.00 x 6.00 152 x 152	14.00 356	5.50 140
F88T3RDH	8.00 x 8.00 203 x 203	14.00 356	8.00 203

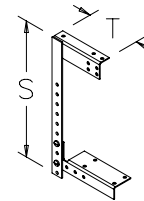

87797111

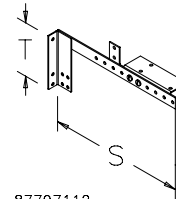

87797112

WALL HANGER

Used to support a wireway run.

BULLETIN: F30G

Catalog Number	V in./mm	W in./mm
F44T3RWH	5.00 127	5.00 127
F66T3RWH	7.00 178	7.00 178
F88T3RWH	9.00 229	9.00 229

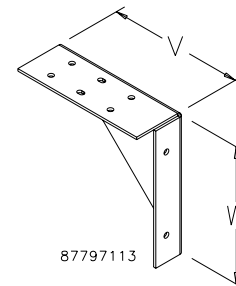

87797113

U-CONNECTOR

Used to rigidly join fittings to straight sections.

BULLETIN: F30G

Catalog Number	AxB in./mm
F44T3RUC	4.00 x 4.00 102 x 102
F66T3RUC	6.00 x 6.00 152 x 152
F88T3RUC	8.00 x 8.00 203 x 203

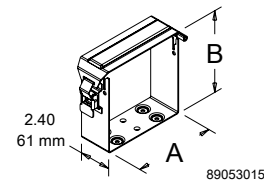

89053015