

DATA SHEET

ARUBA OUTDOOR 4X4 MIMO ANTENNA

JW018A

AP-ANT-45 is a multi-polarized antenna with nominal 90° H x 90° V beamwidths. This antenna is well suited for 2.4 and 5 GHz sector coverage for access.

FREQUENCY/GAIN

- 4.9-6.0 GHz/5.5 dBi
- 2.4-2.5 GHz/4.5 dBi

DIMENSIONS

- 200 mm x 200 mm x 40 mm

POLARIZATION

- +/-45° +/-135°

WEIGHT

- 590 g

BEAMWIDTH

- Horiz Plane: 90° Vert Plane: 90° @ 2.4 GHz
- Horiz Plane: 90° Vert Plane: 90° @ 5.x GHz

HOUSING

- Housing: Aluminum
- Radome: Plastic

IMPEDANCE

- 50 ohms

CONNECTION

- 75 cm RPSMA terminated pigtailed

MAXIMUM INPUT POWER

- 6 watts

OPERATING TEMPERATURE

- -40° C to +65° C



VSWR

- 2:1 max

INSTALLATION HARDWARE

- Wall mount anchors provided
- Optional AP-ANT-MNT-5 bracket purchased separately

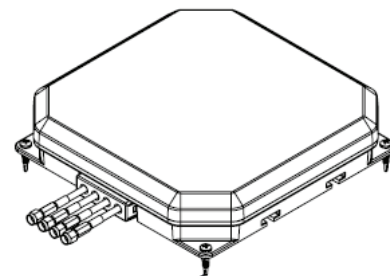

Wall mount

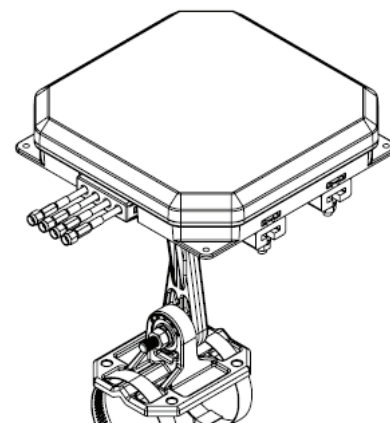

With Pole Mount Kit (AP-ANT-MNT-5)

ANTENNA PATTERN PLOTS

Vertical patterns

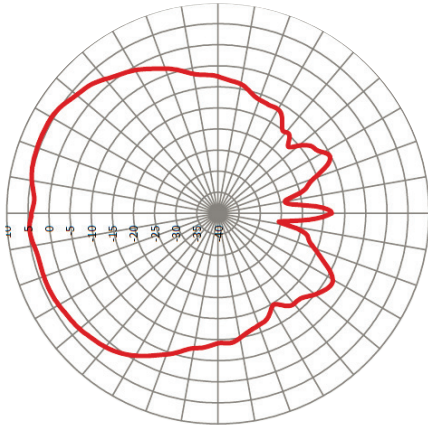

5.x GHz

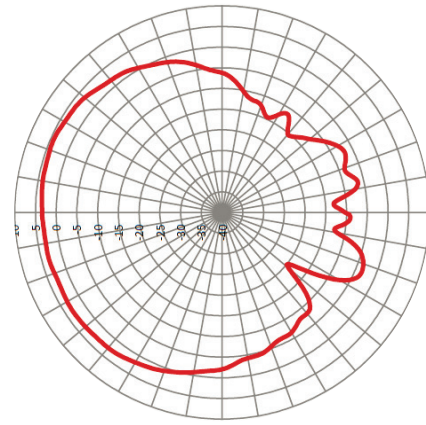

2.4 GHz

Horizontal patterns

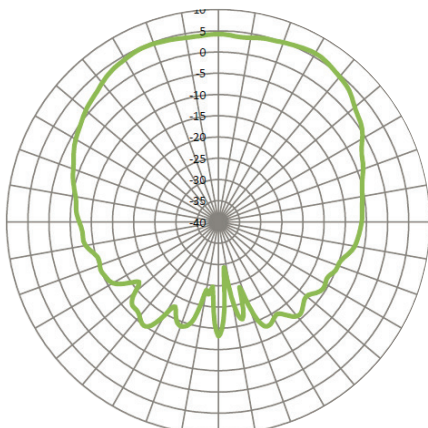

5.x GHz

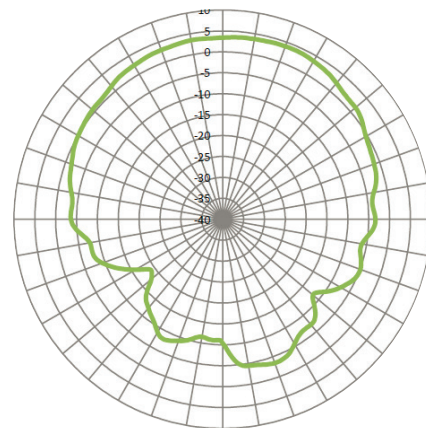

2.4 GHz

ORDERING INFORMATION

Part Number	Description
JW018A	AP-ANT-45 Dual Band 90x90deg 5dBi 4 Element MIMO 4xRPSMA Pigtail Antenna
JW022A	AP-ANT-MNT-5 AP-ANT-45 Azimuth and Elevation Adjustable Mount Kit