



DuroSite® LED Linear Fixture - UL / CSA
for Indoor and Outdoor Industrial Applications





DuroSite® LED Linear Fixture

Low profile

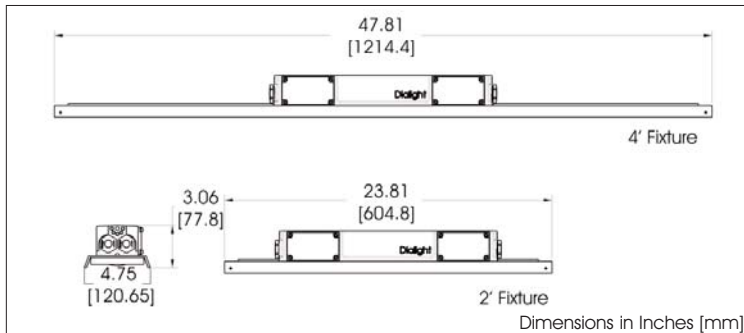

Certifications & Ratings

- UL 1598/A
- UL 8750
- CSA 22.2 No.250.0
- IP 66/67
- NEMA 4X

Features & Benefits

- 5 year full performance warranty
- L70 rated for > 100,000 hours @ 25°C
- DLC Listed (80 CRI CW & NW models only)
- Instant on/off operation
- Resistant to water, salt, dust & vibration
- Resistant up to 20 PSI of hose directed water
- Universal input (100-277V AC), 50/60Hz
- Mercury free
- Temperature compensation technology for longer life
- Factory sealed
- Integrated wiring box
- Low profile housing for limited space applications
- Dual NPT entries for in / out wiring
- Thru wiring capability

Application

Dialight's DuroSite® LED linear fixture replaces HID and fluorescent lighting fixtures in industrial applications. The DuroSite® LED Linear fixture's rugged solid state design makes it highly resistant to shock and vibration. Its fully gasketed IP 66 rated enclosure makes it suitable for dusty & wet locations, its 1598/A rating guarantees added protection from salt water spray. The DuroSite® LED Linear's superior design allows for wiring and mounting versatility and ease of installation for many lighting applications.

Mechanical Information

Fixture Weight:	10 lbs (4.50 kg) 4'
	7 lbs (3.13 kg) 2'
Shipping Weight:	11 lbs (4.90 kg) 4'
	8 lbs (3.64 kg) 2'
Mounting:	(4) 3/4" NPT openings Optional swivel bracket - LPXW4 Optional low profile bracket - LPXW4LP

Electrical Specifications

Operating Voltage:	100 - 277V AC 50/60Hz
Power Consumption:	See ordering information
Operating Temp:	-40°F to +149°F (-40°C to +65°C)
Harmonics:	IEC 61000-3-2
Noise Requirements/ EMC:	FCC Title 47, Subpart B, Section 15, class A device. RF Immunity; 10V/m, 80MHz-1GHz
Surge Protection:	EN 61000-4-5 4 kV line to line 4 kV line to ground
THD:	< 20%
Power Factor:	> 0.9

Power supply equipped with inline fuse

Construction

Body:	Powder coated aluminum
Lens:	Polycarbonate

Photometric Information

CRI:	75 , 80
CCT:	5000K (cool white) 4000K (neutral white)
IES Files:	Available upon request

All values typical unless otherwise stated
All lumen values are typical (tolerance +/- 10%)

Mounting Options

LPXW4LP



Side Mount - LPXW4



Top Mount - LPXW4





DuroSite® LED Linear Fixture Top Conduit Mounting

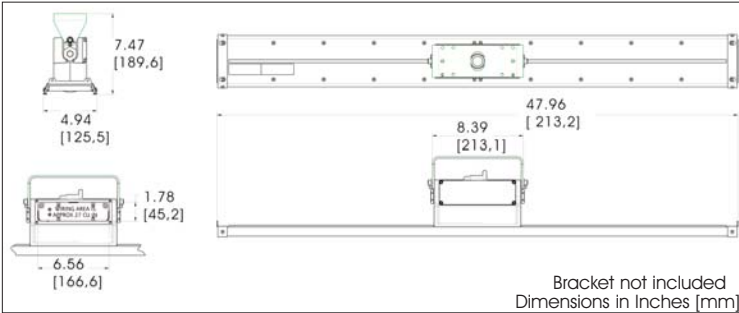

Certifications & Ratings

- UL 1598/A
- UL 8750
- CSA 22.2 No.250.0
- IP 66
- NEMA 4X

Features & Benefits

- 5 year full performance warranty
- L70 rated for > 100,000 hours @ 25°C
- Instant on/off operation
- Resistant to water, salt, dust & vibration
- Resistant up to 20 PSI of hose directed water
- Universal input (100-277V AC), 50/60Hz
- Mercury free
- Temperature compensation technology for longer life
- Factory sealed
- Integrated wiring box

Application

Dialight's DuroSite® LED linear fixture replaces HID and fluorescent lighting fixtures in industrial applications. The DuroSite® LED Linear fixture's rugged solid state design makes it highly resistant to shock and vibration. Its fully gasketed IP 66 rated enclosure makes it suitable for dusty & wet locations, its 1598/A rating guarantees added protection from salt water spray. The DuroSite® LED Linear's superior design allows for mounting versatility and ease of installation for many lighting applications.

Mechanical Information

Fixture Weight:	11 lbs (4.99 kg) 4' 10 lbs (4.53 kg) 2'
Shipping Weight:	13 lbs (5.90 kg) 4' 12 lbs (5.44 kg) 2'
Mounting:	(3) 3/4" NPT openings Optional swivel bracket - LTXW4 Optional low profile bracket - LTXW4LP

Electrical Specifications

Operating Voltage:	100 - 277V AC 50/60Hz
Power Consumption:	See ordering information
Operating Temp:	-40°F to +149°F (-40°C to +65°C)
Harmonics:	IEC 61000-3-2
Noise Requirements/ EMC:	FCC Title 47, Subpart B, Section 15, class A device. RF Immunity; 10V/m, 80MHz-1GHz
Surge Protection:	EN 61000-4-5 4 kV line to line 4 kV line to ground

THD: < 20%

Power Factor: > 0.9

Power supply equipped with inline fuse

Construction

Body:	Powder coated aluminum
Lens:	Polycarbonate

Photometric Information

CRI:	75, 80
CCT:	5000K (cool white) 4000K (neutral white)
IES Files:	Available upon request

All values typical unless otherwise stated
All lumen values are typical (tolerance +/- 10%)
*Consult factory for 80 min CRI

Mounting Options

Conduit Top Mount

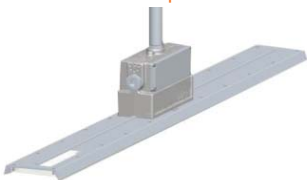

Conduit Side Mount



LTXW4



LTXW4LP

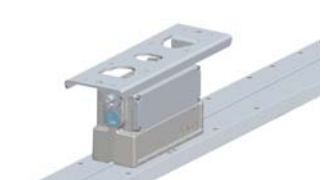



DuroSite® LED Linear Fixture

Battery Backup

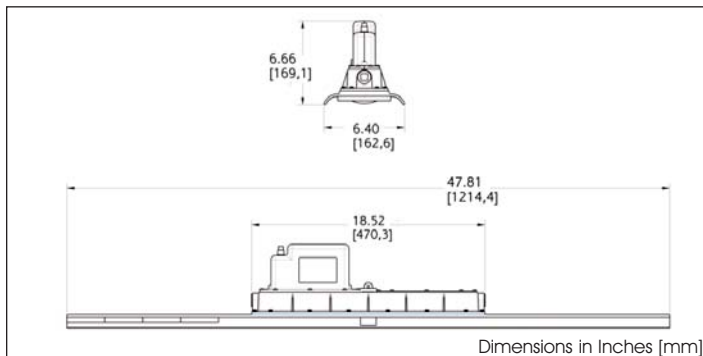

Certifications

- UL 1598/A
- UL 924
- CSA C22.2 #250.0
- IP66
- NEMA 4X

Features & Benefits

- L70 rated for >100,000 hours @ 25°C
- 3 year warranty (excluding battery)
- 450 lumens in battery backup mode consistent throughout life of battery
- Low power consumption
- Battery status indication light
- Instant on/off operation
- Push to test button
- Superior color rendition index compared to HPS, LPS, MV
- Mercury Free
- Resistant to shock and vibration
- Temperature compensation technology for longer life

Application:

Dialight's DuroSite® LED linear fixture replaces HID and fluorescent lighting fixtures in industrial applications. The DuroSite® LED Linear fixture's rugged solid state design makes it highly resistant to shock and vibration. Its fully gasketed IP 66 rated enclosure makes it suitable for dusty & wet locations, its 1598 rating guarantees added protection from salt water spray. The DuroSite LED Linear's superior design allows for mounting versatility and ease of installation for many lighting applications.

This fixture is offered in sustained and maintained configurations.

Sustained has a single AC input and battery backup mode is entered upon any loss of power. Fixture cannot be turned off without entering battery backup mode.

Maintained has two AC inputs. The fixture can be turned on and off via AC-1 and Fixture only enters battery backup mode when AC-2 is lost or low.

Mechanical Information

Fixture Weight:	18.0 lbs (8.16 kg)
Shipping Weight:	21.0 lbs (9.53 kg)
Mounting:	(1) Threaded 3/4" NPT Side (2) Threaded 3/4" NPT Ends

Electrical specifications:

Operating Voltage:	100-277V AC 50/60 Hz
Power Consumption:	85W
Operating Temp:	-20°F to +149°F (-20°C to +65°C)
Battery:	3.6V 10Ah Nimh
Battery Life:	4 years
Battery Duration:	>3 hours
Harmonics:	IEC 61000-3-2
Noise Requirements/ EMC:	FCC Title 47, Subpart B, Section 15, class A device. RF Immunity; 10V/m, 80MHz-1GHz
Surge Protection:	EN 61000-4-5 1 kV line to line 2 kV line to ground

THD: < 20%

Power Factor: > 0.9

Construction

Body: Powder Coated Aluminum

Lens: Polycarbonate

Photometric Information

CRI: 75

CCT: 5650K (cool white)

IES Files: Available upon request

All values typical unless otherwise state
All lumen values are typical (tolerance +/- 10%)

Mounting Options

In-line Conduit Mount



Overhead Conduit Mount



LSXW4



DuroSite® LED Linear Fixtures

Light Distribution Patterns

Standard models

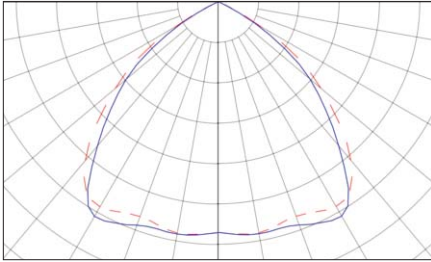

Battery Backup models

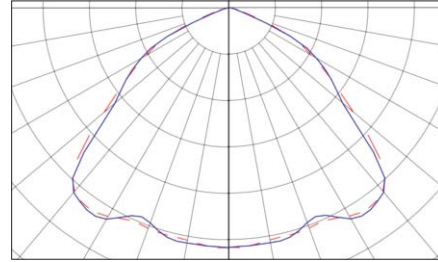

Ordering Information

Part Number	Length	CRI	Type	Lens	Fixture Lumens ^{1,2}	Wattage	Lumens Per Watt
Low profile Models							
LPM3C4M2P	4'	75	Low profile	Clear	7,000	66	106
LPM3C4H2D	4'	75	Low profile	Diffused	6,600	66	100
LPM3B4M2P	4'	80	Low Profile	Clear	6,300	66	95
LPM3B4H2D	4'	80	Low Profile	Diffused	6,000	66	91
LPM3C4D2P	2'	75	Low profile	Clear	3,500	33	106
LPM3C4B2D	2'	75	Low profile	Diffused	3,300	33	100
LPM3B4D2P	2'	80	Low Profile	Clear	3,100	33	94
LPM3B4B2D	2'	80	Low Profile	Diffused	2,900	33	88
Top Conduit Mounting Models							
LTM3C4M2P	4'	75	Top Conduit	Clear	7,000	66	106
LTM3C4H2D	4'	75	Top Conduit	Diffused	6,600	66	100
LTM3B4M2P	4'	80	Top Conduit	Clear	6,300	66	95
LTM3B4H2D	4'	80	Top Conduit	Diffused	6,000	66	91
LTM3C4D2P	2'	75	Top Conduit	Clear	3,500	33	106
LTM3C4B2D	2'	75	Top Conduit	Diffused	3,300	33	100
LTM3B4D2P	2'	80	Top Conduit	Clear	3,100	33	94
LTM3B4B2D	2'	80	Top Conduit	Diffused	2,900	33	88
Battery Backup Models							
LSM3C4MEP	4'	75	Sustained	Clear	7,000	85	85
LSM3C4MNP	4'	75	Maintained	Clear	7,000	85	85

Notes:

¹Part numbers listed in the above table are cool white. For neutral white models replace the 5th character with **N**. Ex. LTM3**C**4D2P becomes LTM3**N**4D2P

²450 Lumens in Battery Backup mode





³All lumen values are typical (tolerance +/- 10%)

For Dialight's complete list of DLC qualified products, please click this link: www.dialight.com/DLC







DuroSite® LED Linear Fixtures

Options and Accessories

Low Profile Models

	Part Number	Material	Description	Kit Includes
Low Profile Models				
				
	LPXW4	316 Stainless Steel	Mounting bracket Can be angled at 0°, 30°, 45°, 60° & 90°	Mounting bracket Mounting hardware
	LPXW4LP	316 Stainless Steel	Low profile mounting bracket Can be angled at 0° and 15°	Mounting bracket Mounting hardware
	LTXENDCAPKIT	304 Stainless Steel	Chain mount and secondary retention bracket	2 Brackets Mounting hardware
	LTXSAFEKIT	304 Stainless Steel	Safety Cable Kit for secondary retention	2 brackets 2 53" Safety cables Mounting hardware





Top Conduit Mount Models

	Part Number	Material	Description	Kit Includes
Standard Models				
				
	LTXW4	6061 Aluminum	Mounting bracket Can be angled at 0°, 30°, 45°, 60° & 90°	Mounting bracket Mounting hardware
	LTXW4LP	5052 Aluminum	Low profile mounting bracket Can be angled at 0° and 15°	Mounting bracket Mounting hardware
	LTXENDCAPKIT	304 Stainless Steel	Chain mount and secondary retention bracket	2 Brackets Mounting hardware
	LTXSAFEKIT	304 Stainless Steel	Safety Cable Kit for secondary retention	2 brackets 2 53" Safety cables Mounting hardware
	LTXLSXW4	6061 Aluminum	Retrofit bracket adapter (used to connect LTM model fixtures to an existing LSXW4 bracket)	2 Bracket adapters Mounting hardware

DuroSite® LED Linear Fixtures

Options and Accessories

Battery Back up Models

Part Number	Material	Description	Kit Includes
Battery Back up Models			
			
	LSXW4 6061 Aluminum	Mounting bracket Can be angled at 0°, 30°, 45°, 60° & 90°	Mounting bracket Mounting hardware
	LSXENDCAPKIT 304 Stainless Steel	Chain mount brackets	2 Mounting brackets Mounting hardware
	HZXSAFEKIT 316 Stainless Steel	Safety Cable Kit	2 Eyelets 2 53" Safety cables Mounting hardware

Battery Backup Wiring Configurations (Optional)



Add one of the following suffixes to the above Part Numbers for factory wired and installed 10' cable and cable gland:

- GS added for installed on one of the side entries (shown to the left)
- GT added for installed on the top entry (not shown)

Ex. LSM3C4D2P becomes LSM3C4D2**PGS**



Add one of the following suffixes to the above Part Numbers for factory wired and installed 10' cable and 3/4" conduit fitting.:

- CT added for installed on the top entry (shown to the left)
- CS added for installed on one the side entries (not shown)

Ex. LSM3C4D2P becomes LSM3C4D2**PCT**

Dialight reserves the right to make changes at any time in order to supply the best product possible. The most current version of this document will always be available at: www.dialight.com/Assets/Brochures_And_Catalogs/Illumination/MDTDLINX001.pdf
 Warranty Statement: EXCEPT FOR THE WARRANTY EXPRESSLY PROVIDED FOR [HEREIN/ABOVE/BELOW], DIALIGHT DISCLAIMS ANY AND ALL OTHER WARRANTIES, EXPRESS OR IMPLIED, INCLUDING, WITHOUT LIMITATION, ANY WARRANTIES OF MERCHANTABILITY, FITNESS FOR A PARTICULAR PURPOSE, TITLE, AND NONINFRINGEMENT.

DuroSite® LED Linear Fixture - UL / CSA
for Indoor and Outdoor Industrial Applications

