

SafeSite® LED Area Light

100-277 VAC, 120-250 VDC



Certifications & Ratings*

- 10 year warranty
- L70 > 150,000 hours @ 65°C
- UL 844, UL 1598/A
- CSA C22.2 No. 250
- CSA C22.2 No. 137-M81
- IP66 / 67 / 69
- NEMA 4X
- Factory sealed

ALD/ALF:

- Class I, Div. 2, Groups A, B, C, D
- Class I, Zone 2, Group IIC
- Class II, Div. 1, Groups E, F, G
- Zone 20 and 21
- Class II, Div. 2 Groups F, G
- Zone 22
- Class III, Div. 1 & 2

*ETL listed

Tempered Glass Lens

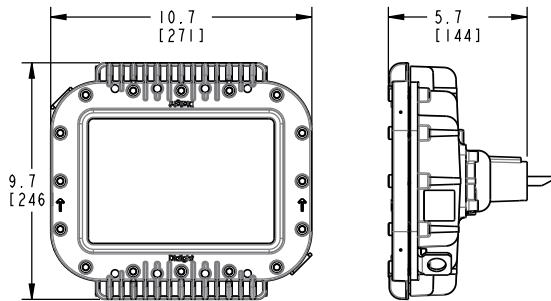

Polycarbonate Lens

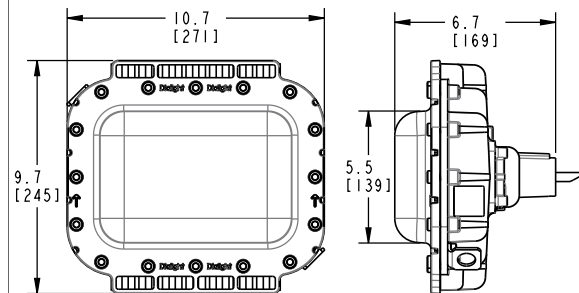

Dimensions in inches [mm]

Additional dimensional drawings on pages 30-35

Mechanical Information:

Fixture weight: 10 lb (4.5 kg) - Polycarbonate lens
12 lb (5.5 kg) - Tempered glass lens
with stainless steel bracket: 13 lb (5.9 kg) - Polycarbonate lens
15 lb (6.8 kg) - Tempered glass lens

Shipping weight: Add 2 lb (0.91 kg) to weights above

Impact rating: IK10 - Polycarbonate lens
IK07 - Tempered glass lens

Cabling: 10' STOOW 1.02mm 18 AWG

Electrical Specifications:

Operating voltage: 100-277 VAC 50/60Hz, 120-250 VDC

Total system power consumption: See table

Operating temperature: -40°F to +149°F (-40°C to +65°C)

EMC: FCC Title 47, Subpart B, Section 15, Class A device
CISPR-15
RF Immunity 20V/m 80MHz-1GHz.

Transient protection: 6 kV, 2 Ohm line-line and line-ground

Harmonics: IEC 61000-3-2, Class C

THD: < 20%

Power factor: > 0.9

Construction:

Housing: Copper-free aluminum

Finish: Superior dual coat finish
- Sealed polyester topcoat
- Epoxy primer

Lens: Hard-coated polycarbonate
Tempered glass

Photometric Information:

CRI: 80

CCT: 5000K (cool white)
4000K (neutral white)

Optics: 360°
180° forward throw for 45° mounting
Wide for 0° mounting

All values typical unless otherwise stated (tolerance +/- 10%)

Temperature Ratings

Ambient Temperature Range T4A

Ambient Temperature Range T5

-40°F to +149°F (-40°C to +65°C)

-40°F to +113°F (-40°C to +45°C)

WARNING - INSTALLATION & SECONDARY RETENTION. Use of any Dialight products without proper installation (including secondary retention / netting) and periodic inspections could cause severe injury or death. Dialight recommends that all installations should use secondary retention / netting (appropriate to the installation environment) where applicable. It is the exclusive responsibility of the contractor, installer and/or end-user to: (a) determine the suitability of the product for its intended application; and, (b) ensure that the product is safely installed (with secondary retention / netting where appropriate) and in compliance with all applicable laws and regulations. To the extent permissible under applicable laws, Dialight disclaims all liability for personal injury and/or other damage resulting from any dislodgment or other dislocation of its products.

SafeSite® LED Area Light

100-277 VAC, 120-250 VDC with Universal Mounting Adapter

Universal Mounting Adapter

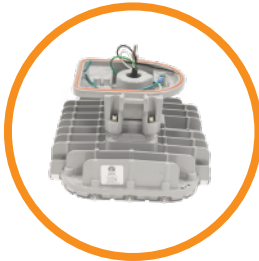

For use with HZXW01, HZXW45, HZXS45 or HZXFM brackets sold separately



HZXW01



HZXS45



HZXS90 / HZXT90



HZXCV34



HZXW45



HZXFM

Wall & Ceiling Mount

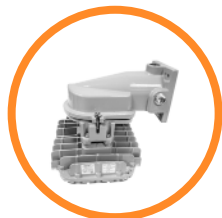

45° Wall Mount

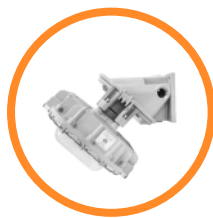

45° Stanchion Mount

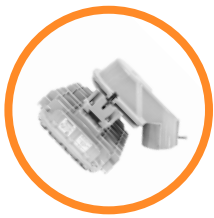

Ceiling Mount



Conveyor Mount



90° Stanchion Mount



Certifications & Ratings*

- 10 year warranty
- L70 > 150,000 hours @ 65°C
- UL 844, UL 1598/A
- CSA C22.2 No. 250
- CSA C22.2 No. 137-M81
- IP66 / 67
- NEMA 4X
- Factory sealed

ALD/ALF:

- Class I, Div. 2, Groups A, B, C, D
- Class I, Zone 2, Group IIC
- Class II, Div. 1, Groups E, F, G
- Zone 20 and 21
- Class II, Div. 2 Groups F, G
- Zone 22
- Class III, Div. 1 & 2

*ETL listed

Additional dimensional drawings on pages 30-35

WARNING - INSTALLATION & SECONDARY RETENTION. Use of any Dialight products without proper installation (including secondary retention / netting) and periodic inspections could cause severe injury or death. Dialight recommends that all installations should use secondary retention / netting (appropriate to the installation environment) where applicable. It is the exclusive responsibility of the contractor, installer and/or end-user to: (a) determine the suitability of the product for its intended application; and, (b) ensure that the product is safely installed (with secondary retention / netting where appropriate) and in compliance with all applicable laws and regulations. To the extent permissible under applicable laws, Dialight disclaims all liability for personal injury and/or other damage resulting from any dislodgment or other dislocation of its products.

Mechanical Information:

Fixture weight:

UMA models:	12 lb (5.5 kg) - Polycarbonate lens
	15 lb (6.8 kg) - Tempered glass lens
Wall mount models:	15 lb (6.8 kg) - Polycarbonate lens
	18 lb (8.2 kg) - Tempered glass lens
45° wall mount models:	14 lb (6.4 kg) - Polycarbonate lens
	17 lb (7.7 kg) - Tempered glass lens
45° stanchion mount:	15 lb (6.8 kg) - Polycarbonate lens
	18 lb (8.2 kg) - Tempered glass lens
Ceiling mount:	14 lb (6.4 kg) - Polycarbonate lens
	7 lb (7.7 kg) - Tempered glass lens
90° stanchion mount:	16 lb (7.2 kg) - Polycarbonate lens
	19 lb (8.6 kg) - Tempered glass lens

Shipping weight:

Add 2 lb (0.91 kg) to weights above

Cabling:

14" leads 1.02 mm 18 AWG

Impact rating:

IK10 - Polycarbonate lens
IK07 - Tempered glass lens

Electrical Specifications:

Operating voltage:	100-277 VAC 50/60Hz, 120-250 VDC
Operating temperature:	-40°F to +149°F (-40°C to +65°C)
EMC:	FCC Title 47, Subpart B, Section 15, Class A device CISPR-15 RF Immunity 20V/m 80MHz-1GHz.
Transient protection:	6 kV, 2 Ohm line-line and line-ground
Harmonics:	IEC 61000-3-2, Class C
THD:	< 20%
Power factor:	> 0.9

Construction:

Housing:	Copper-free aluminum
Finish:	Superior dual coat finish - Sealed polyester topcoat - Epoxy primer
Lens:	Hard-coated polycarbonate Tempered glass

Photometric Information:

CRI:	80
CCT:	5000K (cool white) 4000K (neutral white)
Optics:	360° 180° forward throw for 45° mounting Wide for 0° mounting

All values typical unless otherwise stated (tolerance +/- 10%)

Temperature Ratings

Ambient Temperature Range T4A

Ambient Temperature Range T5

-40°F to +149°F (-40°C to +65°C)

-40°F to +113°F (-40°C to +45°C)

SafeSite® LED Area Light

100-277 VAC, 120-250 VDC



Project Information	
Part Number:	
Project:	
Fixture Type:	Date:

Specifications

Ordering Information

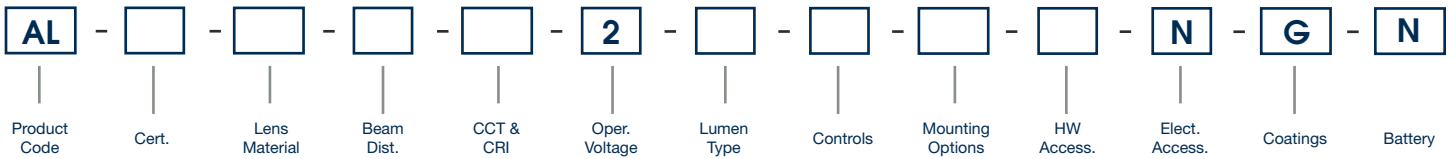

Product Code

AL Area Light

Certification

D UL 844 Class I, Div. 2
Class II, Div. 1, 2, Class III, Div. 1, 2
Class I, Zone 2, Group IIC,
CSA C22.2 No. 137-M81

F UL 844 Class II Div. 1, 2
Class I Div. 2, Class III, Div. 1,2
CSA C22.2 No. 137- M81

Lens Material

5 Polycarbonate - Diffused

7 Tempered Glass - Clear

Beam Distribution

A 180°

B 360°

W Wide

CCT & CRI

C Cool White 5000K - 80 CRI

N Neutral White 4000K - 80 CRI

Operating Voltage

2 100-277 VAC, 120-250 VDC

Lumen Type

3 3,100 Lumens

4 4,200 Lumens

6 5,700 Lumens

7 7,300 Lumens

9 9,000 Lumens

*For lumen output see page 21

Controls

D Dimming (0-10V)

N No Option

Mounting Options

Retro-fit Adapter

Universal Mounting Adapter (UMA)

B Swivel Bracket, Locking 0°- 90°
316 Stainless Steel

N 3/4" NPT Pendant

A Appleton Mercmaster III

C Crouse-Hinds - Champ

G GE Filtr-Gard

H Thomas & Betts Hazlux

K Killark Certilite & Certilite V

M Appleton Mercmaster II

P Holophane Petrolux II and III

F Ceiling Mount

S 45° Stanchion Mount

T 90° Stanchion Mount (NPT)

U UMA - Mounting Hub

V 0° Wall Mount

W 45° Wall Mount

Y 34mm Conveyor Mount

Hardware Accessories

N For Mounting Options -
A, C, F, G, H, K, M, S, U, V, W, Y
(individual wire leads are terminated
in adapter housing)

W 10 ft (3 meter) Power Cable for
Mounting Options - B, N

Electrical Accessories

N No Option

Coatings

G Gray (RAL 7040)

Battery

N No Option

Notes

1) For DLC approved model, dimming option is required.

2) When ordering Beam Distribution W - Wide: Lumen Type = 7.

3) When ordering Mounting Options "UMA" or "Retro-fit": Hardware Accessories = N.

4) When ordering Mounting Option U - UMA Mounting Hub HZXW01, HZXW45, HZXS45, HZXT90, HZXF01 or HZXC34 are required. See page 28 for details.

5) Lumen outputs shown are for Tempered Glass lens, 360° optic. For additional options please see page 21.

DISCLAIMER. All product information provided is, to the best of Dialight's knowledge, accurate as of the date of publication. When ordering, refer to www.dialight.com for current versions of: (a) relevant product documentation (including the relevant product data sheets); (b) Dialight terms and conditions of sale; and, (c) the relevant product warranty. To the extent that any contract is deemed formed between Dialight and the purchaser of Dialight products and/or an end-user, versions of documents available at www.dialight.com as at the date of sale shall be the versions incorporated therein. In the event of any discrepancy between this document or information provided at www.dialight.com, the latter shall prevail.

Ordering Information

SafeSite® LED Area Light - 100-277 VAC, 120-250 VDC



100-277 VAC, 120-250 VDC Model								
Part Number	Initial Fixture Lumens	Wattage	lm/W	CCT	Lens	Beam Distribution	Controls Option	Mounting
ALD-7AC2-9NNW-NGN	8,800	66	133	CW	Tempered Glass	180°	No Option	3/4" NPT
ALD-5AC2-9NNW-NGN	8,100	66	123	CW	Polycarbonate Diffused	180°	No Option	3/4" NPT
ALD-7BC2-9NNW-NGN	9,000	66	136	CW	Tempered Glass	360°	No Option	3/4" NPT
ALD-5BC2-9NNW-NGN	8,300	66	126	CW	Polycarbonate Diffused	360°	No Option	3/4" NPT
ALD-7AC2-7NNW-NGN	7,100	52	137	CW	Tempered Glass	180°	No Option	3/4" NPT
ALD-5AC2-7NNW-NGN	6,600	52	127	CW	Polycarbonate Diffused	180°	No Option	3/4" NPT
ALD-7BC2-7NNW-NGN	7,300	52	140	CW	Tempered Glass	360°	No Option	3/4" NPT
ALD-5BC2-7NNW-NGN	6,700	52	129	CW	Polycarbonate Diffused	360°	No Option	3/4" NPT
ALD-7WC2-7NNW-NGN	7,300	64	114	CW	Tempered Glass	Wide	No Option	3/4" NPT
ALD-5WC2-7NNW-NGN	6,700	64	105	CW	Polycarbonate Diffused	Wide	No Option	3/4" NPT
ALD-7AC2-6NNW-NGN	5,500	40	138	CW	Tempered Glass	180°	No Option	3/4" NPT
ALD-5AC2-6NNW-NGN	5,100	40	128	CW	Polycarbonate Diffused	180°	No Option	3/4" NPT
ALD-7BC2-6NNW-NGN	5,700	40	143	CW	Tempered Glass	360°	No Option	3/4" NPT
ALD-5BC2-6NNW-NGN	5,300	40	133	CW	Polycarbonate Diffused	360°	No Option	3/4" NPT
ALD-7AC2-4NNW-NGN	4,100	30	137	CW	Tempered Glass	180°	No Option	3/4" NPT
ALD-5AC2-4NNW-NGN	3,800	30	127	CW	Polycarbonate Diffused	180°	No Option	3/4" NPT
ALD-7BC2-4NNW-NGN	4,200	30	140	CW	Tempered Glass	360°	No Option	3/4" NPT
ALD-5BC2-4NNW-NGN	3,900	30	130	CW	Polycarbonate Diffused	360°	No Option	3/4" NPT
ALD-7AC2-3NNW-NGN	3,000	24	125	CW	Tempered Glass	180°	No Option	3/4" NPT
ALD-5AC2-3NNW-NGN	2,800	24	117	CW	Polycarbonate Diffused	180°	No Option	3/4" NPT
ALD-7BC2-3NNW-NGN	3,100	24	129	CW	Tempered Glass	360°	No Option	3/4" NPT
ALD-5BC2-3NNW-NGN	2,800	24	117	CW	Polycarbonate Diffused	360°	No Option	3/4" NPT
100-277 VAC, 120-250 VDC Model with Retro-fit Adapters - Crouse Hinds								
ALD-7BC2-7NCN-NGN	7,300	52	140	CW	Tempered Glass	360°	No Option	Retro-fit: Crouse Hinds
ALD-5BC2-7NCN-NGN	6,700	52	129	CW	Polycarbonate Diffused	360°	No Option	Retro-fit: Crouse Hinds
ALD-7BC2-6NCN-NGN	5,700	40	143	CW	Tempered Glass	360°	No Option	Retro-fit: Crouse Hinds
ALD-5BC2-6NCN-NGN	5,300	40	133	CW	Polycarbonate Diffused	360°	No Option	Retro-fit: Crouse Hinds
100-277 VAC, 120-250 VDC Model with Retro-fit Adapters - GE								
ALD-7BC2-7NGN-NGN	7,300	52	140	CW	Tempered Glass	360°	No Option	Retro-fit: GE
ALD-5BC2-7NGN-NGN	6,700	52	129	CW	Polycarbonate Diffused	360°	No Option	Retro-fit: GE
ALD-7BC2-6NGN-NGN	5,700	40	143	CW	Tempered Glass	360°	No Option	Retro-fit: GE
ALD-5BC2-6NGN-NGN	5,300	40	133	CW	Polycarbonate Diffused	360°	No Option	Retro-fit: GE

See ordering chart for additional options.

For DLC-approved products that require 0-10V dimming, replace the 9th character "N" with "D". ALU-7BC2-9NNW-NGN becomes ALU-7BC2-9DNW-NGN. 0-10V dimming products are supplied with a 5 conductor cable.

DISCLAIMER. All product information provided is, to the best of Dialight's knowledge, accurate as of the date of publication. When ordering, refer to www.dialight.com for current versions of: (a) relevant product documentation (including the relevant product data sheets); (b) Dialight terms and conditions of sale; and, (c) the relevant product warranty. To the extent that any contract is deemed formed between Dialight and the purchaser of Dialight products and/or an end-user, versions of documents available at www.dialight.com as at the date of sale shall be the versions incorporated therein. In the event of any discrepancy between this document or information provided at www.dialight.com, the latter shall prevail.

Ordering Information

SafeSite® LED Area Light - 100-277 VAC, 120-250 VDC

with Universal Mounting Adapter



100-277 VAC, 120-250 VDC with Universal Mounting Adapter

Part Number	Initial Fixture Lumens	Wattage	lm/W	CCT	Lens	Beam Distribution	Controls Option	Mounting
ALD-7AC2-7NUN-NGN	7,100	52	137	CW	Tempered Glass	180°	No Option	UMA Hub
ALD-5AC2-7NUN-NGN	6,600	52	127	CW	Polycarbonate Diffused	180°	No Option	UMA Hub
ALD-7BC2-7NUN-NGN	7,300	52	140	CW	Tempered Glass	360°	No Option	UMA Hub
ALD-5BC2-7NUN-NGN	6,700	52	129	CW	Polycarbonate Diffused	360°	No Option	UMA Hub
ALD-7AC2-6NUN-NGN	5,500	40	138	CW	Tempered Glass	180°	No Option	UMA Hub
ALD-5AC2-6NUN-NGN	5,100	40	128	CW	Polycarbonate Diffused	180°	No Option	UMA Hub
ALD-7BC2-6NUN-NGN	5,700	40	143	CW	Tempered Glass	360°	No Option	UMA Hub
ALD-5BC2-6NUN-NGN	5,300	40	133	CW	Polycarbonate Diffused	360°	No Option	UMA Hub
ALD-7AC2-7NSN-NGN	7,100	52	137	CW	Tempered Glass	180°	No Option	45° Stanchion
ALD-5AC2-7NSN-NGN	6,600	52	127	CW	Polycarbonate Diffused	180°	No Option	45° Stanchion
ALD-7AC2-6NSN-NGN	5,500	40	138	CW	Tempered Glass	180°	No Option	45° Stanchion
ALD-5AC2-6NSN-NGN	5,100	40	128	CW	Polycarbonate Diffused	180°	No Option	45° Stanchion
ALD-7AC2-4NSN-NGN	4,100	30	137	CW	Tempered Glass	180°	No Option	45° Stanchion
ALD-5AC2-4NSN-NGN	3,800	30	127	CW	Polycarbonate Diffused	180°	No Option	45° Stanchion
ALD-7AC2-7NWN-NGN	7,100	52	137	CW	Tempered Glass	180°	No Option	45° Wall
ALD-5AC2-7NWN-NGN	6,600	52	127	CW	Polycarbonate Diffused	180°	No Option	45° Wall
ALD-7AC2-6NWN-NGN	5,500	40	138	CW	Tempered Glass	180°	No Option	45° Wall
ALD-5AC2-6NWN-NGN	5,100	40	128	CW	Polycarbonate Diffused	180°	No Option	45° Wall
ALD-7AC2-4NWN-NGN	4,100	30	137	CW	Tempered Glass	180°	No Option	45° Wall
ALD-5AC2-4NWN-NGN	3,800	30	127	CW	Polycarbonate Diffused	180°	No Option	45° Wall
ALD-7AC2-7NVN-NGN	7,100	52	137	CW	Tempered Glass	180°	No Option	0° Wall
ALD-5AC2-7NVN-NGN	6,600	52	127	CW	Polycarbonate Diffused	180°	No Option	0° Wall
ALD-7AC2-6NVN-NGN	5,500	40	138	CW	Tempered Glass	180°	No Option	0° Wall
ALD-5AC2-6NVN-NGN	5,100	40	128	CW	Polycarbonate Diffused	180°	No Option	0° Wall
ALD-7AC2-4NVN-NGN	4,100	30	137	CW	Tempered Glass	180°	No Option	0° Wall
ALD-5AC2-4NVN-NGN	3,800	30	127	CW	Polycarbonate Diffused	180°	No Option	0° Wall
ALD-7BC2-7NFN-NGN	7,100	52	137	CW	Tempered Glass	360°	No Option	Ceiling Mount
ALD-5BC2-7NFN-NGN	6,600	52	127	CW	Polycarbonate Diffused	360°	No Option	Ceiling Mount
ALD-7BC2-6NFN-NGN	5,500	40	138	CW	Tempered Glass	360°	No Option	Ceiling Mount
ALD-5BC2-6NFN-NGN	5,100	40	128	CW	Polycarbonate Diffused	360°	No Option	Ceiling Mount
ALD-7BC2-4NFN-NGN	4,100	30	137	CW	Tempered Glass	360°	No Option	Ceiling Mount
ALD-5BC2-4NFN-NGN	3,800	30	127	CW	Polycarbonate Diffused	360°	No Option	Ceiling Mount

See ordering chart for additional options.

For DLC-approved products that require 0-10V dimming, replace the 9th character "N" with "D". ALU-7BC2-9NNW-NGN becomes ALU-7BC2-9DNW-NGN. 0-10V dimming products are supplied with a 5 conductor cable.

DISCLAIMER. All product information provided is, to the best of Dialight's knowledge, accurate as of the date of publication. When ordering, refer to www.dialight.com for current versions of: (a) relevant product documentation (including the relevant product data sheets); (b) Dialight terms and conditions of sale; and, (c) the relevant product warranty. To the extent that any contract is deemed formed between Dialight and the purchaser of Dialight products and/or an end-user, versions of documents available at www.dialight.com as at the date of sale shall be the versions incorporated therein. In the event of any discrepancy between this document or information provided at www.dialight.com, the latter shall prevail.